

TITANIUM

TECHNOLOGY

TT-14-3000-O



- Aluminum profile with opal acrylic.
- Designed to cover and dissipate heat of the LED strips.
- Available in lengths 3000 mm (118¹/₈").

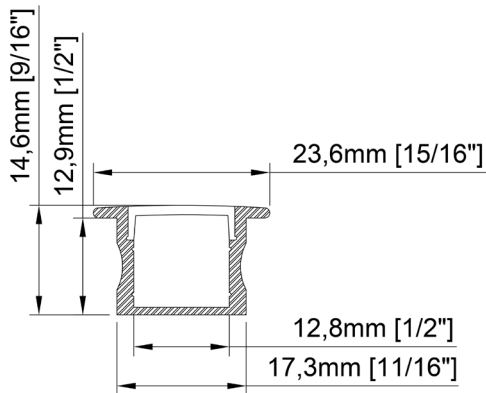

Size	17,3mm x 12,9mm x 3000mm 11/16" x 1/2" x 118 ¹ / ₈ "
Lenght	3000mm 118 ¹ / ₈ "
Internal width	12,8mm 1/2"
Cover	Matte Opal PMMA Clear PMMA Black PMMA PC diffuser

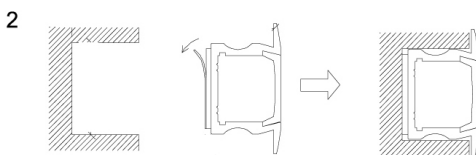
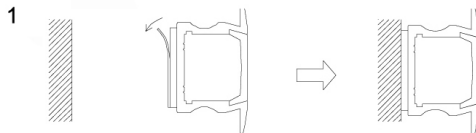

Accessories



TT-14-CLIP



TT-14-END

PRODUCT CODE

TT	-	MODEL	-	LENGHT (mm)	-	COVER
TT	-	14	-	3000	-	O

Electrical connections / Connexions électriques

1. ⚠️ WARNING : RISK OF ELECTRIC SHOCK / ATTENTION : RISQUE DE CHOC ÉLECTRIQUE ⚠️

To avoid the risk of electric shock, turn off the power at the electrical panel before doing any installation or maintenance.
The installation must comply with the electrical code in force in your region.

Pour éviter les risques de choc électrique, couper l'alimentation à partir du panneau électrique avant de faire l'installation ou l'entretien.
L'installation doit être conforme au code électrique en vigueur dans votre région.

2. LOW VOLTAGE CONNECTION / BRANCHEMENT DU BAS VOLTAGE

A. CONNECTION IN THE TT-DR-CV / RACCORDEMENT DANS BOÎTIER TT-DR-CV

- Remove the plastic cover from the DC side
- Insert and secure in the V- terminal block the black wire coming from the led strip.
- Insert and fix in the V+ terminal block + the red or white wire coming from the led strip.
- Replace the plastic cover on the transformer.

- Retirer le couvercle de plastique du côté DC
- Insérer et fixer dans le bornier V- le fil noir provenant du ruban del
- Insérer et fixer dans le bornier V+ le fil rouge ou blanc provenant du ruban del
- Replacer le couvercle de plastique sur le transformateur.

B. CONNECTION IN TT-DR-CV-BOX / RACCORDEMENT DANS BOÎTIER TT-DR-CV-BOX

- Remove the housing cover
- Install a cable gland in the appropriate opening of the housing on the DC side
- Insert the cable of the led strip into the DC compartment of the housing via the cable gland
- Join the black wire of the output of the transformer to the black wire of the led strip
- Join the red or white wire of the output of the transformer to the white or red wire of the led tape
- Close the housing cover.

- Retirer le couvercle du boîtier
- Installer un presse-étoupe dans l'ouverture appropriée du boîtier du côté DC
- Insérer le câble du ruban del dans le compartiment DC du boîtier via le presse-étoupe
- Joindre le fil noir de la sortie du transformateur au fil noir du ruban del
- Joindre le fil rouge ou blanc de la sortie du transformateur au fil blanc ou rouge du ruban del
- Refermer le couvercle du boîtier.

C. CONNECTION TO TT-PSU TERMINAL BLOCK / RACCORDEMENT SUR BORNIER TT-PSU

- Attach the black cable of the LED ribbon to the terminal block marked with a V- on the transformer
- Attach the red or white cable from the led strip to the terminal block marked with a V+ on the transformer

- Fixer le câble noir du ruban del au bornier indiqué d'un V- sur le transformateur
- Fixer le câble rouge ou blanc du ruban del au bornier indiqué d'un V+ sur le transformateur

D. CONNECTION WITH PLUG 2.1MM / RACCORDEMENT AVEC FICHE 2.1MM

- Connect the 2.1mm connectors of the led strip and the appropriate DC transformer.
- Brancher les connecteurs 2.1mm du ruban del et du transformateur DC approprié.



3. LINE VOLTAGE CONNECTION / BRANCHEMENT HAUTE TENSION

A. CONNECTION IN THE TT-DR-CV / RACCORDEMENT DANS BOÎTIER TT-DR-CV

- Remove the plastic cover from the AC side
- Insert and fix in terminal block N the white wire coming from the power supply wire
- Insert and fix in the terminal block L the black wire coming from the power supply wire
- Replace the plastic cover on the transformer.

- Retirer le couvercle de plastique du côté AC
- Insérer et fixer dans le bornier N le fil blanc provenant du fil d'alimentation
- Insérer et fixer dans le bornier L le fil noir provenant du fil d'alimentation
- Replacer le couvercle de plastique sur le transformateur.

B. CONNECTION IN TT-DR-CV-BOX / RACCORDEMENT DANS BOÎTIER TT-DR-CV-BOX

- Remove the housing cover
- Install a cable gland in the appropriate opening of the box on the AC side
- Insert the power cable into the AC compartment of the box via the cable gland
- Secure the earth of the power cable to the green earth screw of the housing
- Join the white wires of the transformer and the power cable with a twist-on
- Join the black wires of the transformer and the power cable with a twist-on
- Close the housing cover.

- Retirer le couvercle du boîtier
- Installer un presse-étoupe dans l'ouverture appropriée du boîtier du côté AC
- Insérer le câble d'alimentation dans le compartiment AC du boîtier via le presse-étoupe
- Fixer la mise à la terre du câble d'alimentation à la vis verte de mise à la terre du boîtier
- Joindre les fils blanc du transformateur et du câble d'alimentation avec une marette
- Joindre les fils noir du transformateur et du câble d'alimentation avec une marette
- Refermer le couvercle du boîtier.

C. CONNECTION TO TT-PSU TERMINAL BLOCK / RACCORDEMENT SUR BORNIER TT-PSU

- Check that the voltage selector is on 115V if available
- Secure the earth cable to the terminal block indicated with a Ⓧ
- Attach the white wire of the power cable to the terminal block indicated N on the transformer
- Attach the black wire of the power cable to the terminal block marked with an L on the transformer

- Bien vérifier que le sélecteur de tension soit sur 115V si disponible
- Fixer le câble de mise à la terre au bornier indiqué d'un Ⓧ
- Fixer le fil blanc du câble d'alimentation au bornier indiqué N sur le transformateur
- Fixer le fil noir du câble d'alimentation au bornier indiqué d'un L sur le transformateur

D. CONNECTION WITH PLUG 2.1MM / RACCORDEMENT AVEC FICHE 2.1MM

- Connect the transformer power cord to the electrical outlet.
- Brancher le cordon d'alimentation du transformateur à la prise électrique.



Wiring diagrams / Schémas de branchements

1. LINE VOLTAGE CONNECTION / BRANCHEMENT HAUTE TENSION

TT-PSU serie / 0-10V



TT-DR-CV Serie

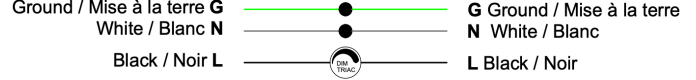

2. LOW VOLTAGE CONNECTION / BRANCHEMENT BASSE TENSION

TT-PSU Serie / TT-DR-CV Serie



0-10V



TT-U-E4S RGBW Controller



TT-DMX-4C with RGB



TT-U-E5S RGBCCT Controller

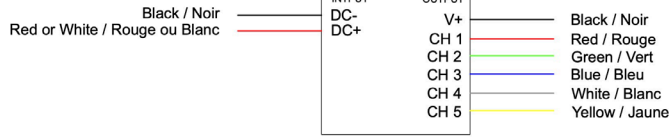

TT-DMX-4C with RGBW

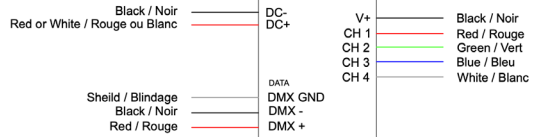

TT-AMP-4-32

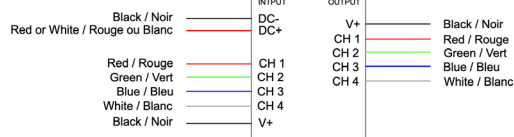

TT-DMX-5C with RGBCCT

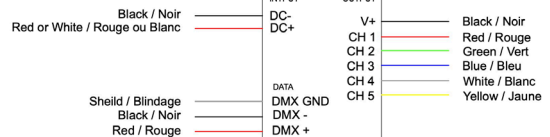

TT-AMP-5-50

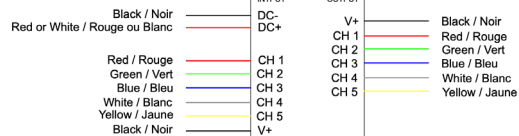

TT-ACC-IR Serie

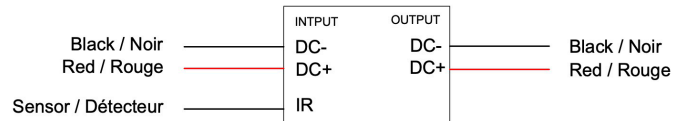

TT-U-M3

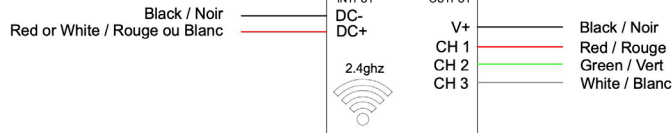

TT-U-02 3way DC

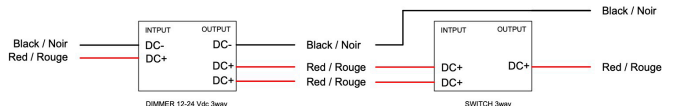

TT-U-M4



TT-U-01 / TT-U-13 / TT-U-14 / TT-U-06

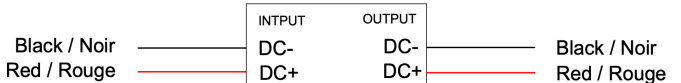

LIMITED ONE (1) YEAR WARRANTY



Titanium Technology offers this limited warranty for one (1) year from the date of purchase of this Titanium Technology product (hereafter : the «Product»). A list of all the Titanium Technology products covered by this limited warranty is given at the end of this document.

This limited warranty is valid only for the Product and it may not be transferred.

The present limited warranty is not meant to exclude, restrict, limit or modify the legal warranty given by law to the purchaser of the Product.

This is a quality Product. It was made and selected with care. If the Product contains a manufacturing defect or if one or more parts of the Product is defective, the retailer commits to replace or repair, at its sole discretion, the defective part of parts without charge under the following cumulative conditions : 1) the purchaser must contact the retail store where the Product was purchased; 2) the purchaser must return the defective part of parts or the Product to the retailer; 3) the purchaser must provide the retailer the invoice as proof of purchase and date of purchase of the Product; 4) the purchaser must supply the Product identification information, including the serial number or the model number; and 5) the period of one (1) year covered by this limited warranty must not be expired. If the retailer decides to replace the defective part or parts, the replacement part or parts would be new or reconditioned, equivalent to new parts.

EXCLUSIONS AND LIMITATIONS OF THE LIMITED WARRANTY

This limited warranty is not applicable :

1. to consumable parts;
2. to normal wear;
3. when the Product is used for purposes other than those determined by the manufacturer;
4. when the Product is not installed by a qualified electrician when electrical work is required;
5. when the serial number or other identification information or the Product is erased or withdrawn;
6. to damages that are only aesthetic and do not affect the normal use of the Product, including scatches, bumps etc.;
7. to labour costs such as installation, de-installation or shipping of the Product which must be paid by the purchaser;
8. to service call costs, when the service call is made while the warranty is not valid;
9. when the damages, defects, faults or other problems arise from :
 - a. an abnormal use of the Product;
 - b. an inadequate maintenance of the Product;
 - c. a faulty installation of the Product or an installation that is not in accordance with the installation guide (if one is provided);
 - d. a modification, a repair or dismantling of the Product by a person not authorized by the retailer or the manufacturer;
 - e. the transportation by the purchaser, his employee, officer or representative;
 - f. a negligence by the purchaser, his employee, officer or representative;
 - g. an accident;
 - h. a case of force majeure (are considered force majeure : nature disasters, lightning, flood, fire etc.);
 - i. any event that is not caused by the Product itself.

In no circumstance can the manufacturer or retailer be held responsible for any extraordinary, special, indirect, accessory or consecutive damages resulting from the use of or the incapacity to use the Product. Their responsibility is limited to the sale price of the Product as indicated on the notice and paid by the purchaser at the time of purchase. It is understood that this is not meant to limit, restrict or exclude the protection given by the legal warranty.

FRENCH VERSION VS ENGLISH VERSION

In case of discrepancy between the French and the English versions of the text of this limited warranty, the French version shall prevail.

MODIFICATIONS

The present warranty text is subject to change at any time.

List of Titanium Technology products covered under this limited warranty :

- | | | |
|--------------------------|--------------------------|-----------------------|
| 1) Nicolaudie Controller | 5) TT-CAB-XX | 9) TT-WiFi |
| 2) LTECH Controller | 6) TT-DMX-XX | 10) Aluminium profile |
| 3) TT-ACC-XX | 7) TT-PSU-IP20 / PLUG-IN | |
| 4) TT-AMP-XX | 8) TT-U-XX | |

Note : This product list may not be up to date. Please refer to the product itself (including the package or installation guide) to make sure it is covered by this limited warranty.