

TITANIUM

TECHNOLOGIE

TT-2216-L1500



- Ruban Del SMD2216 en rouleau de 5 mètres.

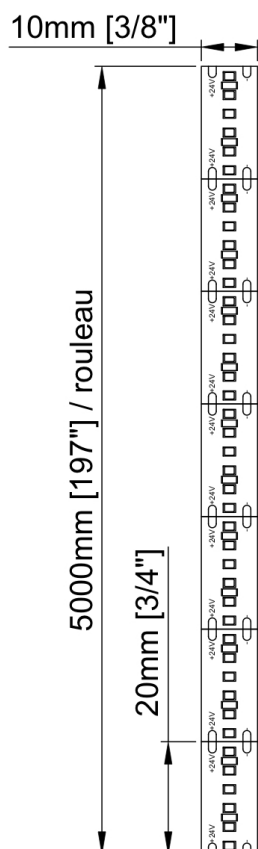

Tension	24vDC	
DEL/m	300 / m	
Puissance	34,12w / m 10,40w / pied 170,56w / rouleau	
Ampérage	1,34 / m 0,44 / pied 7,11 / rouleau	
Lumens	27K - 426 lm / pied 30K - 425 lm / pied 35K - 432 lm / pied 40K - 451 lm / pied 60K - 503 lm / pied	51 lm / w 52 lm / w - - 61 lm / w
IRC	90	
Angle	120°	
Dimension	IP20	10mm x 1,1mm x 5000mm $\frac{3}{8}'' \times \frac{1}{16}'' \times 196\frac{7}{8}''$
	IP65	10mm x 2,5mm x 5000mm $\frac{3}{8}'' \times \frac{1}{8}'' \times 196\frac{7}{8}''$
	IP67	13mm x 5mm x 5000mm $\frac{1}{2}'' \times \frac{3}{16}'' \times 196\frac{7}{8}''$
Ligne de coupe	20 mm $\frac{3}{4}''$	
Finition	Blanc	
Gradable	Oui	
Couleur DEL	27K - Blanc chaud 2700K 30K - Blanc chaud 3000K 35K - Blanc neutre 3500K 40K - Blanc neutre 4000K 60K - Blanc froid 6000K R - Rouge G - Vert B - Bleu A - Ambre	
Temp. fonctionnement	-40°C ~ 70°C	
IP	20, 65, 67	

CODE PRODUIT

TT	SMD	DEL PAR ROULEAU	IP	COULEUR DEL	TENSION
TT	2216	L1500	20	27K	24V
TT	2216	L1500			24V

IES Indoor Report

Photometric Filename:TT-2216-L1500-2700K-3-Milky LENS.IES

Indoor Luminaire Photometric Data

Description Information

Luminaire Name: TT-2216-L1500-2700k-3-Milky lens	Luminaire Catalog:	Test ID:
Lamp Name: TT-2216-L1500-2700k-3-Milky lens	Lamp Catalog: 2216	Test Date: 2021/03/17
Manufacture: TITANIUM TECHNOLOGIE	ShieldingAngle(°):	Test Machine: GON-2000
Test Lab:	Frequency(Hz):	Luminaire CCT(K):
Luminaire Size(W*L*H): 0.120*0.304*0.060	Lighting Area(m2): 0.055	Luminaire Weight(kg): 0.100
Test System: C, γ	Test Step: C=45.0 γ =1.0	Temperature(°C): 25
		Humidity(%):

Character Parameter

Lamp Speciality Parameter	
Lamp Rated Lumens(lm): 448.000	Lamp Number in Luminaire: 1
Lamp Norminal Power(W):	Lamp Rated Voltage(V):
Lamp Tested Power(W): 8.484	Lamp Tested Voltage(V): 24.5
Lamp Tested Current(A): 0.345	Lamp Tested PF:
Lamp Size(W*L*H): 0.120*0.304*0.060	
Luminaire Speciality	
Luminaire Lumens(lm): 171.315	Beam Angle(10%Imax): 102.1
Luminaire Efficiency: 38.24%	Left=-49.2 Right=52.9
Luminaire EER(lm/W): 20.193	Field Angle(10%Imax): 142.7
Muximum Cand.(cd): 73.584	Spacing Criteria S/MH(C0_180): 1.215
Max Cd. Angle(°): C=315.0 γ =3.0	Spacing Criteria S/MH(C90_270): 1.223
Downward Lumens(lm): 171.315	CIE Type: Semi-Direct
Upward Lumens(lm): 0.000	ErP ϕ use(120deg): 151.805lm
Downward Total Efficiency%: 100.00	IRF(%): 116.279
Upward Total Efficiency%: 0.00	

IES Indoor Report

Photometric Filename: TT-2216-L1500-2700K-3-Milky LENS.IES

2D Light Intensity Distribution Curve

Plane	[50%Ang.]	[10%Ang.]
C315.0:	102.1	142.7
C0.0:	101.7	141.5
C90.0:	102.5	142.8

Polar Graph

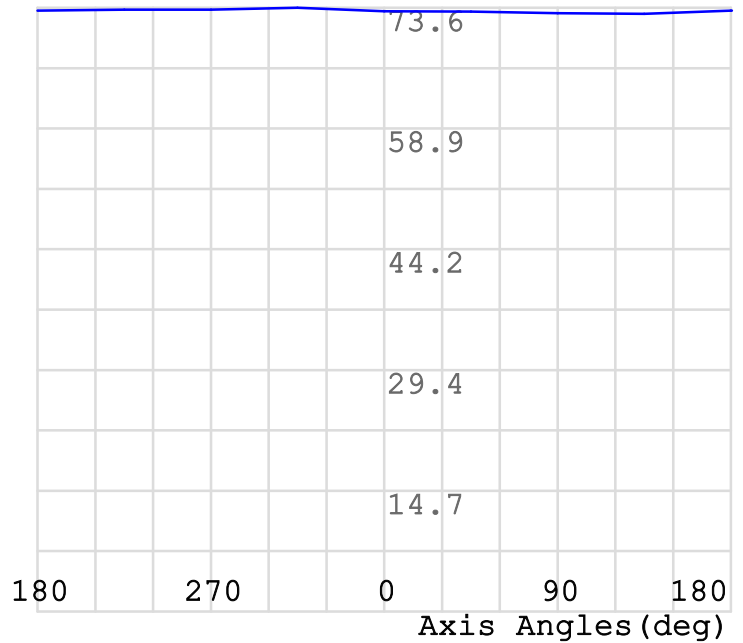
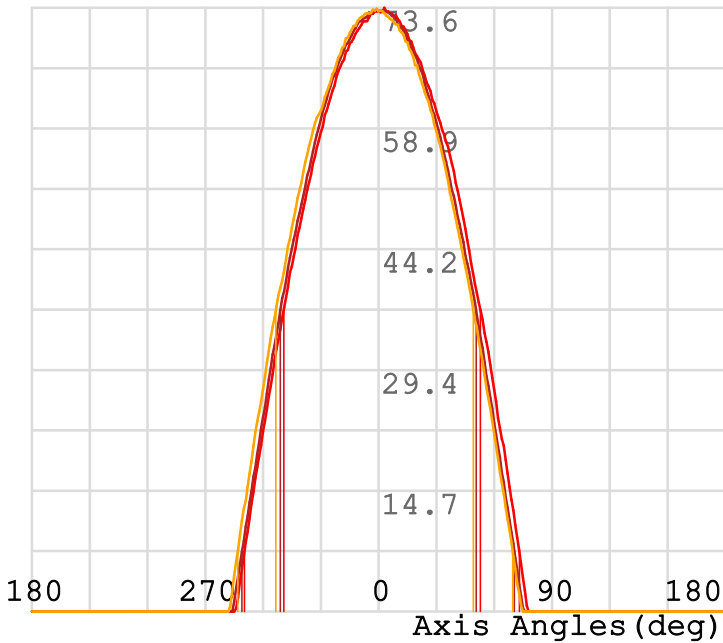
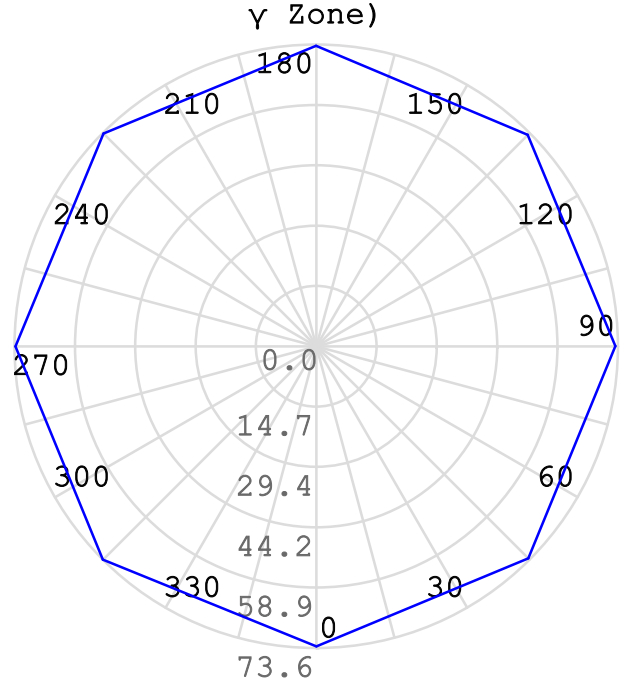
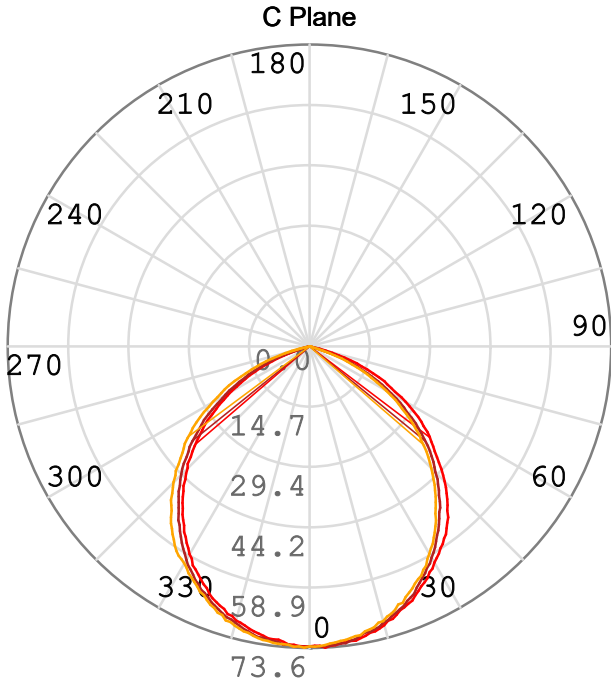

C Plane: C315.0_135.0 ——— C0.0_180.0 ——— C90.0_270.0 ———
 γ Cone: γ3.0 ———

IES Indoor Report

Photometric Filename: TT-2216-L1500-2700K-3-Milky LENS.IES

3D Light Intensity Distribution Curve

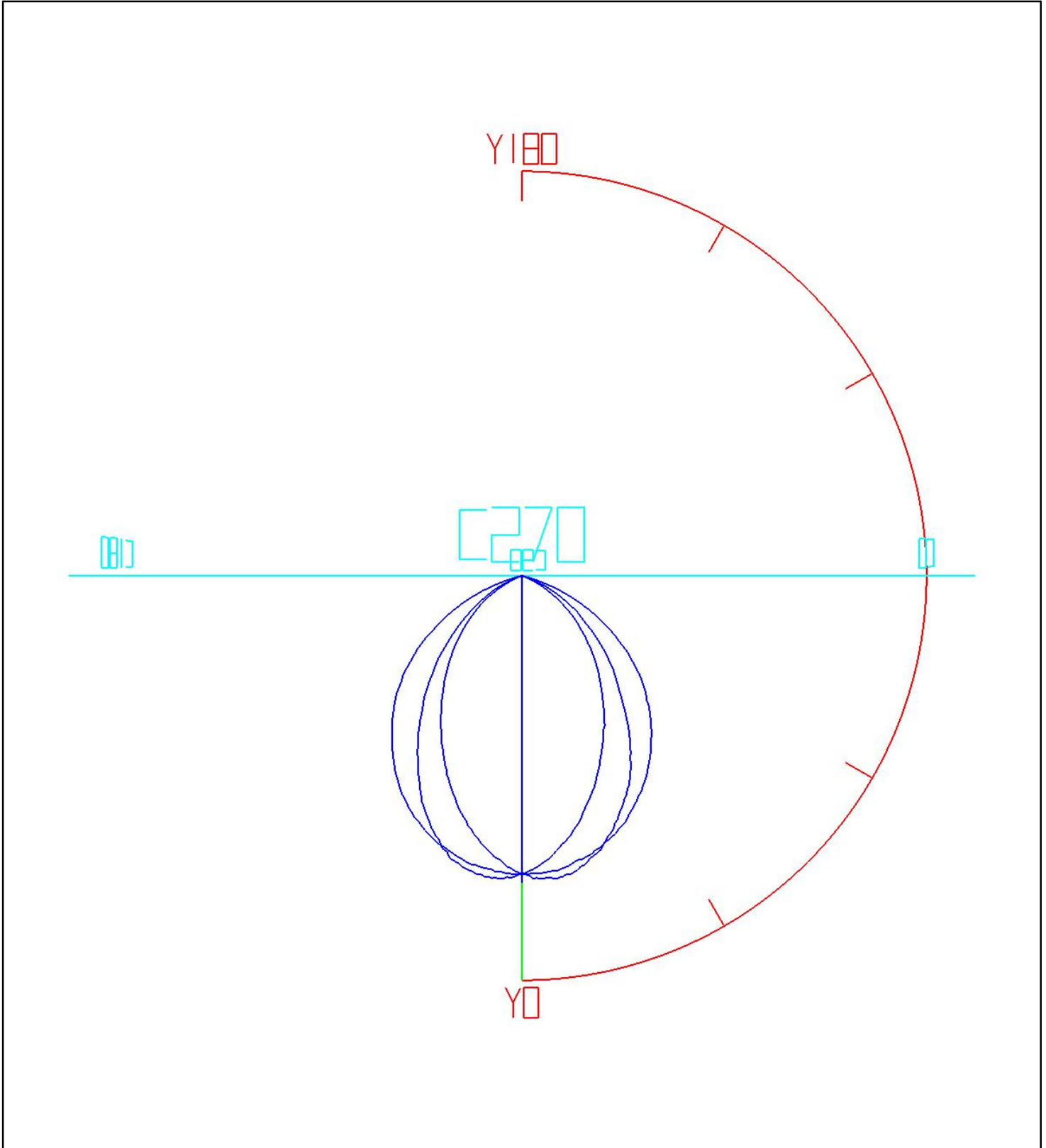

Curves: 3D Model ——— Fixture ——— Vert. HUD ——— Hori. HUD ———
View Angles: Orient:0 Tilt:0 Roll:0 Spin:0

IES Indoor Report

Photometric Filename: TT-2216-L1500-2700K-3-Milky LENS.IES

Rectangle ISO Light Intensity Curve

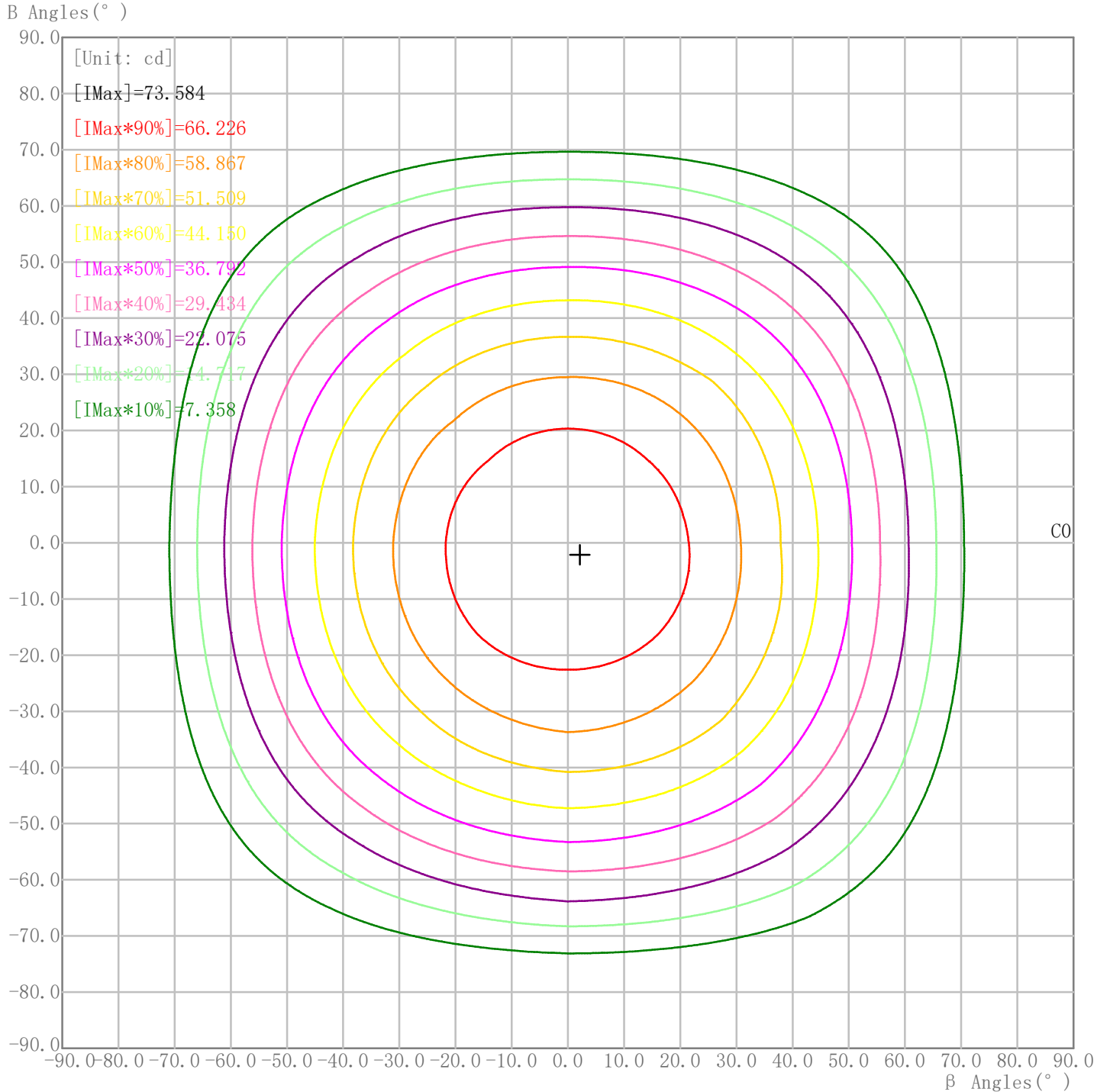

Curves: 90% — 80% — 70% — 60% — 50% — 40% — 30% — 20% — 10% —
Maximum Light Intensity(cd): 73.58 Maximum Cd. Angles: H2.1 V-2.1

IES Indoor Report

Photometric Filename: TT-2216-L1500-2700K-3-Milky LENS.IES

Plane ISO-Illuminance Curve

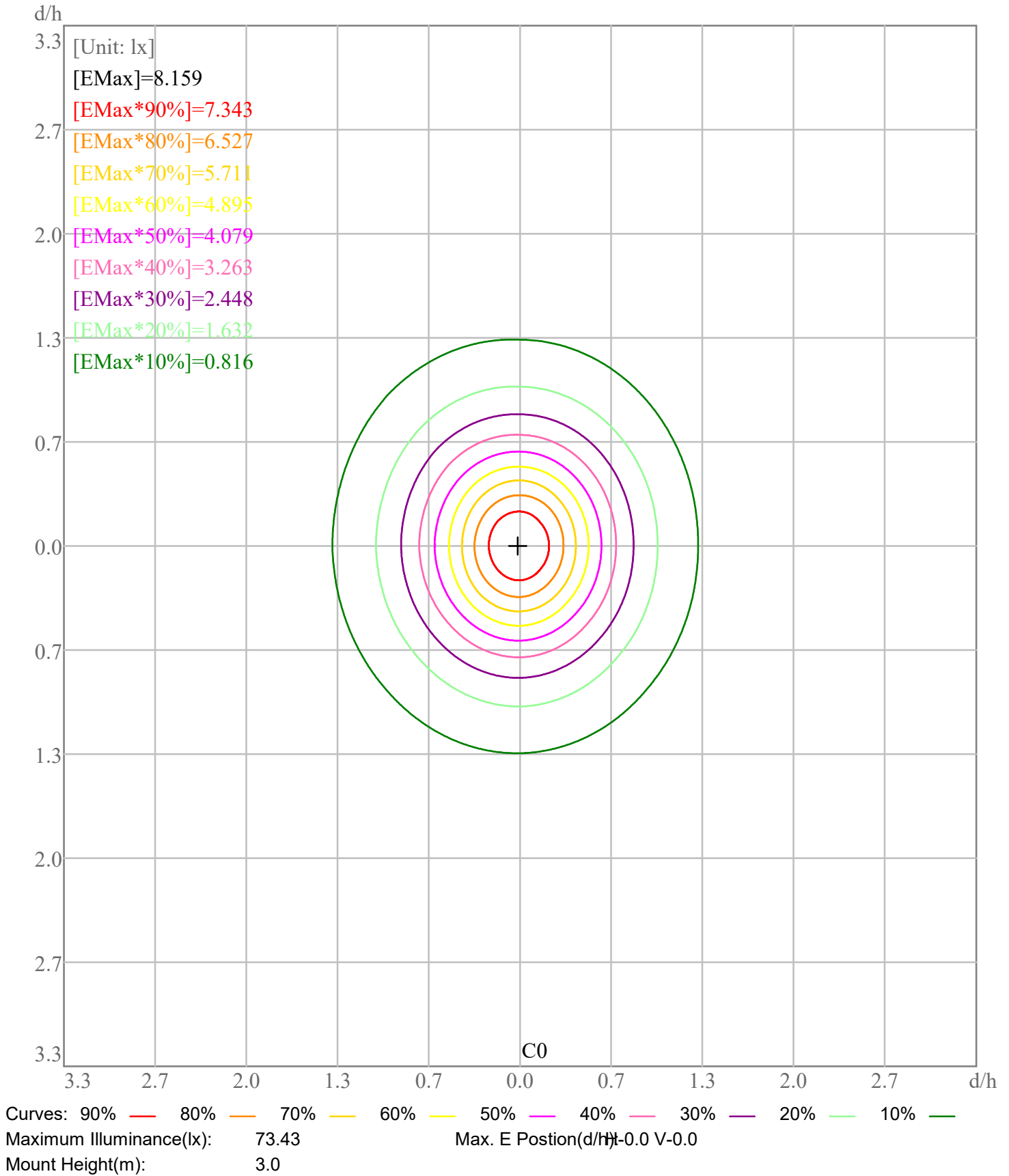

3D Plane ISO Illuminance Curve

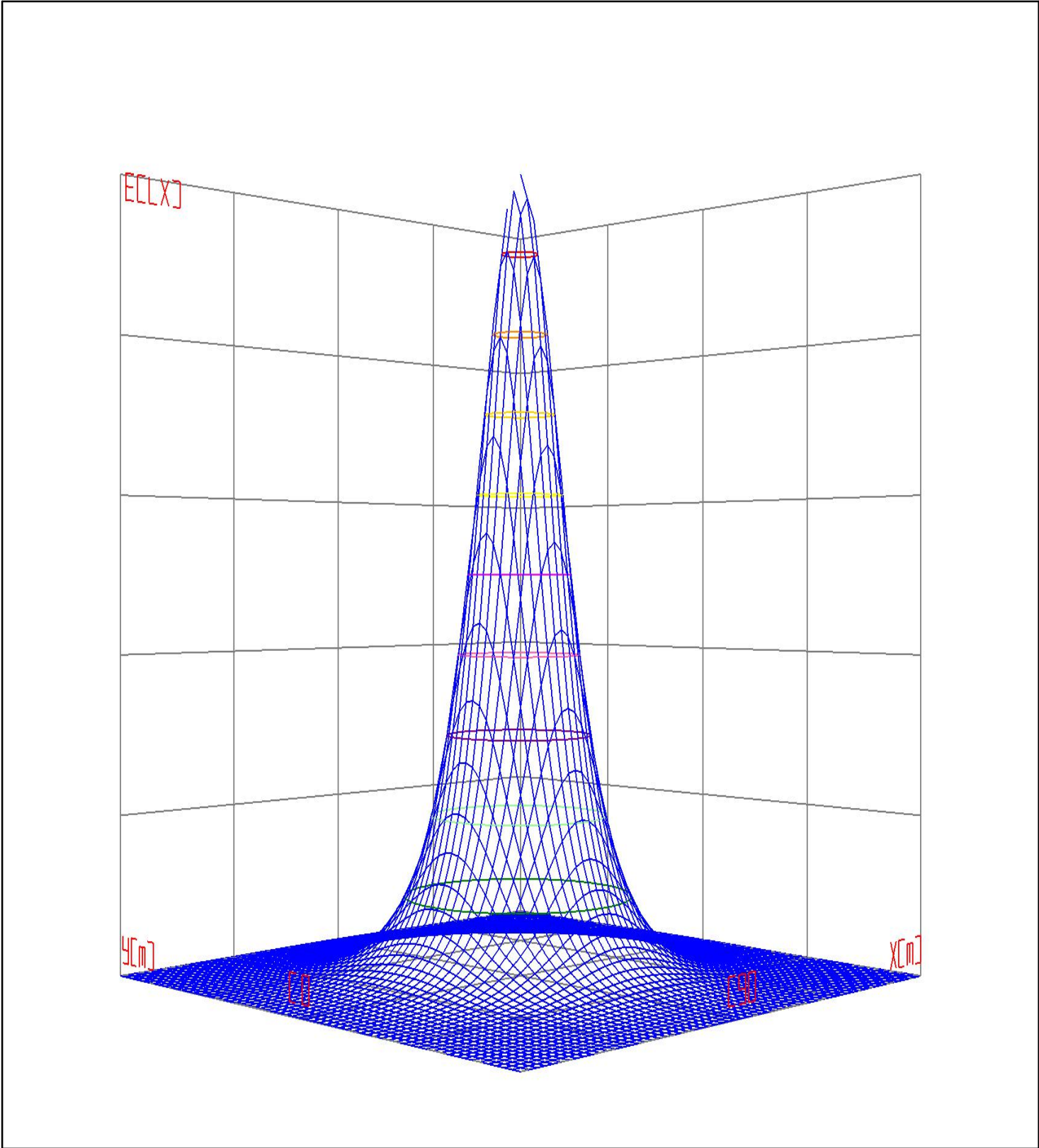

Curves: 3D Model — 90% — 80% — 70% — 60% — 50% — 40% — 30% — 20% — 10%
View Angles(deg): 0 Height(m): 3.0 Distance(m): 10.0

IES Indoor Report

Photometric Filename: TT-2216-L1500-2700K-3-Milky LENS.IES

Space ISO Illuminance Curve

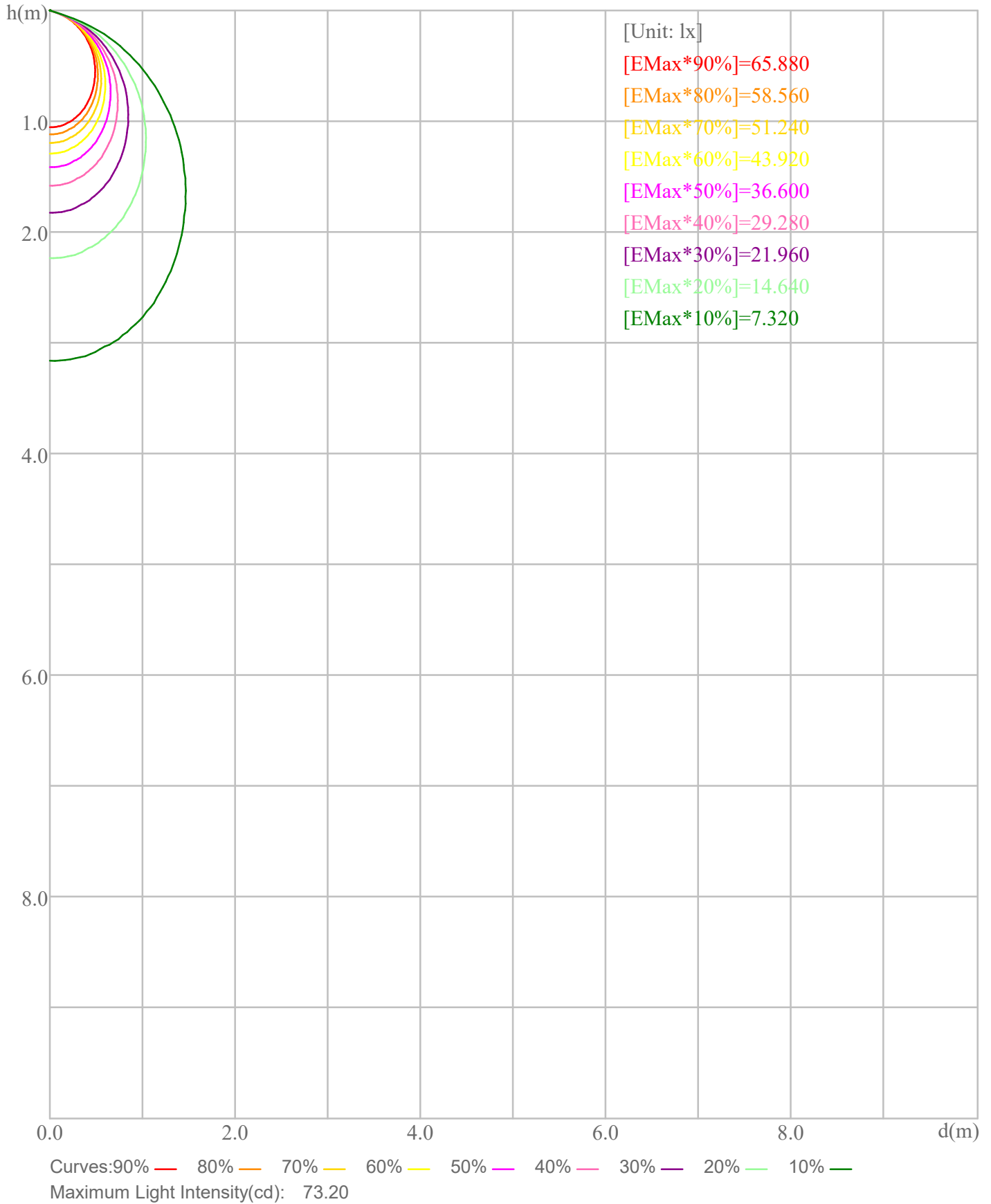

Illuminance-Distance Curve

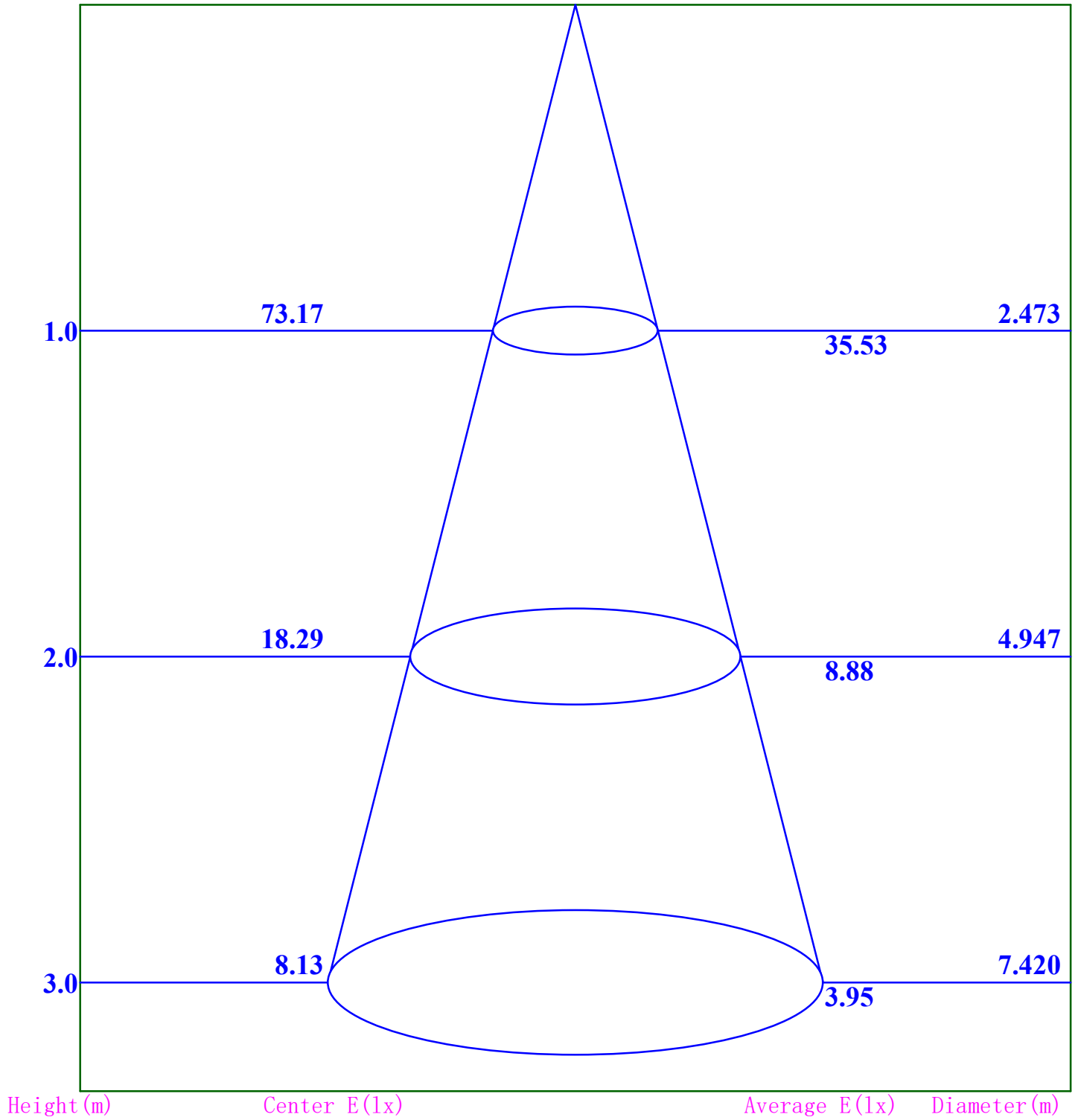

Beam Angle:102.1

IES Indoor Report

Photometric Filename:TT-2216-L1500-2700K-3-Milky LENS.IES

Indoor Luminance Limiting Curve

Glare Grade Table

GI	Quality	Using Illuminance							
		a	b	c	d	e	f	g	h
1.15	A	2000	1000	500	<=300				
1.5	B		2000	1000	500	<=300			
1.85	C			2000	1000	500	<=300		
2.2	D				2000	1000	500	<=300	
2.55	E					2000	1000	500	<=300
		a	b	c	d	e	f	g	h

Luminance Table

Gama(deg)	45	50	55	60	65	70	75	80	85
C0	1122	1070	968	840	681	442	29	0	0
C90	1086	1009	918	793	620	358	0	0	0

Luminance Limiting Curve

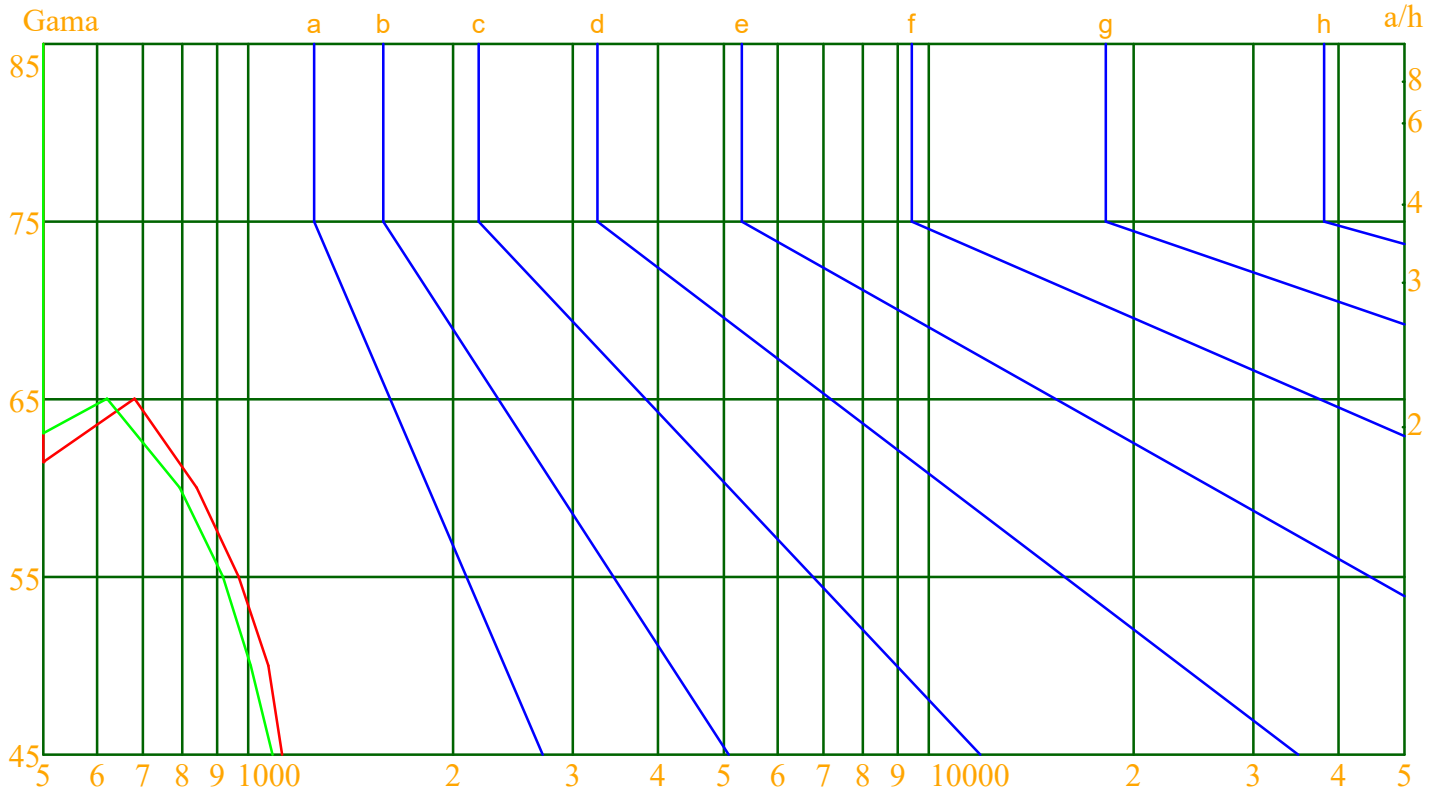

Luminous Size: Length(m)=0.304 Width(m)=0.120 Height(m)=0.060 Area(m²)=0.054720
 Luminous Type: Without Luminous Side
 Luminous Curves: C0-C180 Color: — C90-C270 Color: —

Indoor Budgetary Estimate Table

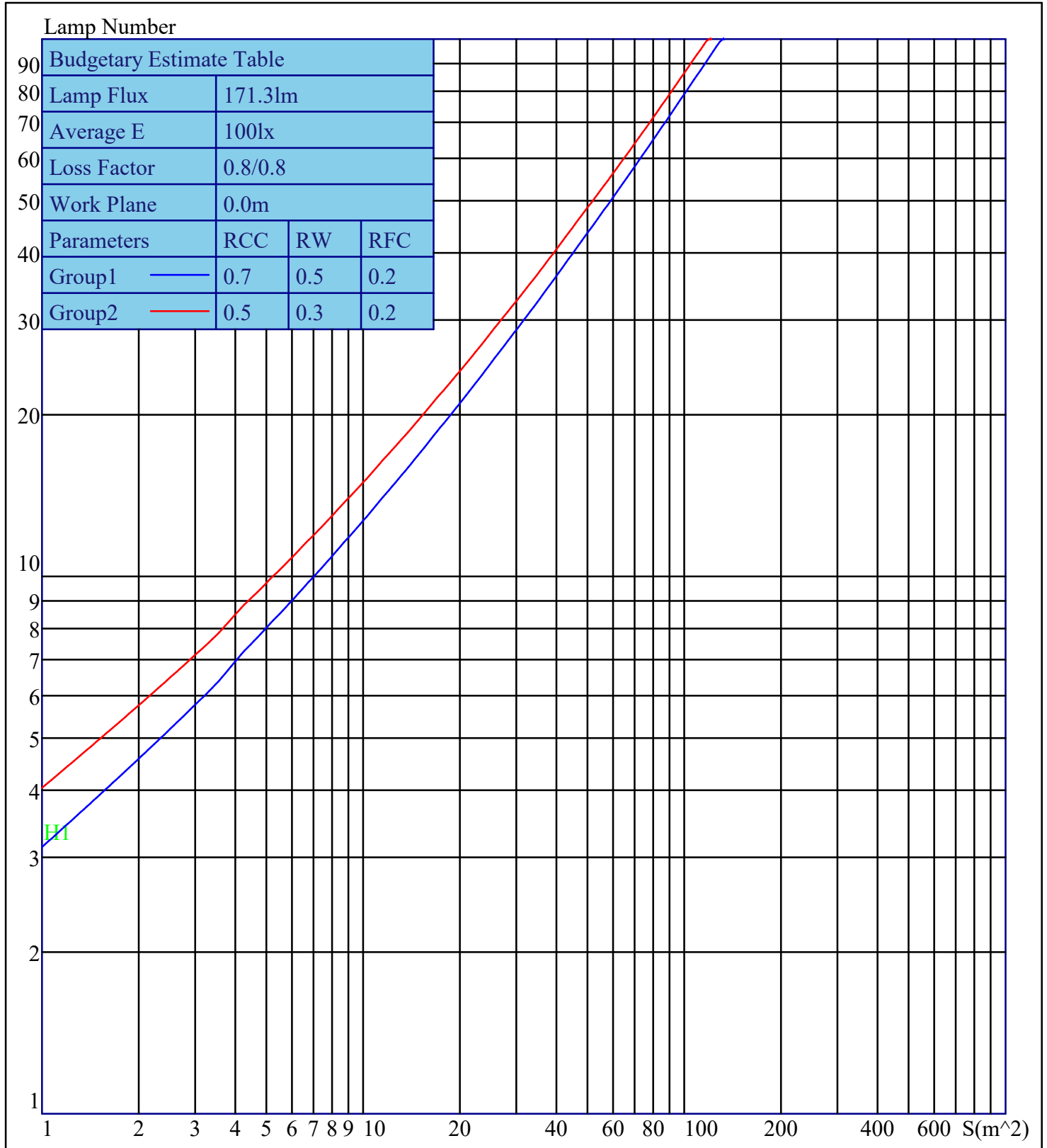

Parameters1: Rhocc = 0.7 Rhow = 0.5 Rhofc = 0.2 LLF = 0.8
 Parameters2: Rhocc = 0.5 Rhow = 0.3 Rhofc = 0.2 LLF = 0.8
 Average Illuminance(lx): 100 Cavity Height: H1(m) = 2