

# TITANIUM

## TECHNOLOGY

TT-2216-L1500



- Del SMD2216 tape in 5 meter roll.

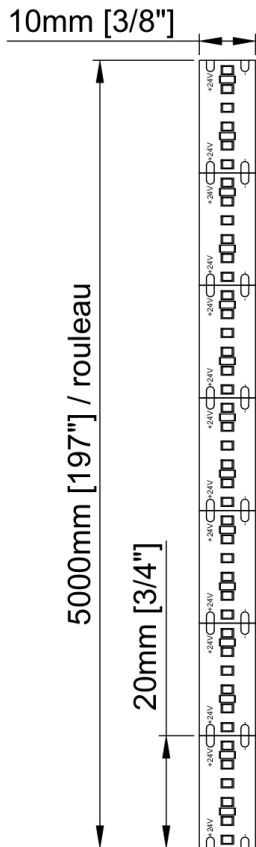

Voltage	24vDC	
LED/m	300 / m	
Power	34,12w / m 10,40w / feet 170,56w / roll	
Amperage	1,34 / m 0,44 / feet 7,11 / roll	
Lumen	27K - 426 lm / feet 30K - 425 lm / feet 35K - 432 lm / feet 40K - 451 lm / feet 60K - 503 lm / feet	51 lm / w 52 lm / w - - 61 lm / w
CRI	90	
Angle	120°	
Size	IP20	10mm x 1,1mm x 5000mm $\frac{3}{8}'' \times \frac{1}{16}'' \times 196\frac{7}{8}''$
	IP65	10mm x 2,5mm x 5000mm $\frac{3}{8}'' \times \frac{1}{8}'' \times 196\frac{7}{8}''$
	IP67	13mm x 5mm x 5000mm $\frac{1}{2}'' \times \frac{3}{16}'' \times 196\frac{7}{8}''$
Cut line	20 mm $\frac{3}{4}''$	
Finish	White	
Dimmable	Yes	
LED Colour	<b>27K</b> - Warm white 2700K <b>30K</b> - Warm white 3000K <b>35K</b> - Neutral white 3500K <b>40K</b> - Neutral white 4000K <b>60K</b> - Cold white 6000K <b>R</b> - Red <b>G</b> - Green <b>B</b> - Blue <b>A</b> - Amber	
Working temp.	-40°C ~ 70°C	
IP	<b>20, 65, 67</b>	

### PRODUCT CODE

TT	SMD	LED PER ROLL	IP	LED COLOR	VOLTAGE
TT	2216	L1500	20	27K	24V
TT	2216	L1500			24V

# IES Indoor Report

Photometric Filename:TT-2216-L1500-2700K-1-NO LENS.IES

## Indoor Luminaire Photometric Data

### Description Information

Luminaire Name: TT-2216-L1500-2700k-1-NO lens	Luminaire Catalog:	Test ID:
Lamp Name: TT-2216-L1500-2700k-1-NO lens	Lamp Catalog: 2216	Test Date: 2021/03/17
Manufacture: TITANIUM TECHNOLOGIE	ShieldingAngle(°):	Test Machine: GON-2000
Test Lab:	Frequency(Hz):	Luminaire CCT(K):
Luminaire Size(W*L*H): 0.120*0.304*0.060	Lighting Area(m2): 0.055	Luminaire Weight(kg): 0.100
Test System: C, $\gamma$	Test Step: C=45.0 $\gamma$ =1.0	Temperature(°C): 25
		Humidity(%):

### Character Parameter

Lamp Speciality Parameter	
Lamp Rated Lumens(lm): 448.000	Lamp Number in Luminaire: 1
Lamp Norminal Power(W):	Lamp Rated Voltage(V):
Lamp Tested Power(W): 8.400	Lamp Tested Voltage(V): 24.5
Lamp Tested Current(A): 0.342	Lamp Tested PF:
Lamp Size(W*L*H): 0.120*0.304*0.060	
Luminaire Speciality	
Luminaire Lumens(lm): 426.233	Beam Angle(10%Imax): 109.3
Luminaire Efficiency: 95.14%	Left=-53.1 Right=56.2
Luminaire EER(lm/W): 50.742	Field Angle(10%Imax): 151.8
Muximum Cand.(cd): 180.171	Spacing Criteria S/MH(C0_180): 1.282
Max Cd. Angle(°): C=270.0 $\gamma$ =3.0	Spacing Criteria S/MH(C90_270): 1.254
Downward Lumens(lm): 426.233	CIE Type: Semi-Direct
Upward Lumens(lm): 0.000	ErP $\phi$ use(120deg): 389.505lm
Downward Total Efficiency%: 100.00	IRF(%): 107.380
Upward Total Efficiency%: 0.00	

# IES Indoor Report

Photometric Filename: TT-2216-L1500-2700K-1-NO LENS.IES

## 2D Light Intensity Distribution Curve

Plane [50%Ang.] [10%Ang.]

C270.0: 109.3 151.8

C0.0: 107.8 114.2

C90.0: 109.3 151.8

Polar Graph

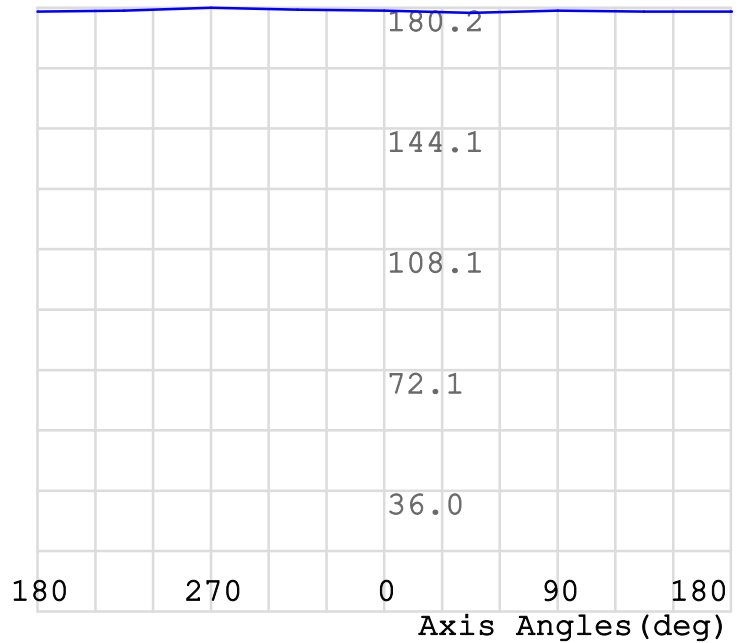
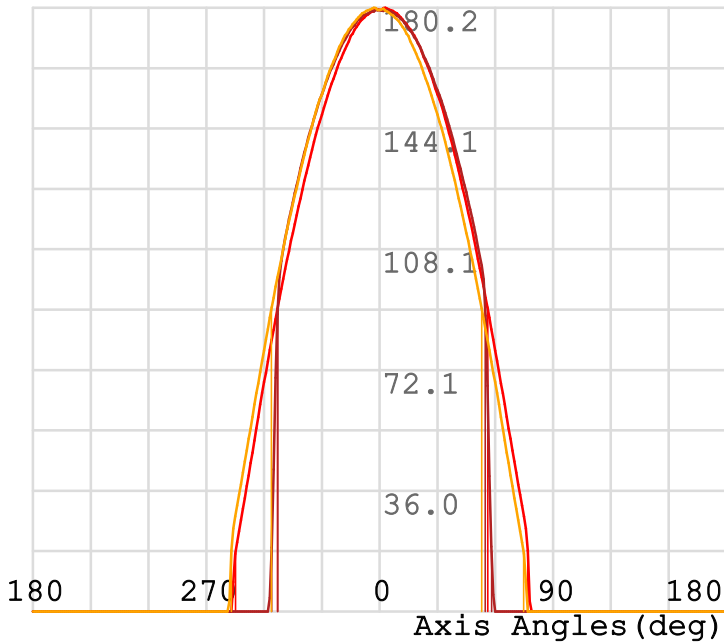
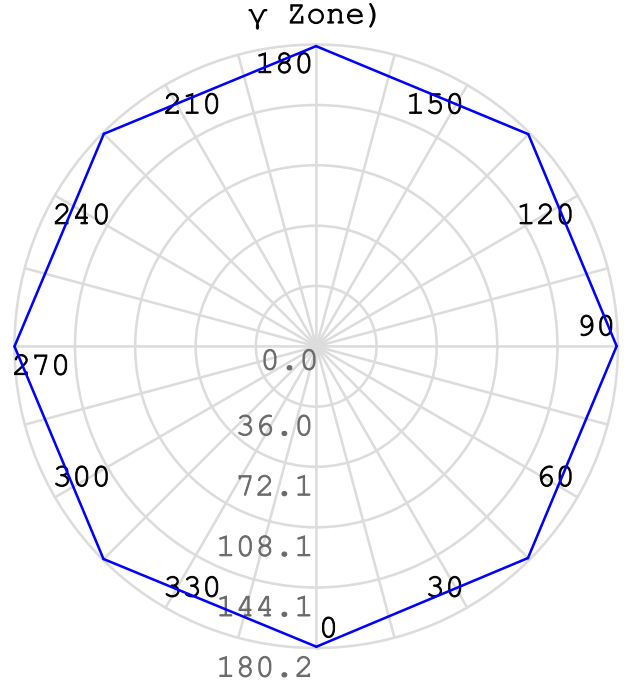
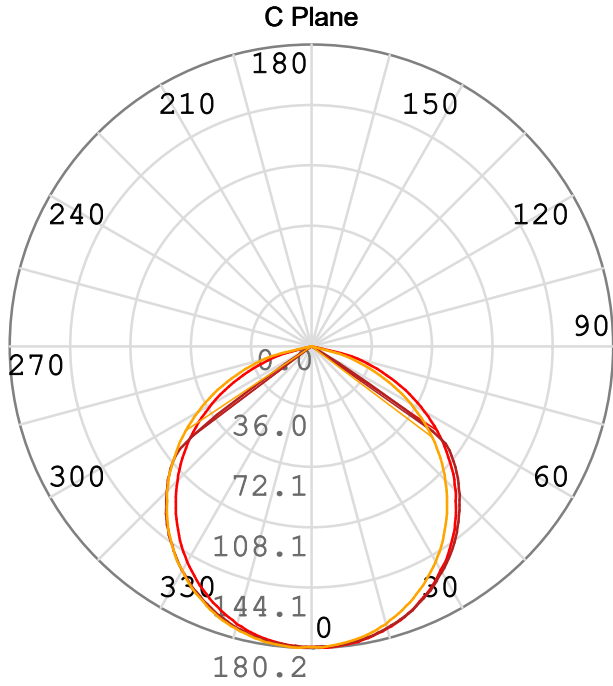

C Plane: C270.0\_90.0 ——— C0.0\_180.0 ——— C90.0\_270.0 ———  
 γ Cone: γ3.0 ———

# IES Indoor Report

Photometric Filename: TT-2216-L1500-2700K-1-NO LENS.IES

## 3D Light Intensity Distribution Curve

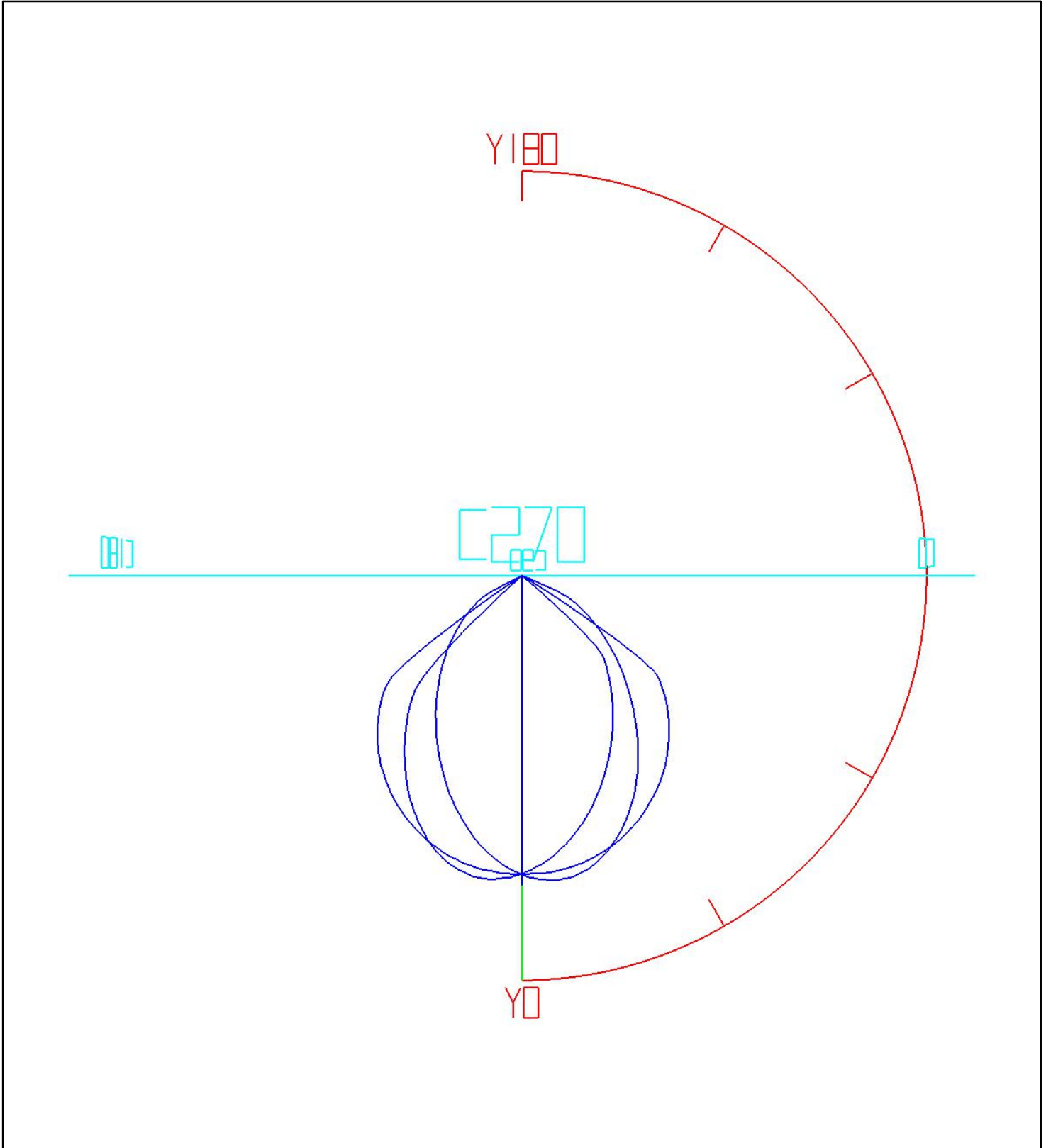

Curves: 3D Model ——— Fixture ——— Vert. HUD ——— Hori. HUD ———  
View Angles: Orient:0 Tilt:0 Roll:0 Spin:0

# IES Indoor Report

Photometric Filename: TT-2216-L1500-2700K-1-NO LENS.IES

## Rectangle ISO Light Intensity Curve

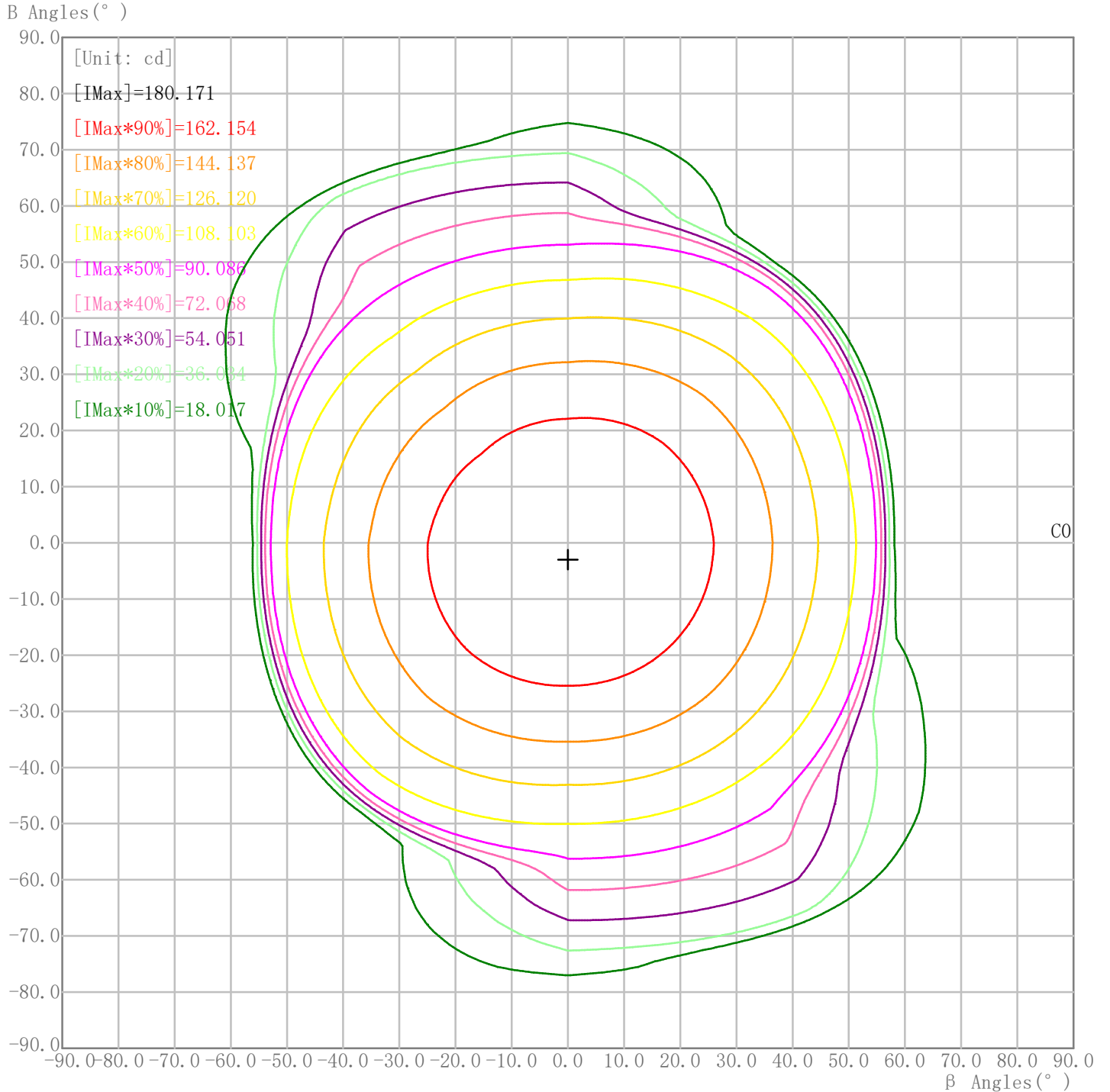

Curves: 90% — 80% — 70% — 60% — 50% — 40% — 30% — 20% — 10% —

Maximum Light Intensity(cd): 180.17      Maximum Cd. Angles: H-0.0 V-3.0

# IES Indoor Report

Photometric Filename: TT-2216-L1500-2700K-1-NO LENS.IES

## Plane ISO-Illuminance Curve

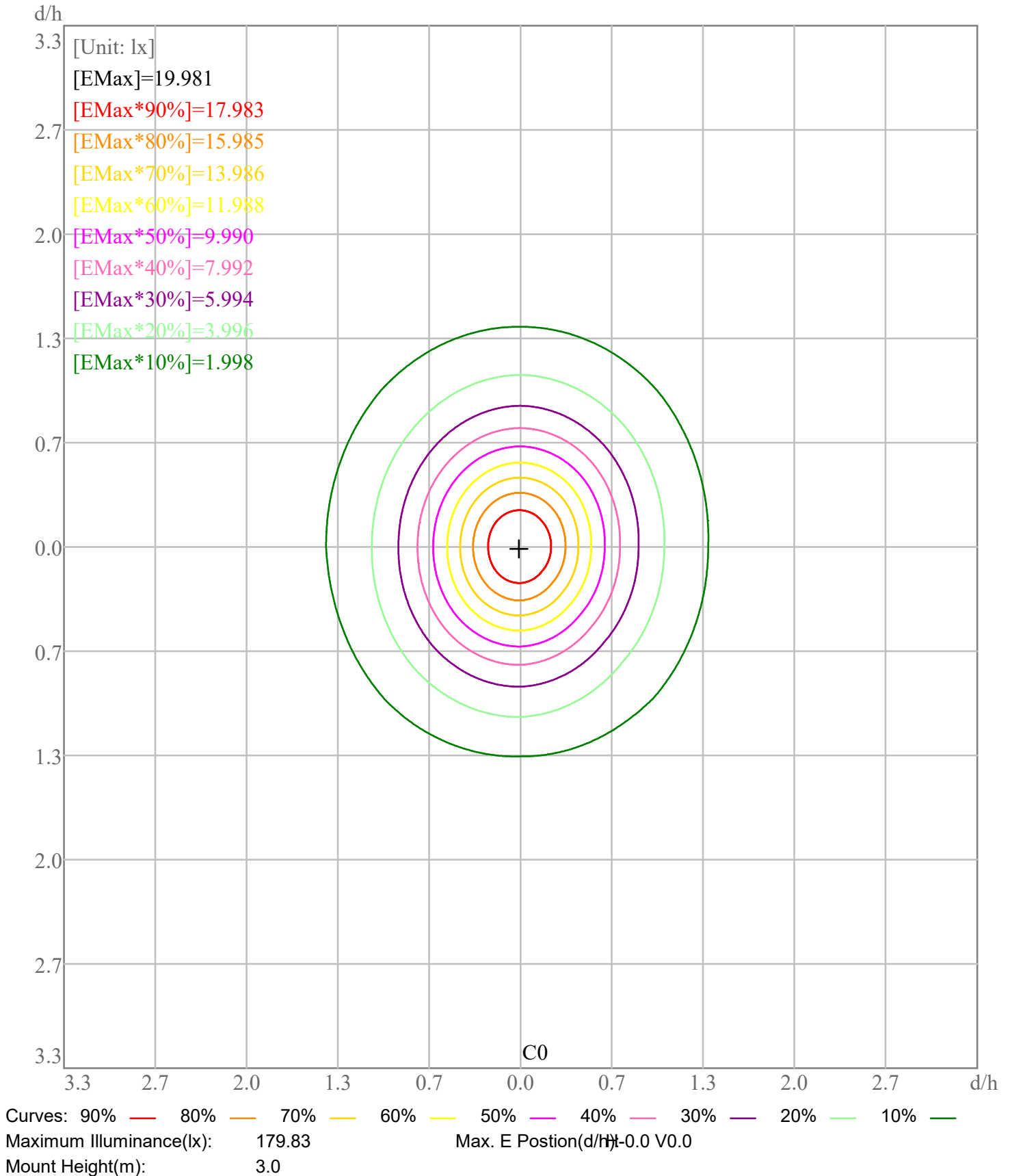

3D Plane ISO Illuminance Curve

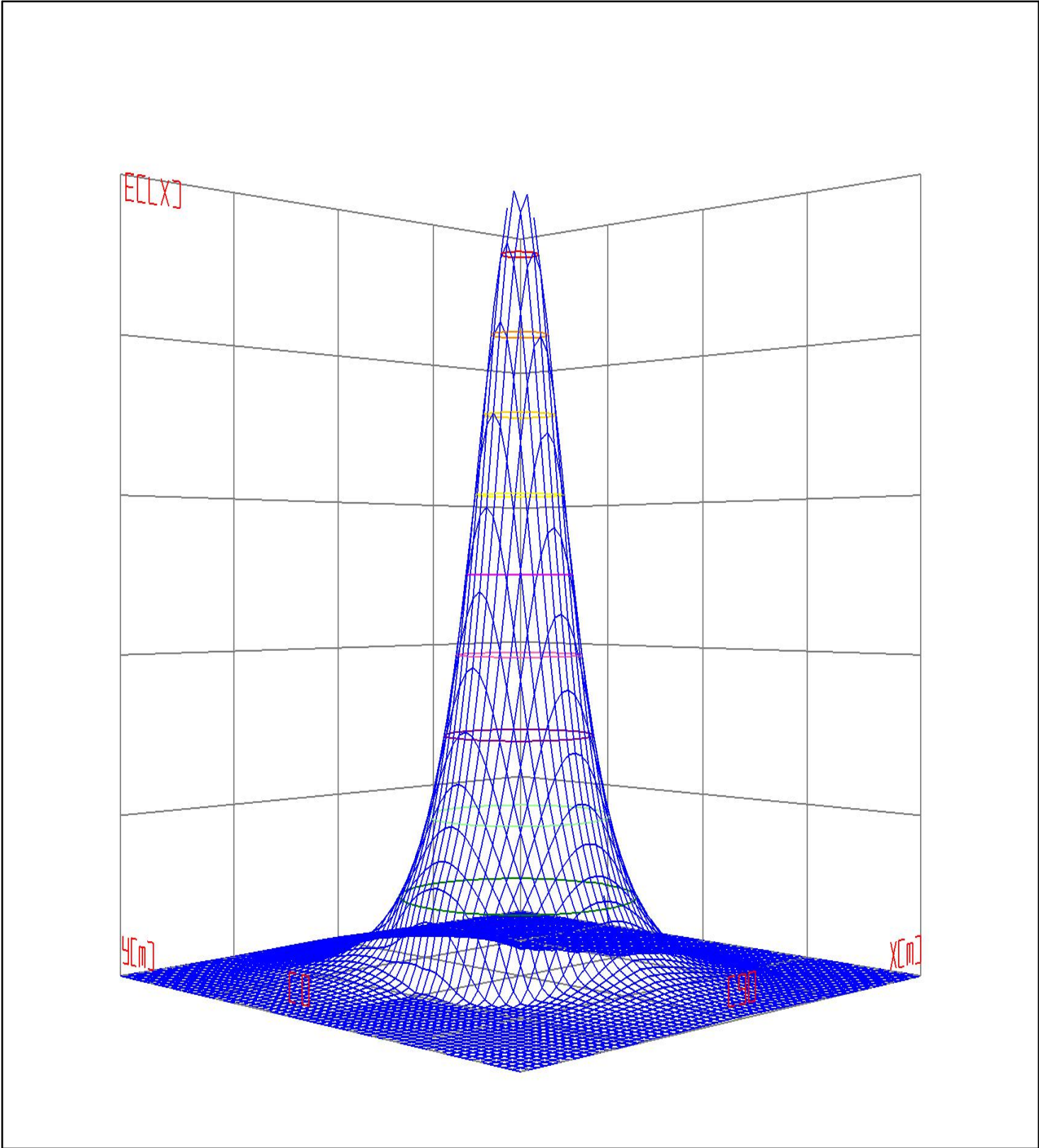

Curves: 3D Model — 90% — 80% — 70% — 60% — 50% — 40% — 30% — 20% — 10%  
View Angles(deg): 0    Height(m): 3.0    Distance(m): 10.0

# IES Indoor Report

Photometric Filename: TT-2216-L1500-2700K-1-NO LENS.IES

## Space ISO Illuminance Curve

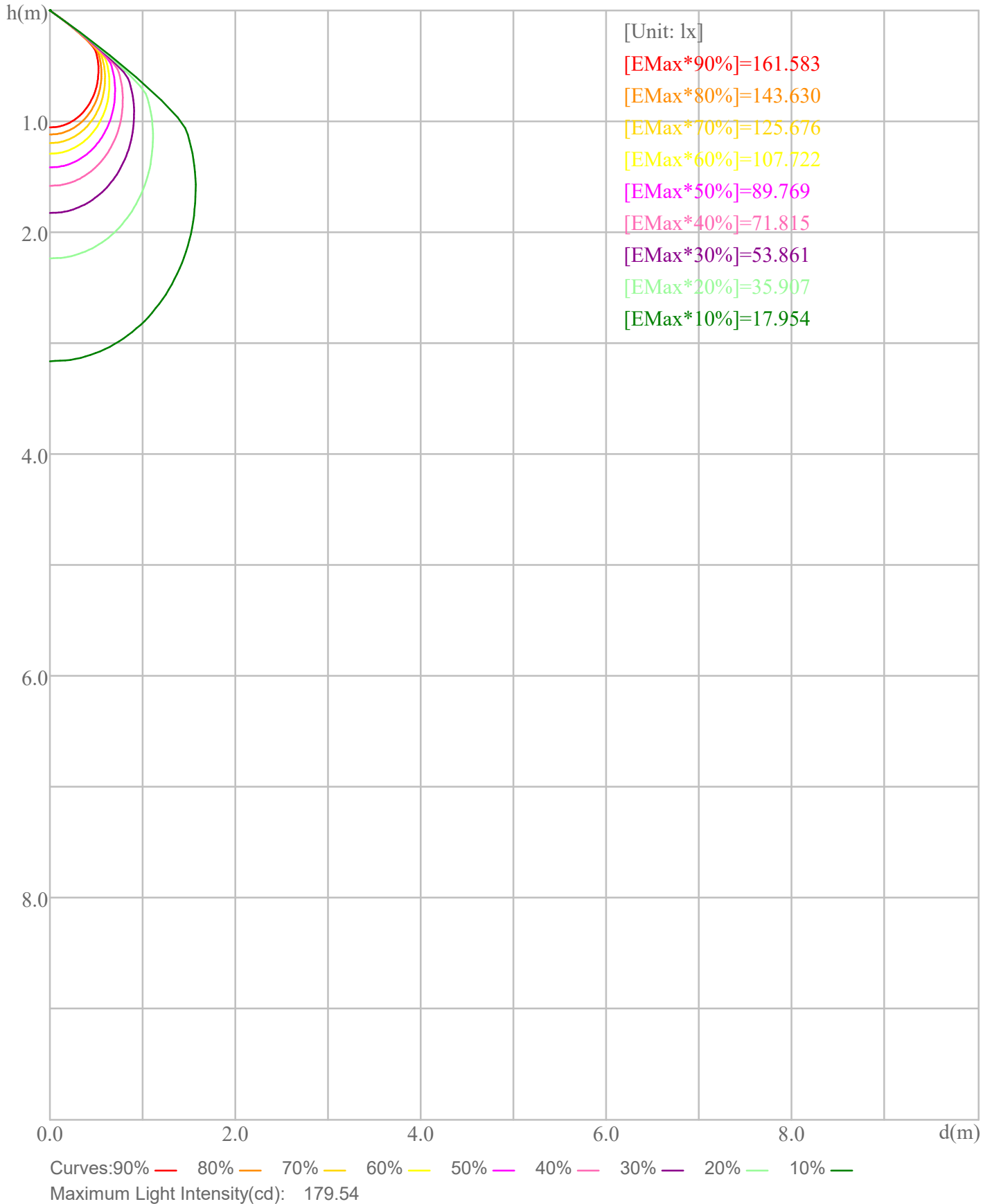



Illuminance-Distance Curve

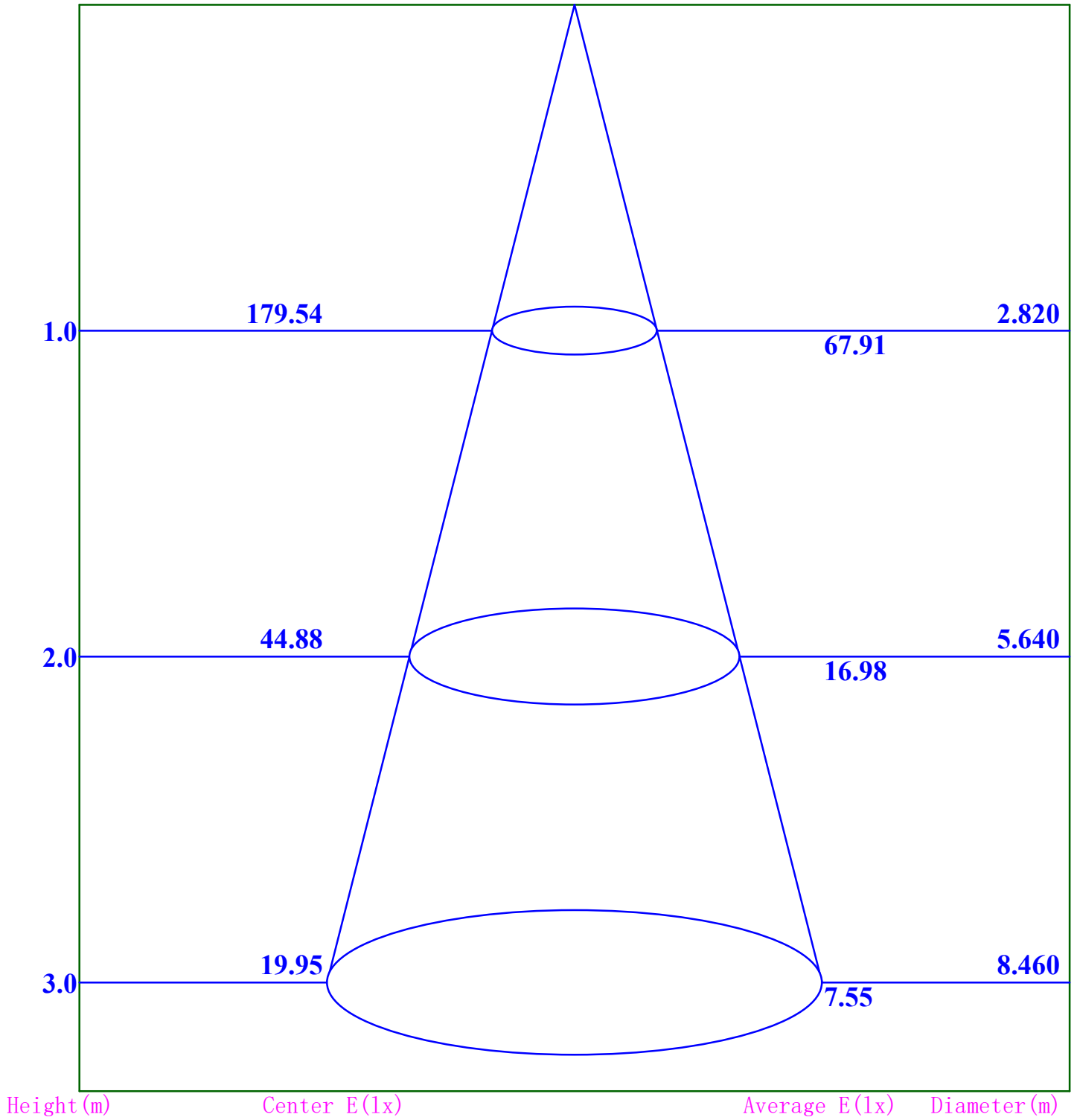

**Beam Angle:109.3**

# IES Indoor Report

Photometric Filename:TT-2216-L1500-2700K-1-NO LENS.IES

## Indoor Luminance Limiting Curve

Glare Grade Table

GI	Quality	Using Illuminance							
		a	b	c	d	e	f	g	h
1.15	A	2000	1000	500	<=300				
1.5	B		2000	1000	500	<=300			
1.85	C			2000	1000	500	<=300		
2.2	D				2000	1000	500	<=300	
2.55	E					2000	1000	500	<=300
		a	b	c	d	e	f	g	h

Luminance Table

Gama(deg)	45	50	55	60	65	70	75	80	85
C0	3235	3186	2813	0	0	0	0	0	0
C90	2918	2821	2678	2503	2206	1809	1217	0	0

Luminance Limiting Curve

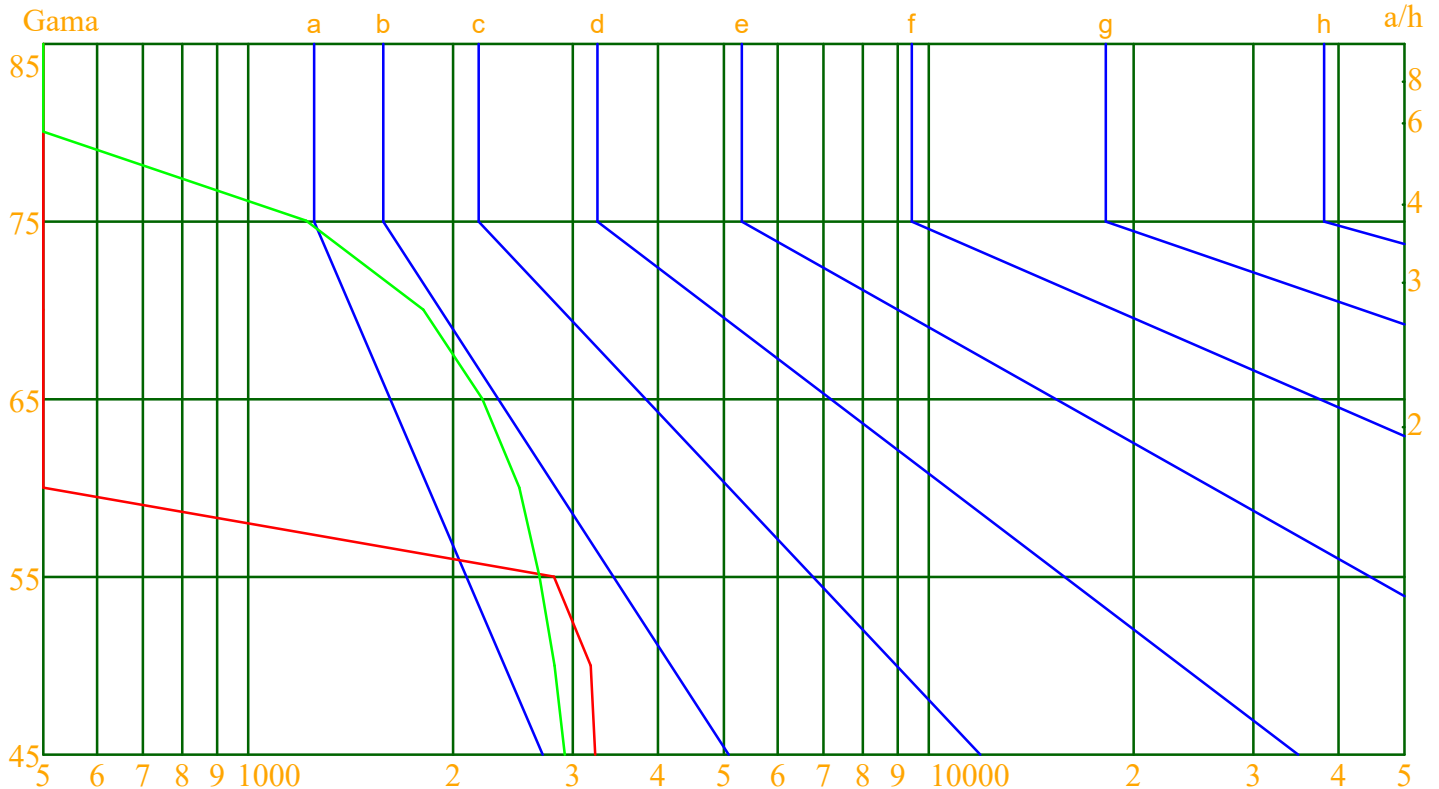

Luminous Size: Length(m)=0.304    Width(m)=0.120    Height(m)=0.060    Area(m<sup>2</sup>)=0.054720  
 Luminous Type: Without Luminous Side  
 Luminous Curves: C0-C180 Color: —    C90-C270 Color: —

Indoor Budgetary Estimate Table

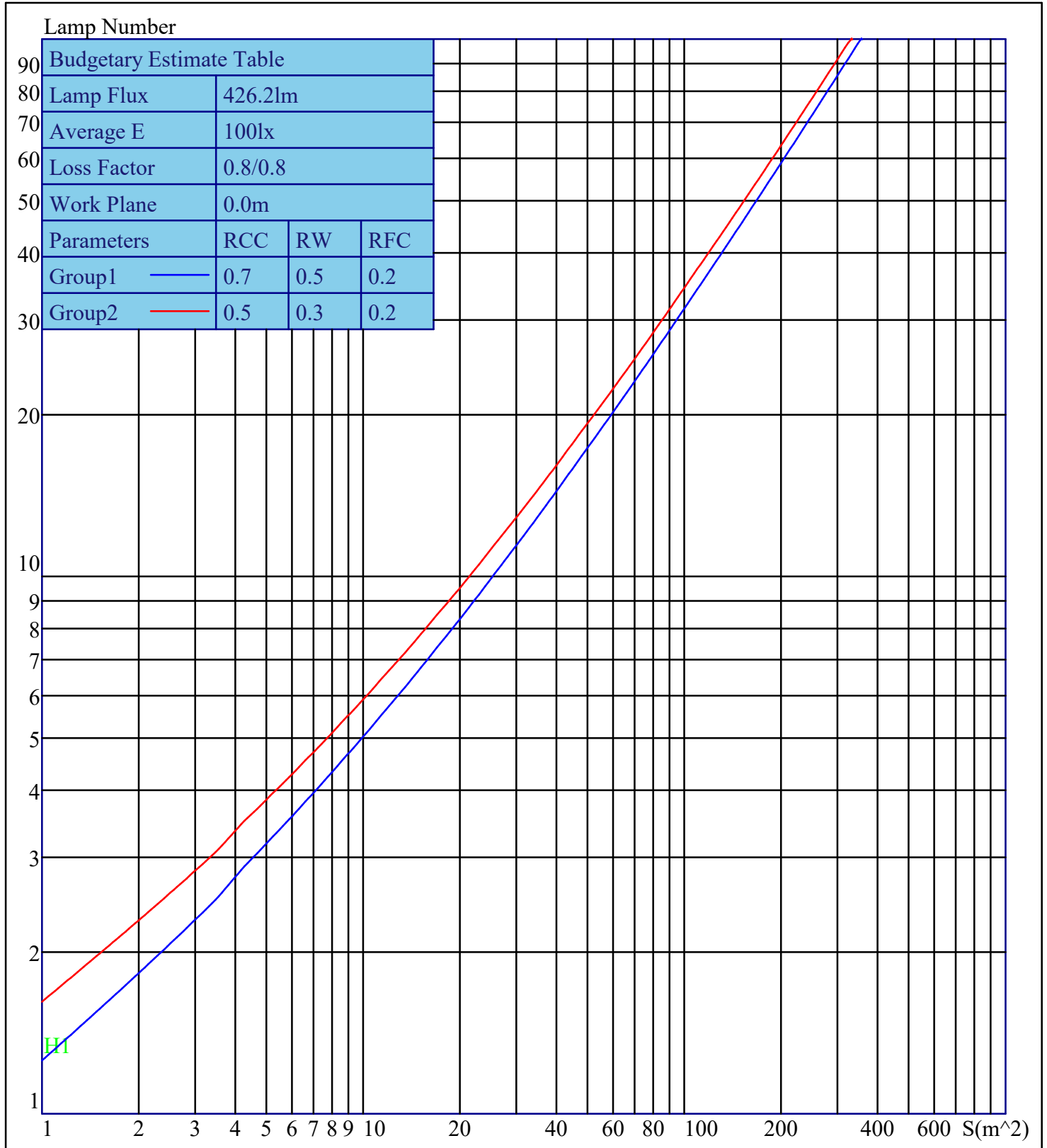

Parameters1: Rhocc = 0.7 Rhow = 0.5 Rhofc = 0.2 LLF = 0.8  
 Parameters2: Rhocc = 0.5 Rhow = 0.3 Rhofc = 0.2 LLF = 0.8  
 Average Illuminance(lx): 100 Cavity Height: H1(m) = 2