

TITANIUM

TECHNOLOGY

TT-2216-L1500



- Del SMD2216 tape in 5 meter roll.

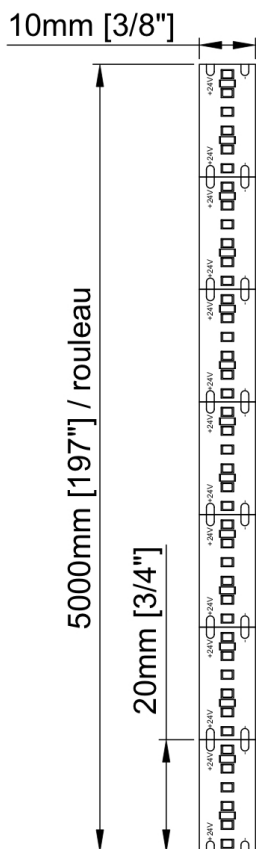

Voltage	24vDC	
LED/m	300 / m	
Power	34,12w / m 10,40w / feet 170,56w / roll	
Amperage	1,34 / m 0,44 / feet 7,11 / roll	
Lumen	27K - 426 lm / feet 30K - 425 lm / feet 35K - 432 lm / feet 40K - 451 lm / feet 60K - 503 lm / feet	51 lm / w 52 lm / w - - 61 lm / w
CRI	90	
Angle	120°	
Size	IP20	10mm x 1,1mm x 5000mm $\frac{3}{8}$ " x $\frac{1}{16}$ " x $196\frac{7}{8}$ "
	IP65	10mm x 2,5mm x 5000mm $\frac{3}{8}$ " x $\frac{1}{8}$ " x $196\frac{7}{8}$ "
	IP67	13mm x 5mm x 5000mm $\frac{1}{2}$ " x $\frac{3}{16}$ " x $196\frac{7}{8}$ "
Cut line	20 mm $\frac{3}{4}$ "	
Finish	White	
Dimmable	Yes	
LED Colour	27K - Warm white 2700K 30K - Warm white 3000K 35K - Neutral white 3500K 40K - Neutral white 4000K 60K - Cold white 6000K R - Red G - Green B - Blue A - Amber	
Working temp.	-40°C ~ 70°C	
IP	20, 65, 67	

PRODUCT CODE

TT	SMD	LED PER ROLL	IP	LED COLOR	VOLTAGE
TT	2216	L1500	20	27K	24V
TT	2216	L1500			24V

IES Indoor Report

Photometric Filename:TT-2216-L1500-3000K-5-Smoke LENS.IES

Indoor Luminaire Photometric Data

Description Information

Luminaire Name: TT-2216-L1500-3000k-5-smoke lens	Luminaire Catalog:	Test ID:
Lamp Name: TT-2216-L1500-3000k-5-smoke lens	Lamp Catalog: 2216	Test Date: 2021/03/17
Manufacture: TITANIUM TECHNOLOGIE	ShieldingAngle(°):	Test Machine: GON-2000
Test Lab:	Frequency(Hz):	Luminaire CCT(K):
Luminaire Size(W*L*H): 0.120*0.304*0.060	Lighting Area(m2): 0.055	Luminaire Weight(kg): 0.100
Test System: C, γ	Test Step: C=45.0 γ =1.0	Temperature(°C): 25
		Humidity(%):

Character Parameter

Lamp Speciality Parameter	
Lamp Rated Lumens(lm): 448.000	Lamp Number in Luminaire: 1
Lamp Norminal Power(W):	Lamp Rated Voltage(V):
Lamp Tested Power(W): 8.376	Lamp Tested Voltage(V): 24.5
Lamp Tested Current(A): 0.341	Lamp Tested PF:
Lamp Size(W*L*H): 0.120*0.304*0.060	
Luminaire Speciality	
Luminaire Lumens(lm): 101.407	Beam Angle(10%Imax): 74.5
Luminaire Efficiency: 22.64%	Left=-37.0 Right=37.4
Luminaire EER(lm/W): 12.107	Field Angle(10%Imax): 116.2
Muximum Cand.(cd): 68.436	Spacing Criteria S/MH(C0_180): 1.018
Max Cd. Angle(°): C=180.0 γ =2.0	Spacing Criteria S/MH(C90_270): 1.038
Downward Lumens(lm): 101.407	CIE Type: Semi-Direct
Upward Lumens(lm): 0.000	ErP ϕ use(90deg): 81.220lm
Downward Total Efficiency%: 100.00	IRF(%): 157.421
Upward Total Efficiency%: 0.00	

IES Indoor Report

Photometric Filename: TT-2216-L1500-3000K-5-Smoke LENS.IES

2D Light Intensity Distribution Curve

Plane [50%Ang.] [10%Ang.]

C180.0: 74.5 116.2

C0.0: 74.5 116.2

C90.0: 77.0 120.5

Polar Graph

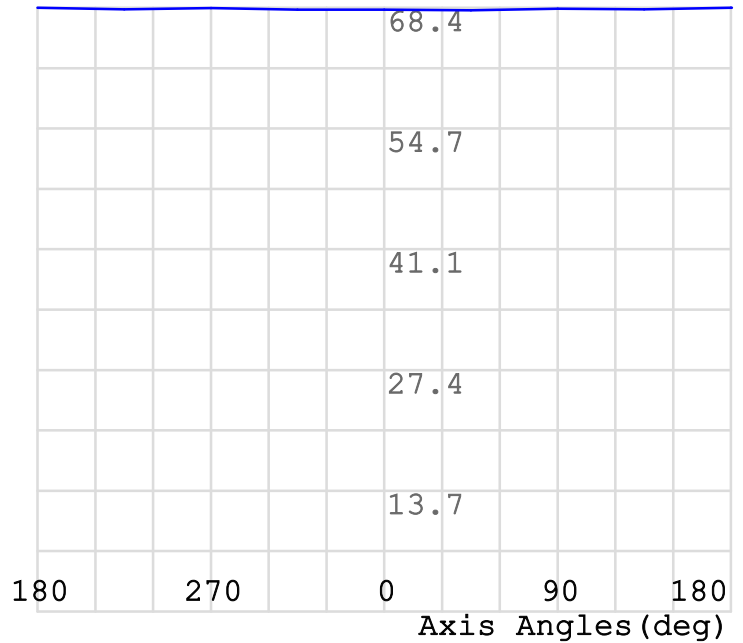
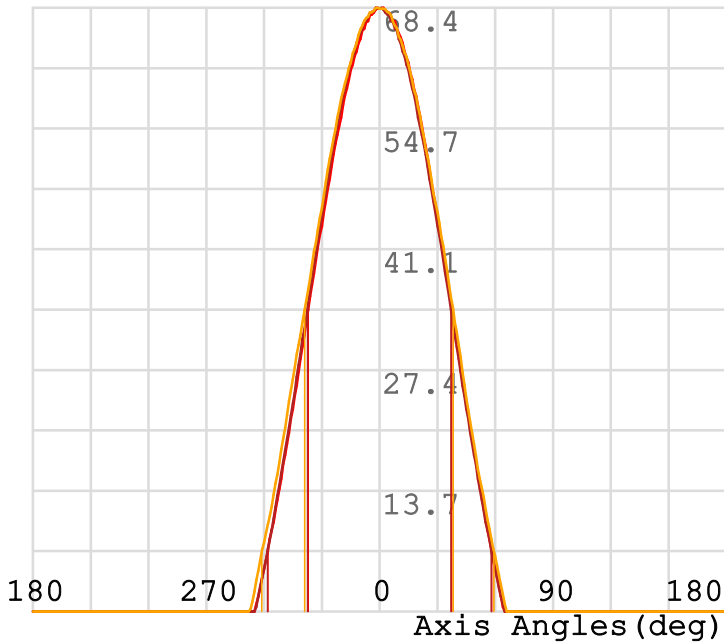
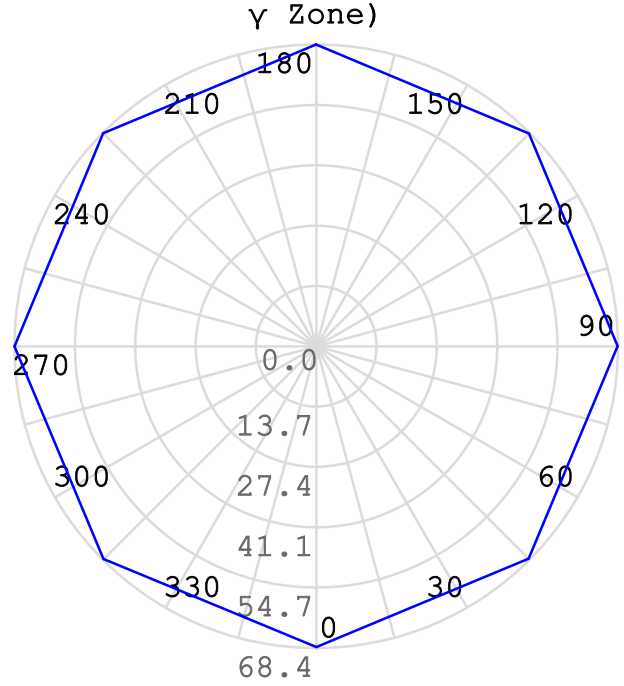
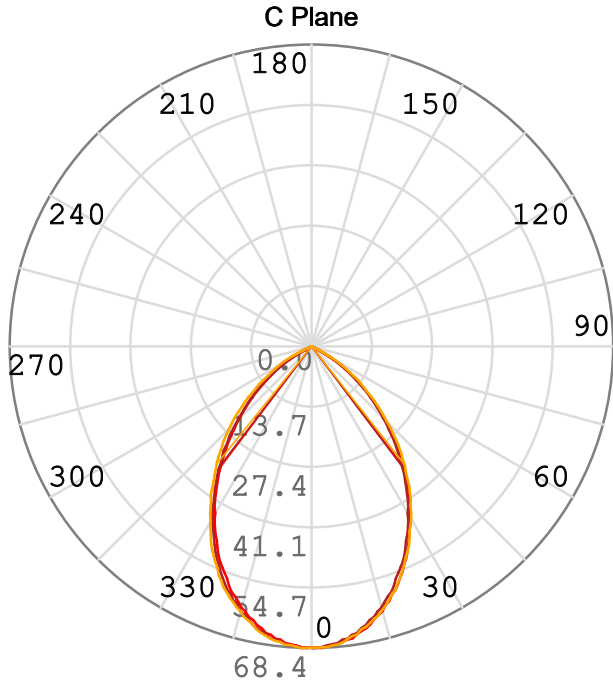

C Plane: C180.0_360.0 ——— C0.0_180.0 ——— C90.0_270.0 ———
 γ Cone: γ2.0 ———

3D Light Intensity Distribution Curve

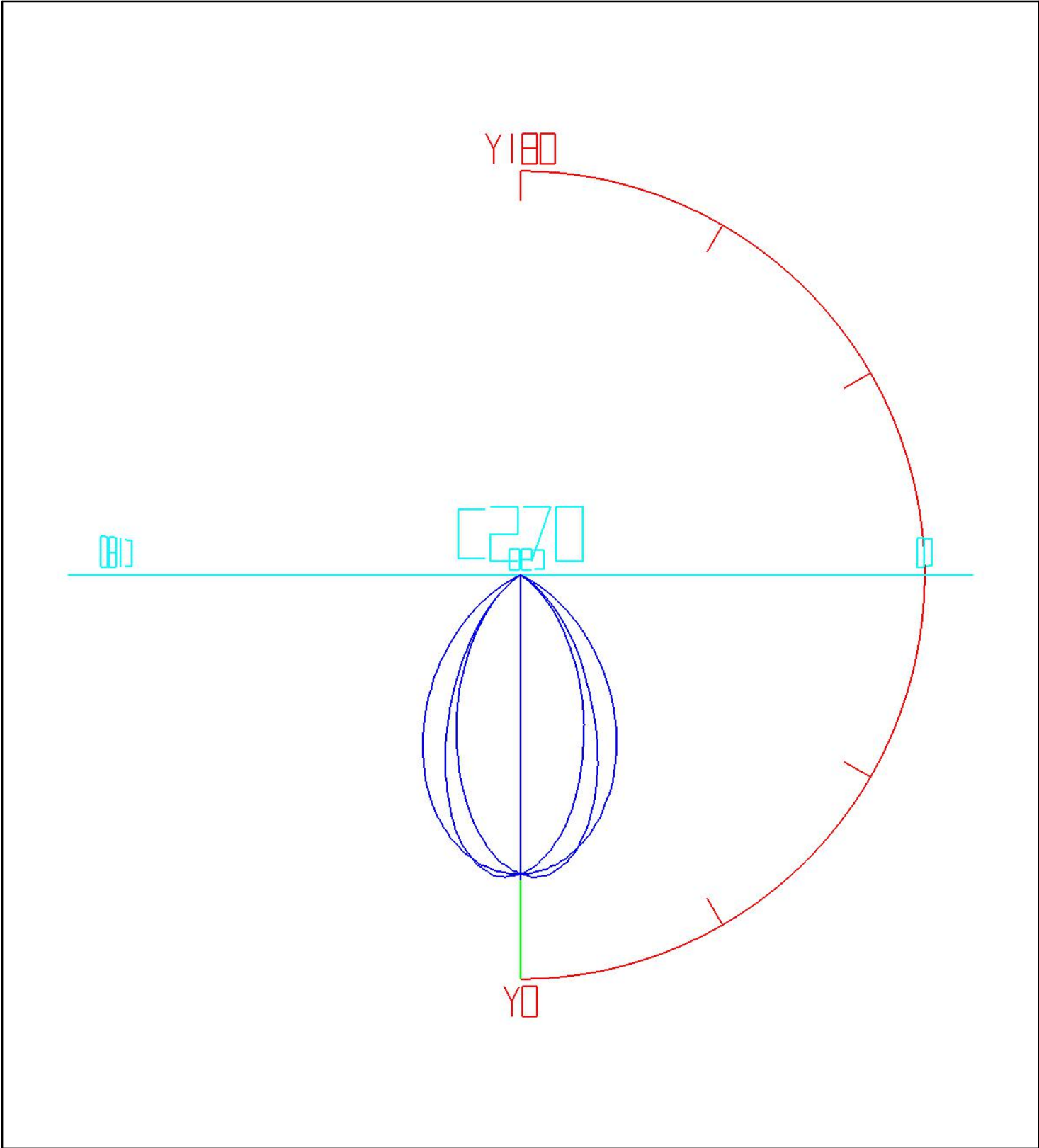

Curves: 3D Model ——— Fixture ——— Vert. HUD ——— Hori. HUD ———
View Angles: Orient:0 Tilt:0 Roll:0 Spin:0

IES Indoor Report

Photometric Filename: TT-2216-L1500-3000K-5-Smoke LENS.IES

Rectangle ISO Light Intensity Curve

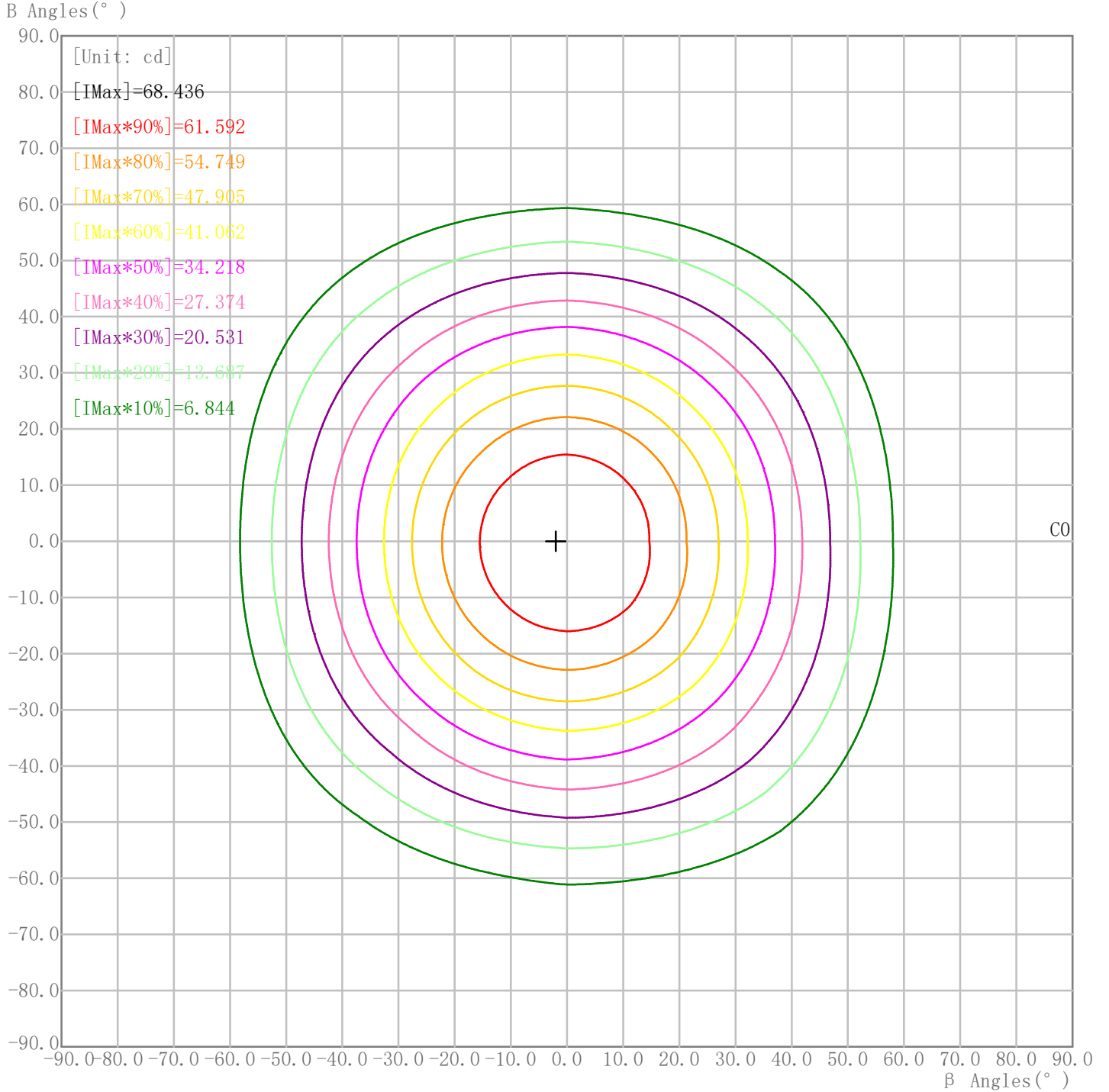

Curves: 90% — 80% — 70% — 60% — 50% — 40% — 30% — 20% — 10% —

Maximum Light Intensity(cd): 68.44 Maximum Cd. Angles: H-2.0 V0.0

IES Indoor Report

Photometric Filename: TT-2216-L1500-3000K-5-Smoke LENS.IES

Plane ISO-Illuminance Curve

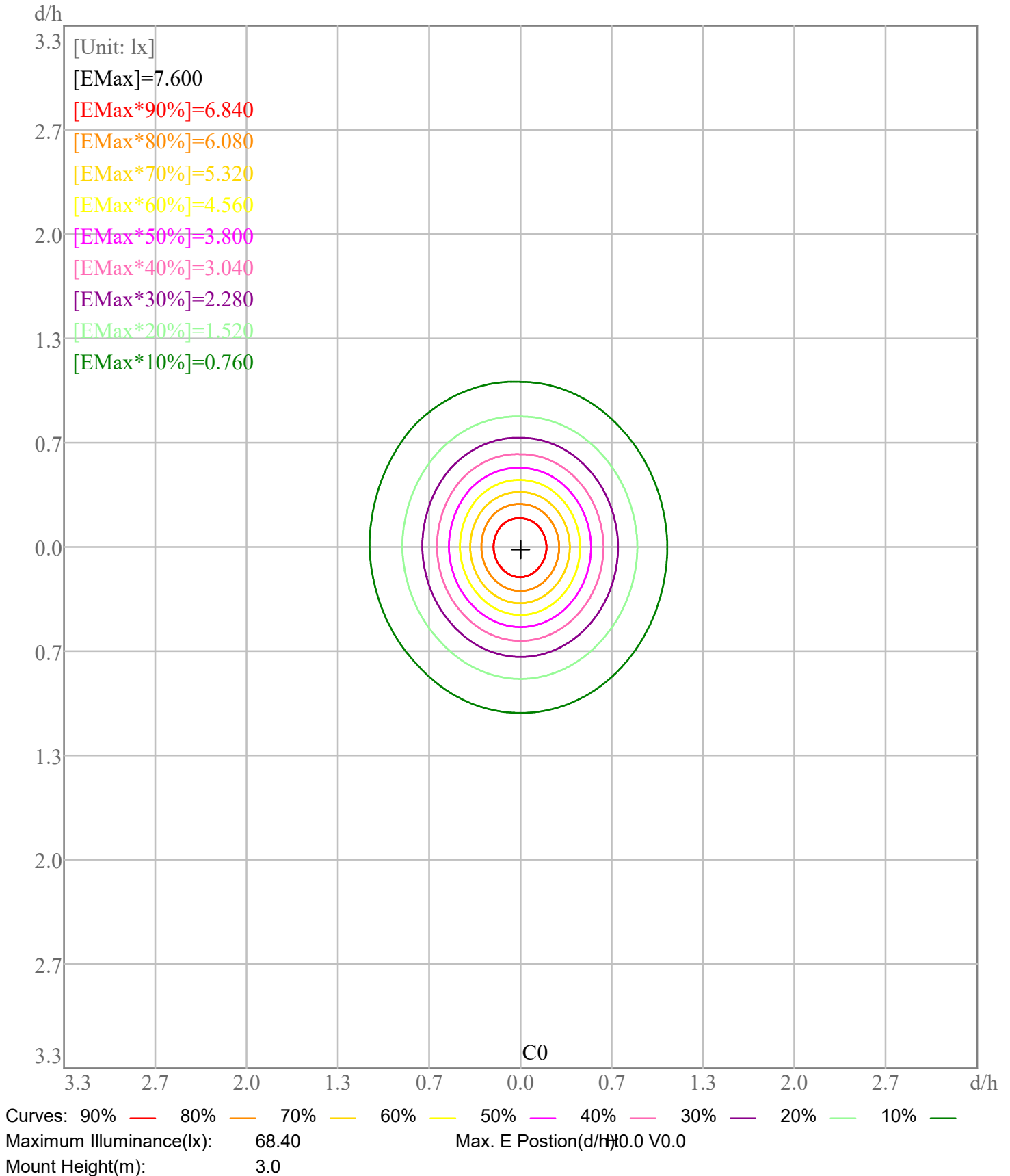

3D Plane ISO Illuminance Curve

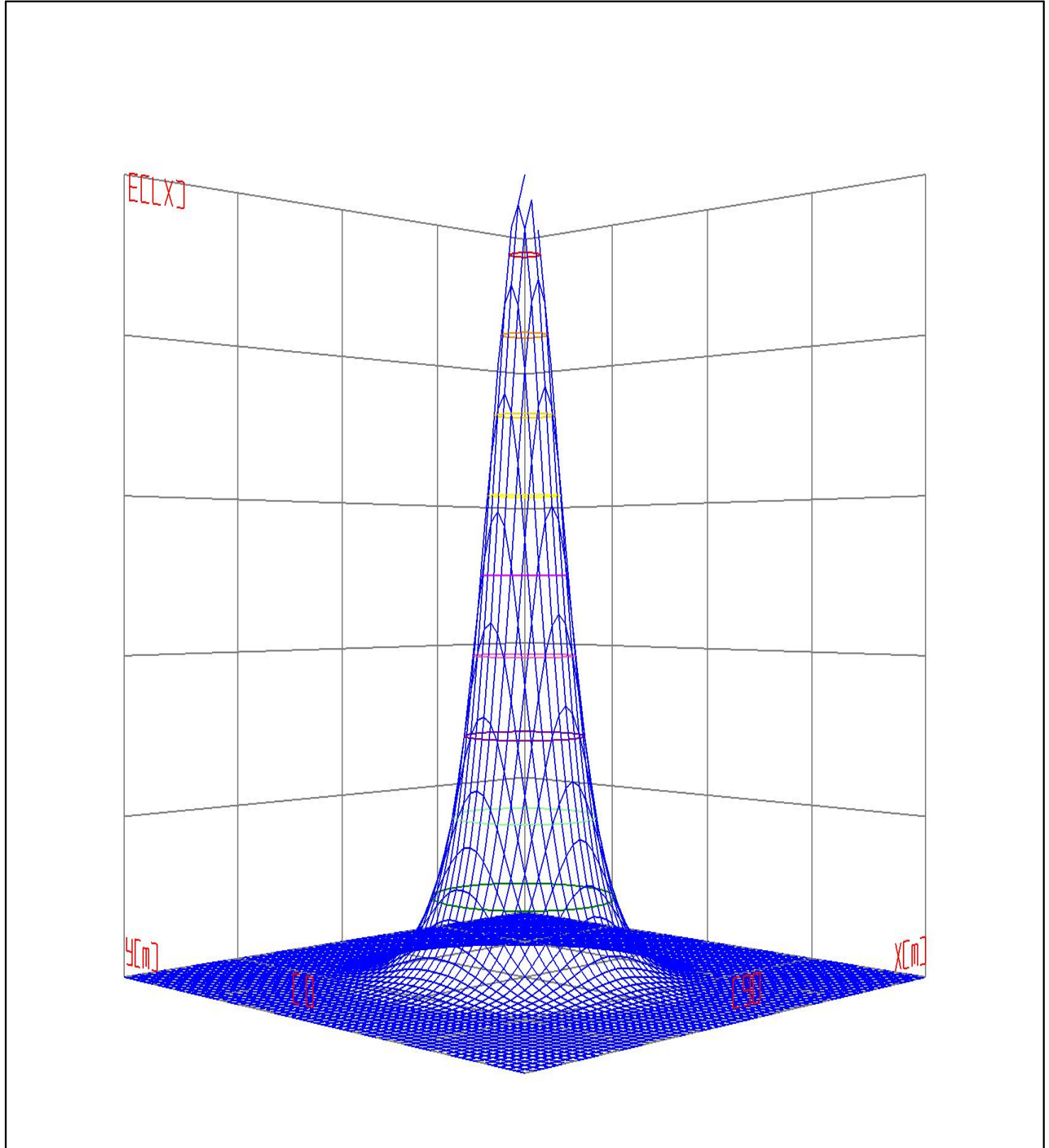

Curves: 3D Model — 90% — 80% — 70% — 60% — 50% — 40% — 30% — 20% — 10%
View Angles(deg): 0 Height(m): 3.0 Distance(m): 10.0

IES Indoor Report

Photometric Filename: TT-2216-L1500-3000K-5-Smoke LENS.IES

Space ISO Illuminance Curve

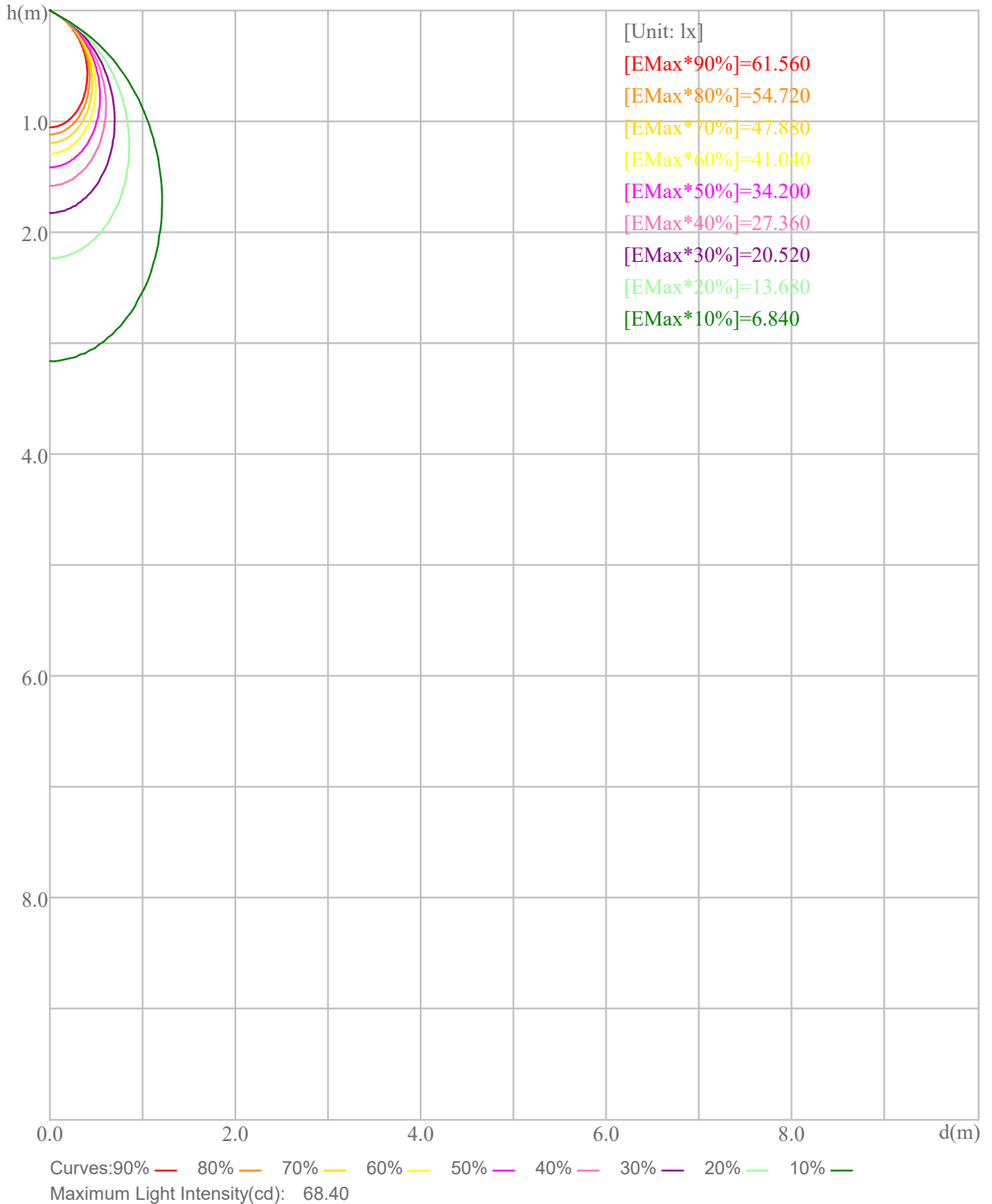

Illuminance-Distance Curve

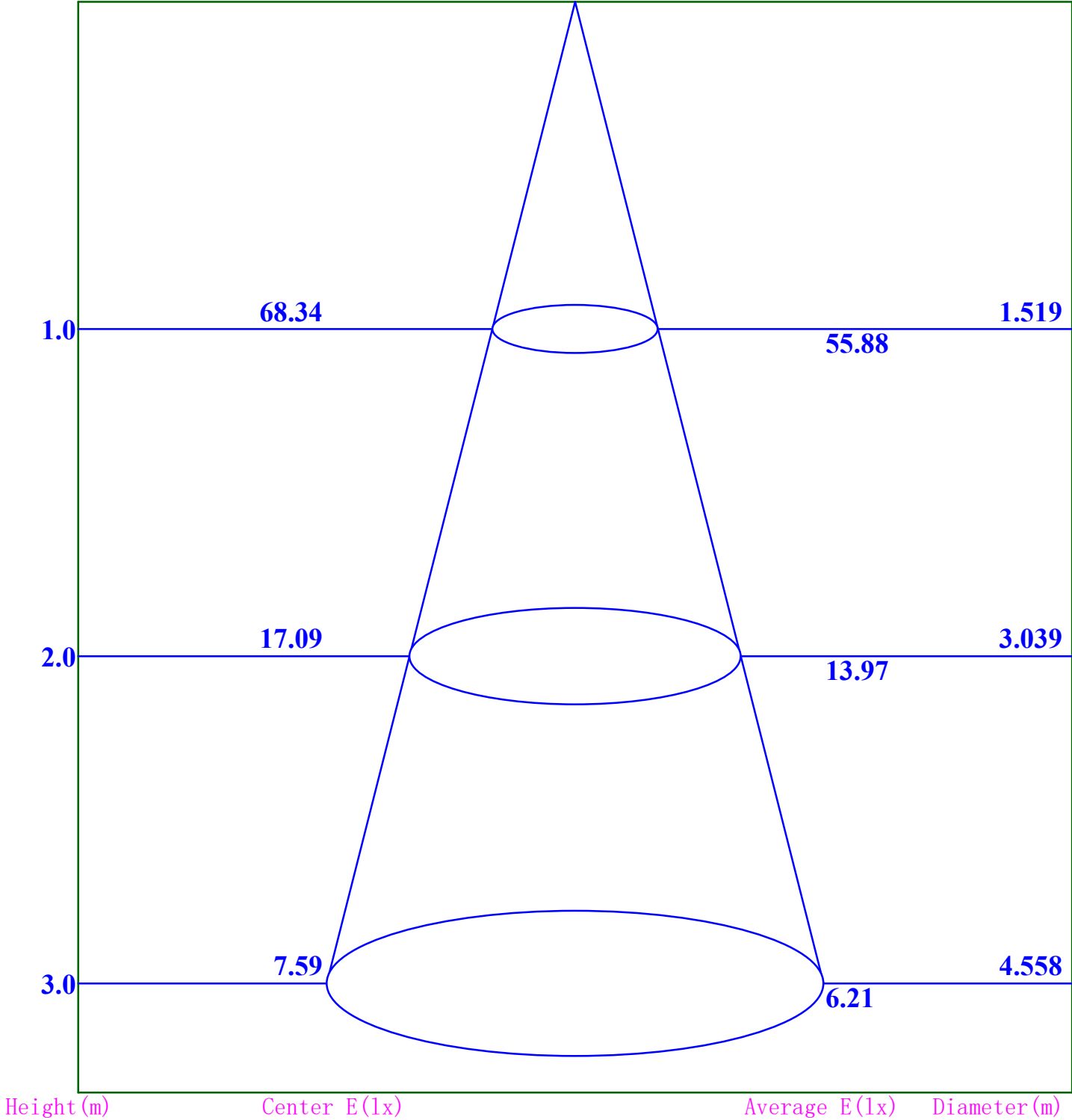

Beam Angle:74.5

IES Indoor Report

Photometric Filename:TT-2216-L1500-3000K-5-Smoke LENS.IES

Indoor Luminance Limiting Curve

Glare Grade Table

GI	Quality	Using Illuminance							
		a	b	c	d	e	f	g	h
1.15	A	2000	1000	500	<=300				
1.5	B		2000	1000	500	<=300			
1.85	C			2000	1000	500	<=300		
2.2	D				2000	1000	500	<=300	
2.55	E					2000	1000	500	<=300
		a	b	c	d	e	f	g	h

Luminance Table

Gama(deg)	45	50	55	60	65	70	75	80	85
C0	593	475	322	175	0	0	0	0	0
C90	625	502	372	229	38	0	0	0	0

Luminance Limiting Curve

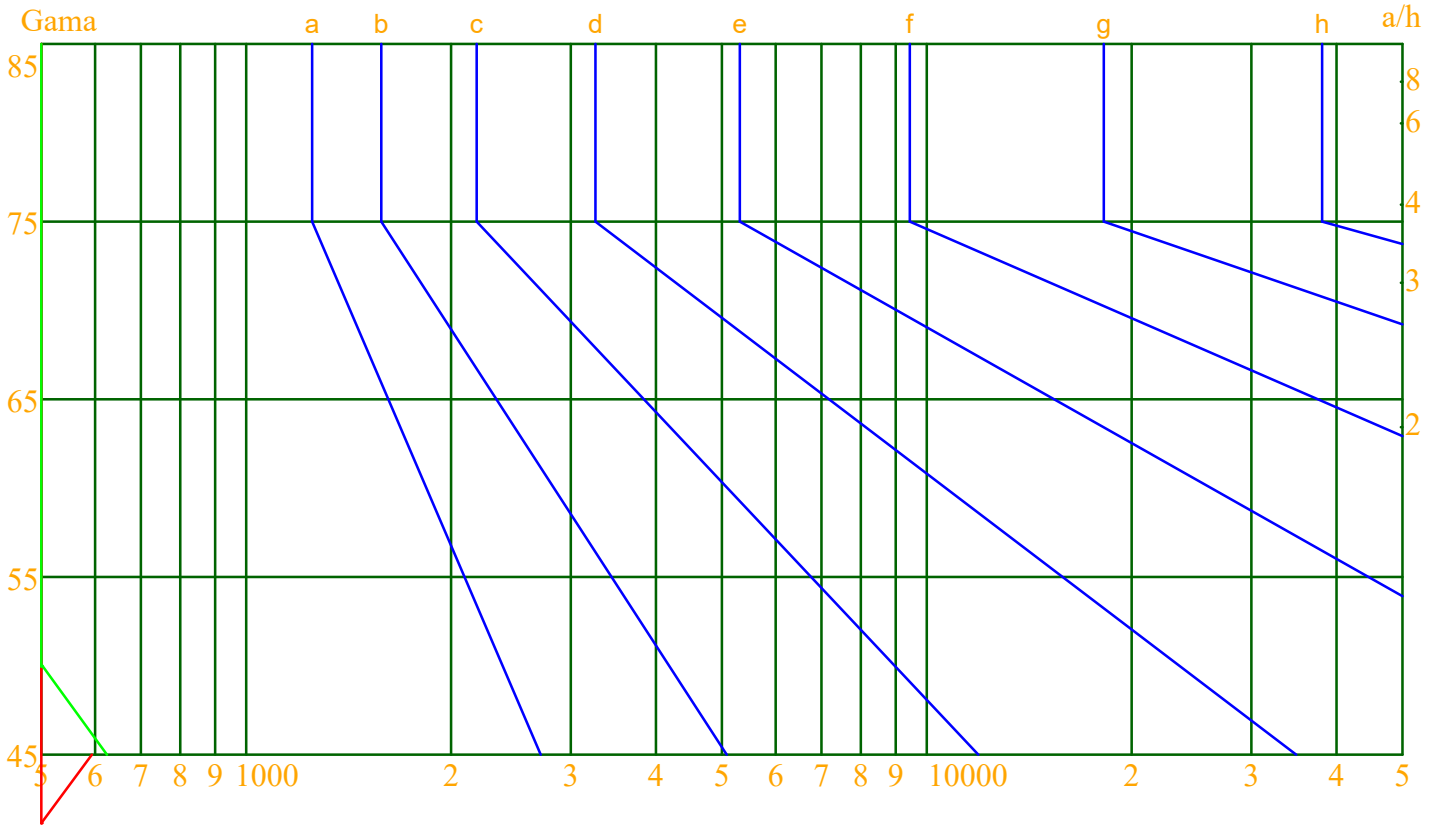

Luminous Size: Length(m)=0.304 Width(m)=0.120 Height(m)=0.060 Area(m²)=0.054720
 Luminous Type: Without Luminous Side
 Luminous Curves: C0-C180 Color: — C90-C270 Color: —

IES Indoor Report

Photometric Filename: TT-2216-L1500-3000K-5-Smoke LENS.IES

Indoor Budgetary Estimate Table

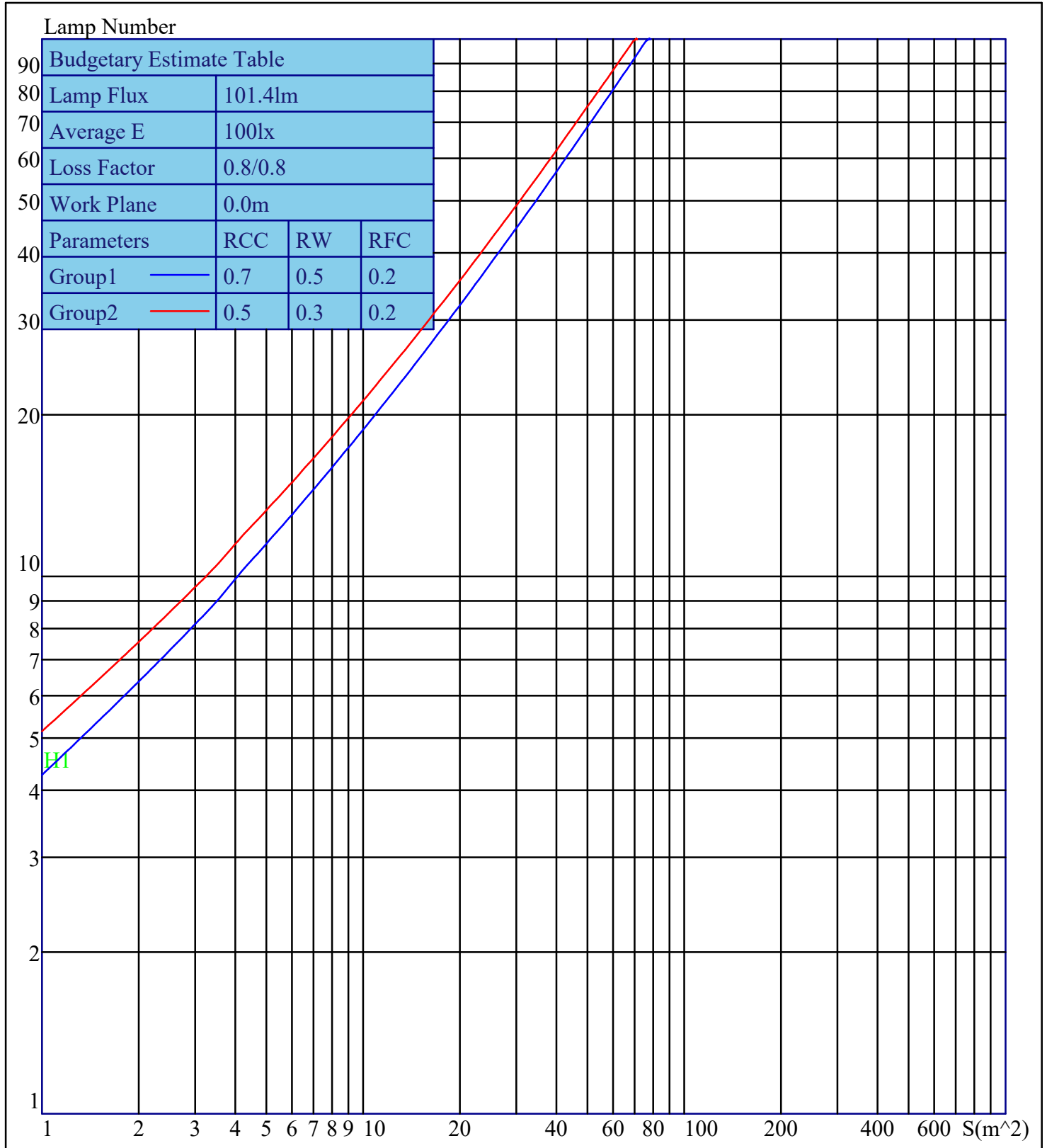

Parameters1: Rhocc = 0.7 Rhow = 0.5 Rhofc = 0.2 LLF = 0.8
 Parameters2: Rhocc = 0.5 Rhow = 0.3 Rhofc = 0.2 LLF = 0.8
 Average Illuminance(lx): 100 Cavity Height: H1(m) = 2