

TITANIUM

TECHNOLOGY

TT-2216-L1500



- Del SMD2216 tape in 5 meter roll.

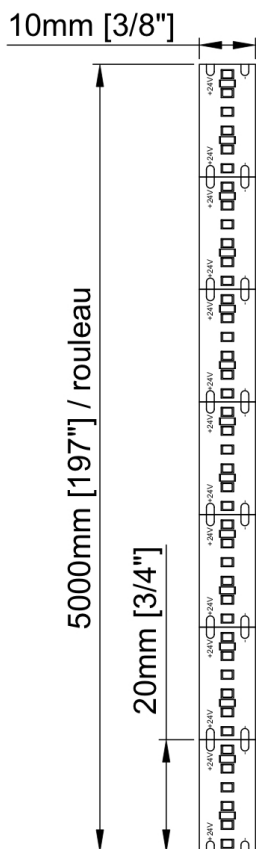

Voltage	24vDC	
LED/m	300 / m	
Power	34,12w / m 10,40w / feet 170,56w / roll	
Amperage	1,34 / m 0,44 / feet 7,11 / roll	
Lumen	27K - 426 lm / feet 30K - 425 lm / feet 35K - 432 lm / feet 40K - 451 lm / feet 60K - 503 lm / feet	51 lm / w 52 lm / w - - 61 lm / w
CRI	90	
Angle	120°	
Size	IP20	10mm x 1,1mm x 5000mm $\frac{3}{8}$ " x $\frac{1}{16}$ " x 196 $\frac{7}{8}$ "
	IP65	10mm x 2,5mm x 5000mm $\frac{3}{8}$ " x $\frac{1}{8}$ " x 196 $\frac{7}{8}$ "
	IP67	13mm x 5mm x 5000mm $\frac{1}{2}$ " x $\frac{3}{16}$ " x 196 $\frac{7}{8}$ "
Cut line	20 mm $\frac{3}{4}$ "	
Finish	White	
Dimmable	Yes	
LED Colour	27K - Warm white 2700K 30K - Warm white 3000K 35K - Neutral white 3500K 40K - Neutral white 4000K 60K - Cold white 6000K R - Red G - Green B - Blue A - Amber	
Working temp.	-40°C ~ 70°C	
IP	20, 65, 67	

PRODUCT CODE

TT	SMD	LED PER ROLL	IP	LED COLOR	VOLTAGE
TT	2216	L1500	20	27K	24V
TT	2216	L1500			24V

IES Indoor Report

Photometric Filename:TT-2216-L1500-3000K-2-Frosted LENS.IES

Indoor Luminaire Photometric Data

Description Information

Luminaire Name: TT-2216-L1500-3000k-2-Frosted lens		Luminaire Catalog:	Test ID:
Lamp Name: TT-2216-L1500-3000k-2-Frosted lens		Lamp Catalog: 2216	Test Date: 2021/03/17
Manufacture: TITANIUM TECHNOLOGIE		ShieldingAngle(°):	Test Machine: GON-2000
Test Lab:		Frequency(Hz):	Luminaire CCT(K):
Luminaire Size(W*L*H): 0.120*0.304*0.060		Lighting Area(m2): 0.055	Luminaire Weight(kg): 0.100
Test System: C, γ	Test Step: C=45.0 γ =1.0	Temperature(°C): 25	Humidity(%):

Character Parameter

Lamp Speciality Parameter	
Lamp Rated Lumens(lm): 448.000	Lamp Number in Luminaire: 1
Lamp Norminal Power(W):	Lamp Rated Voltage(V):
Lamp Tested Power(W): 8.243	Lamp Tested Voltage(V): 24.5
Lamp Tested Current(A): 0.336	Lamp Tested PF:
Lamp Size(W*L*H): 0.120*0.304*0.060	
Luminaire Speciality	
Luminaire Lumens(lm): 291.278	Beam Angle(10%Imax): 98.5
Luminaire Efficiency: 65.02%	Left=-48.3 Right=50.2
Luminaire EER(lm/W): 35.336	Field Angle(10%Imax): 146.4
Muximum Cand.(cd): 127.938	Spacing Criteria S/MH(C0_180): 1.165
Max Cd. Angle(°): C=270.0 γ =1.0	Spacing Criteria S/MH(C90_270): 1.176
Downward Lumens(lm): 291.278	CIE Type: Semi-Direct
Upward Lumens(lm): 0.000	ErP ϕ use(120deg): 252.676lm
Downward Total Efficiency%: 100.00	IRF(%): 122.990
Upward Total Efficiency%: 0.00	

IES Indoor Report

Photometric Filename: TT-2216-L1500-3000K-2-Frosted LENS.IES

2D Light Intensity Distribution Curve

Plane [50%Ang.] [10%Ang.]

C270.0: 98.5 146.4

C0.0: 97.3 146.0

C90.0: 98.5 146.4

Polar Graph

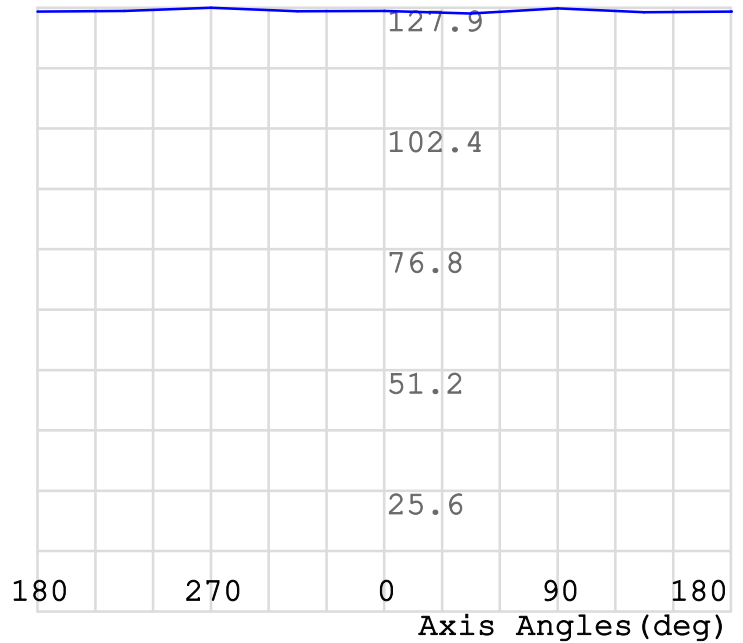
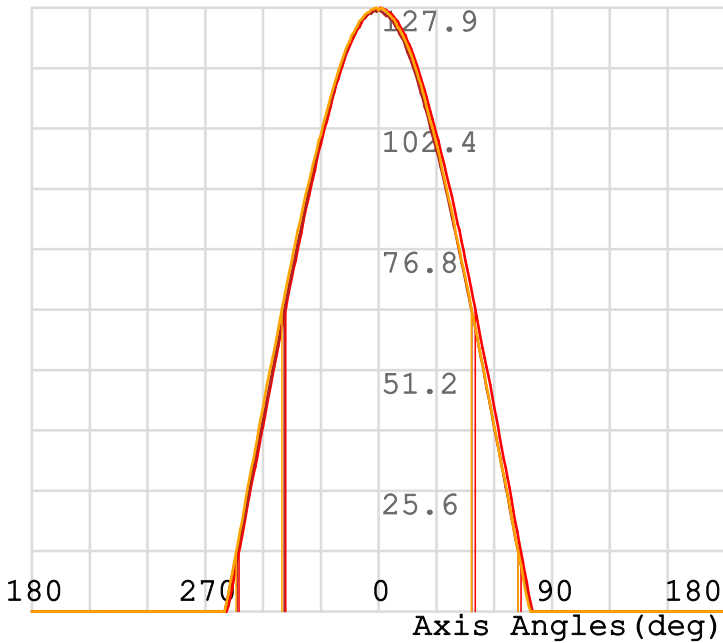
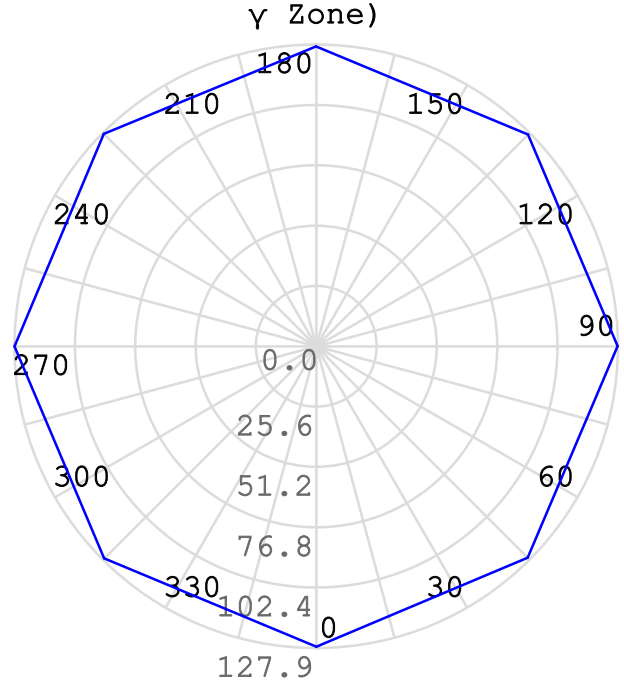
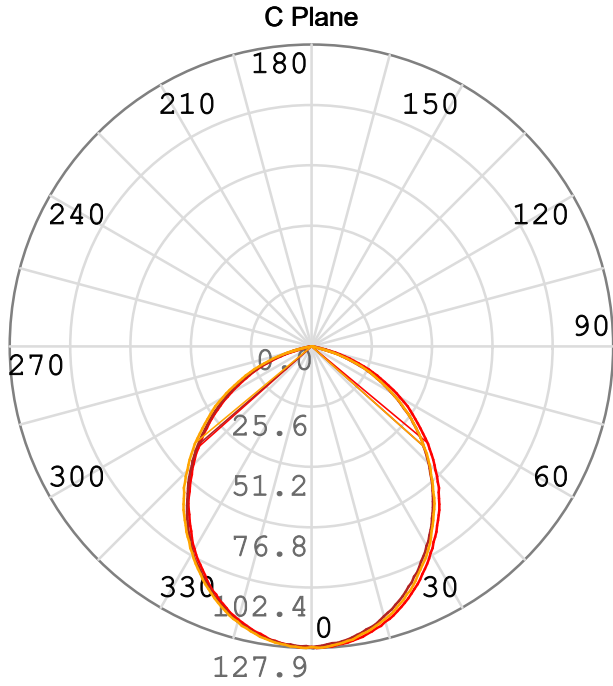

C Plane: C270.0_90.0 ——— C0.0_180.0 ——— C90.0_270.0 ———
 γ Cone: γ1.0 ———

3D Light Intensity Distribution Curve

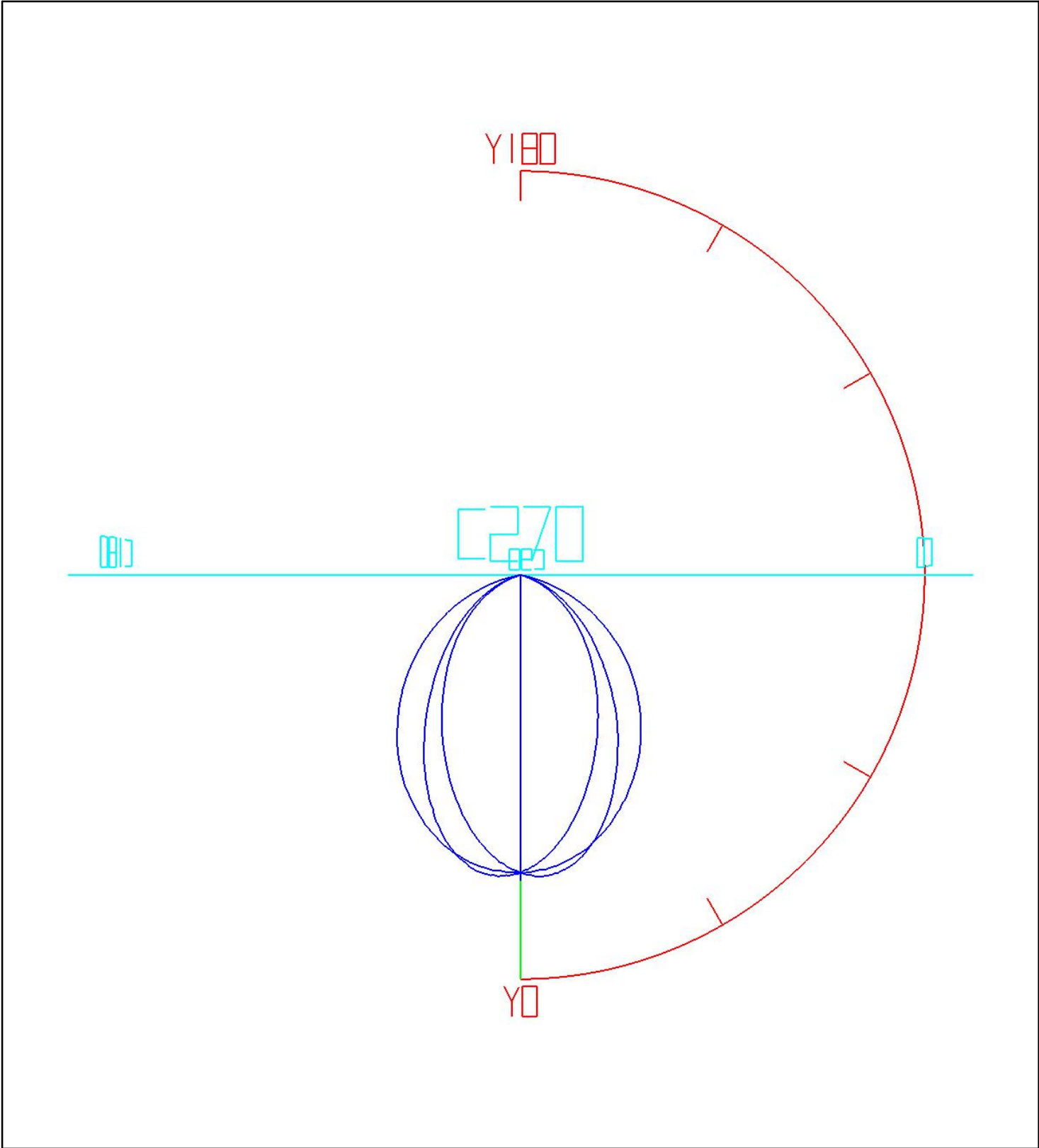

Curves: 3D Model ——— Fixture ——— Vert. HUD ——— Hori. HUD ———
View Angles: Orient:0 Tilt:0 Roll:0 Spin:0

IES Indoor Report

Photometric Filename: TT-2216-L1500-3000K-2-Frosted LENS.IES

Rectangle ISO Light Intensity Curve

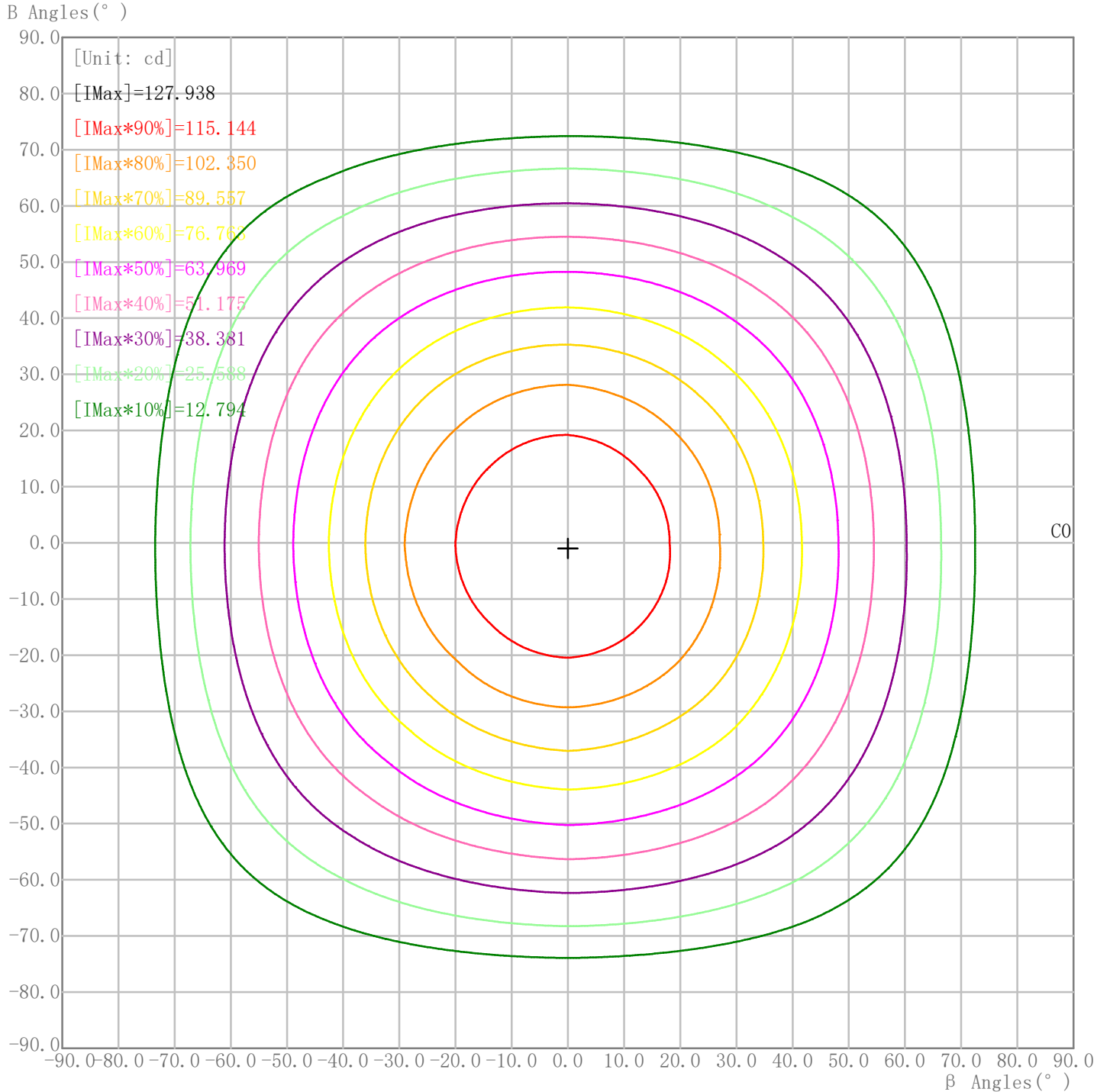

Curves: 90% — 80% — 70% — 60% — 50% — 40% — 30% — 20% — 10% —

Maximum Light Intensity(cd): 127.94 Maximum Cd. Angles: H-0.0 V-1.0

IES Indoor Report

Photometric Filename: TT-2216-L1500-3000K-2-Frosted LENS.IES

Plane ISO-Illuminance Curve

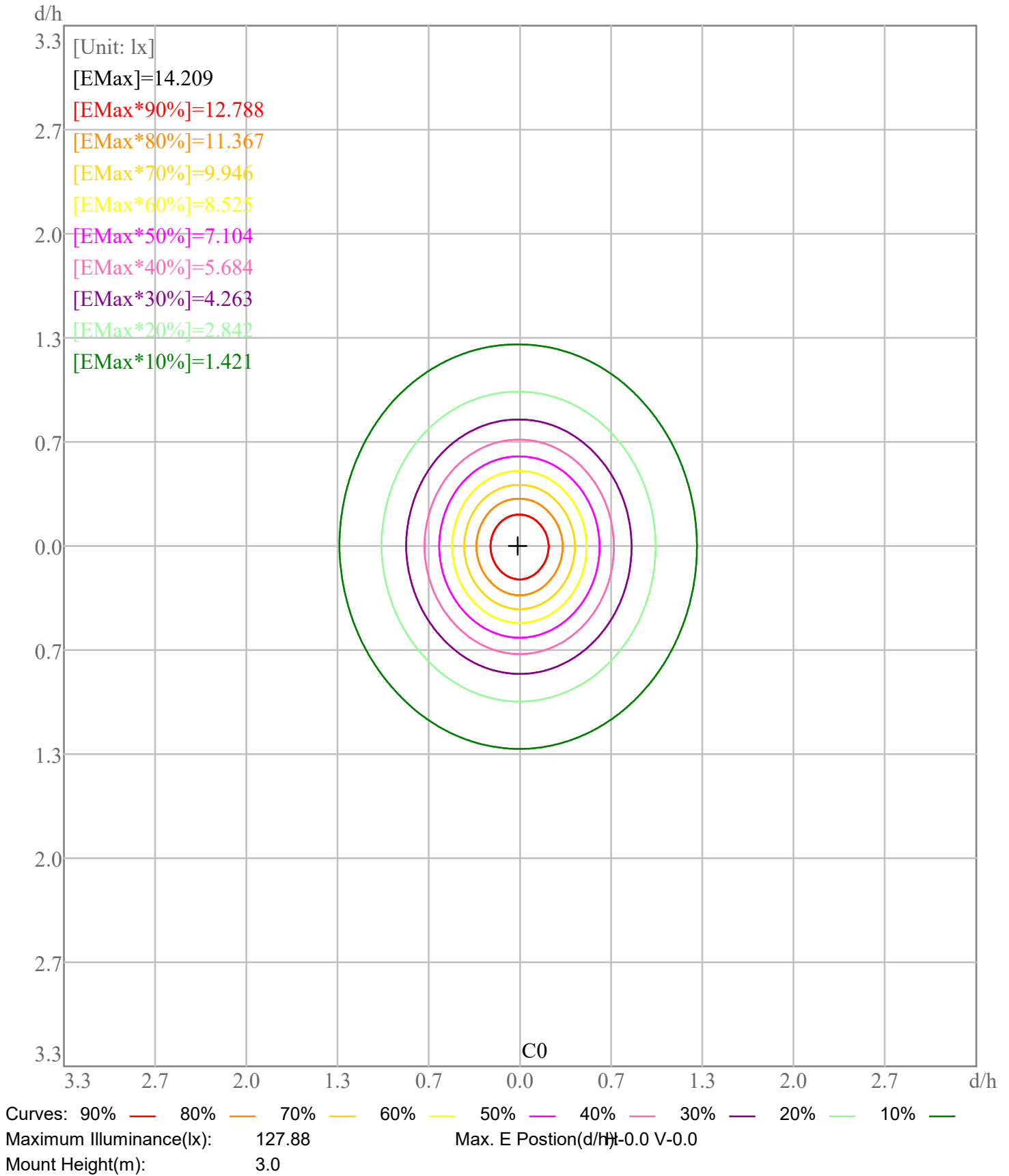

3D Plane ISO Illuminance Curve

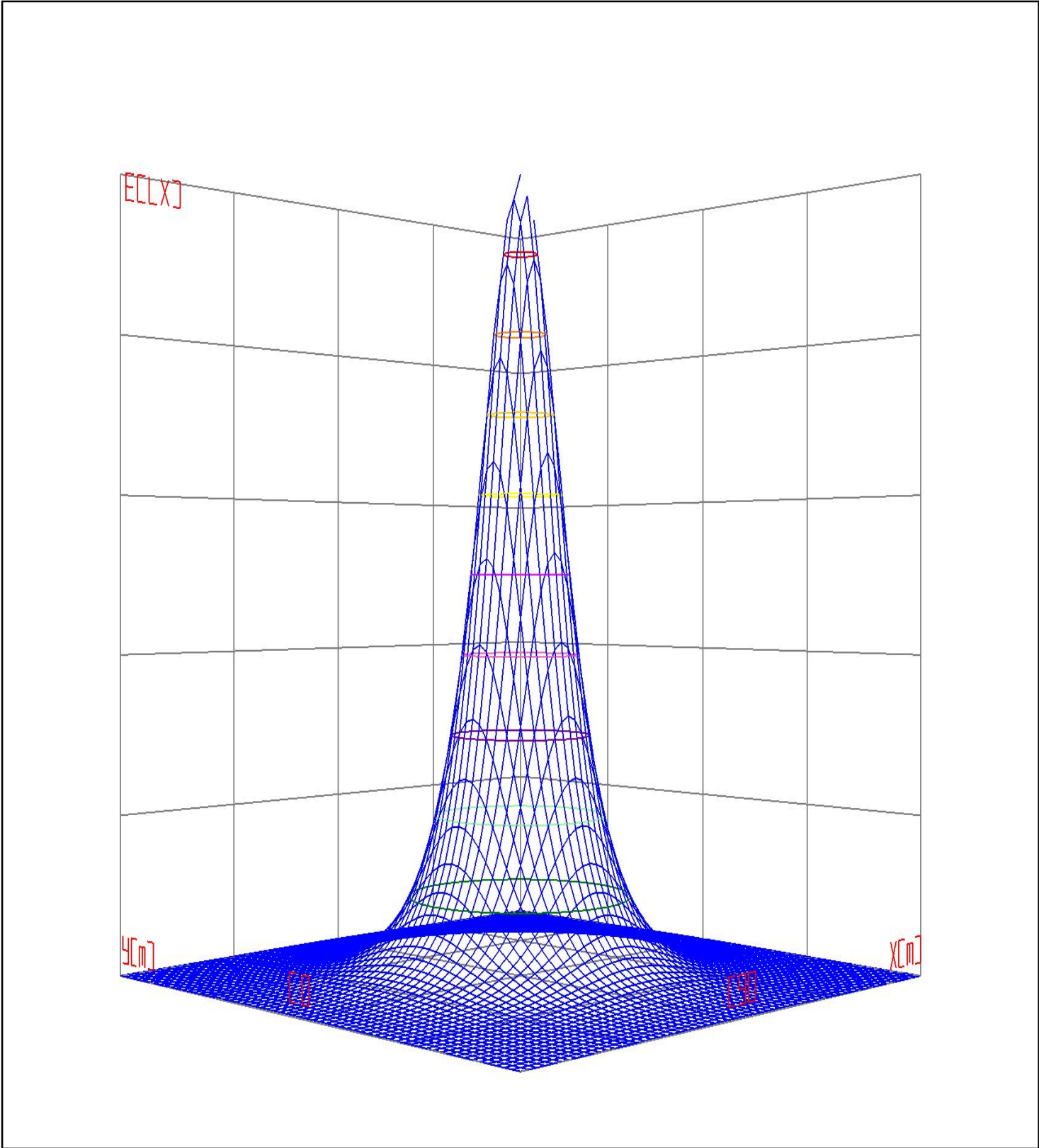

Curves: 3D Model — 90% — 80% — 70% — 60% — 50% — 40% — 30% — 20% — 10% —
View Angles(deg): 0 Height(m): 3.0 Distance(m): 10.0

IES Indoor Report

Photometric Filename: TT-2216-L1500-3000K-2-Frosted LENS.IES

Space ISO Illuminance Curve

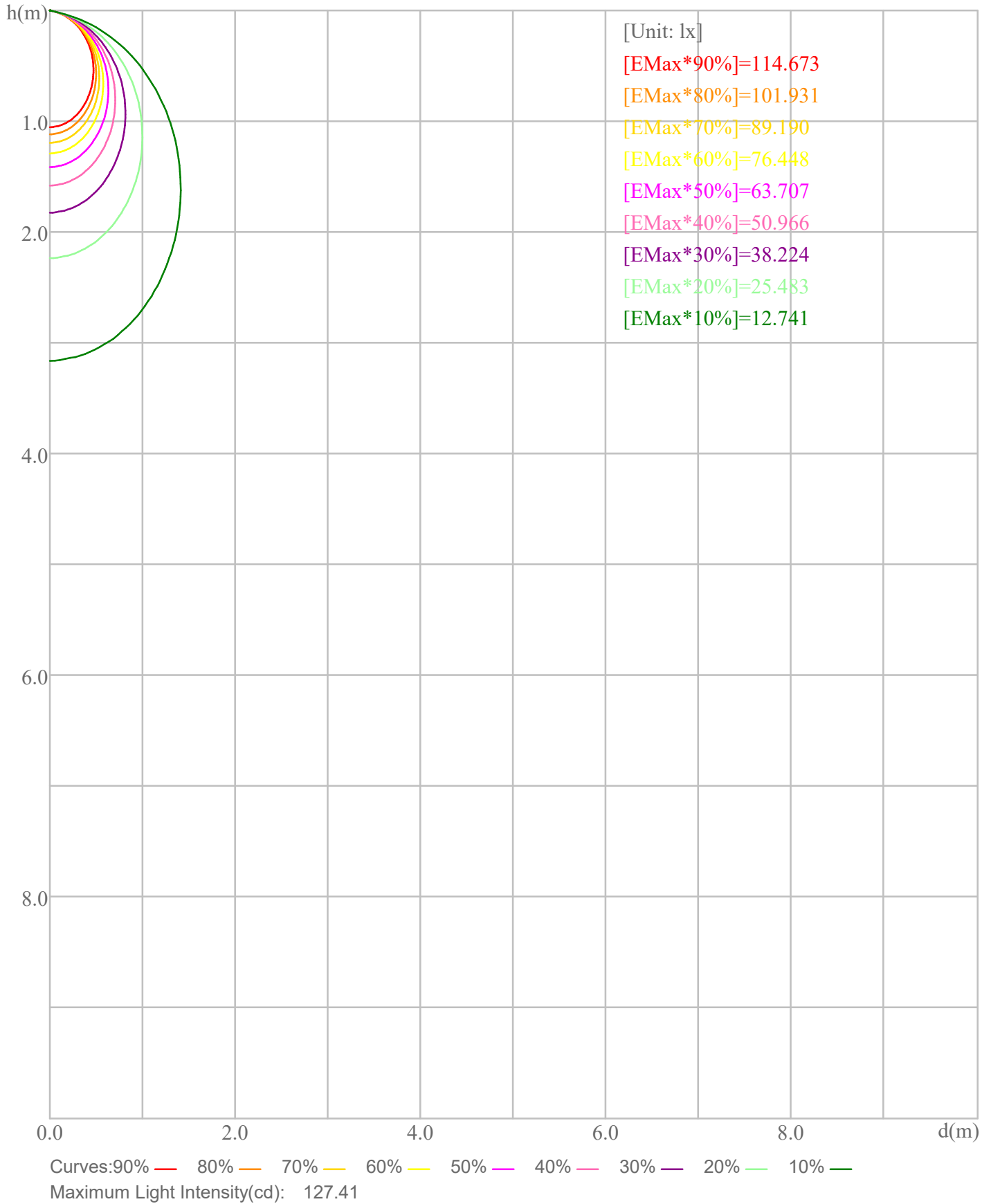

Illuminance-Distance Curve

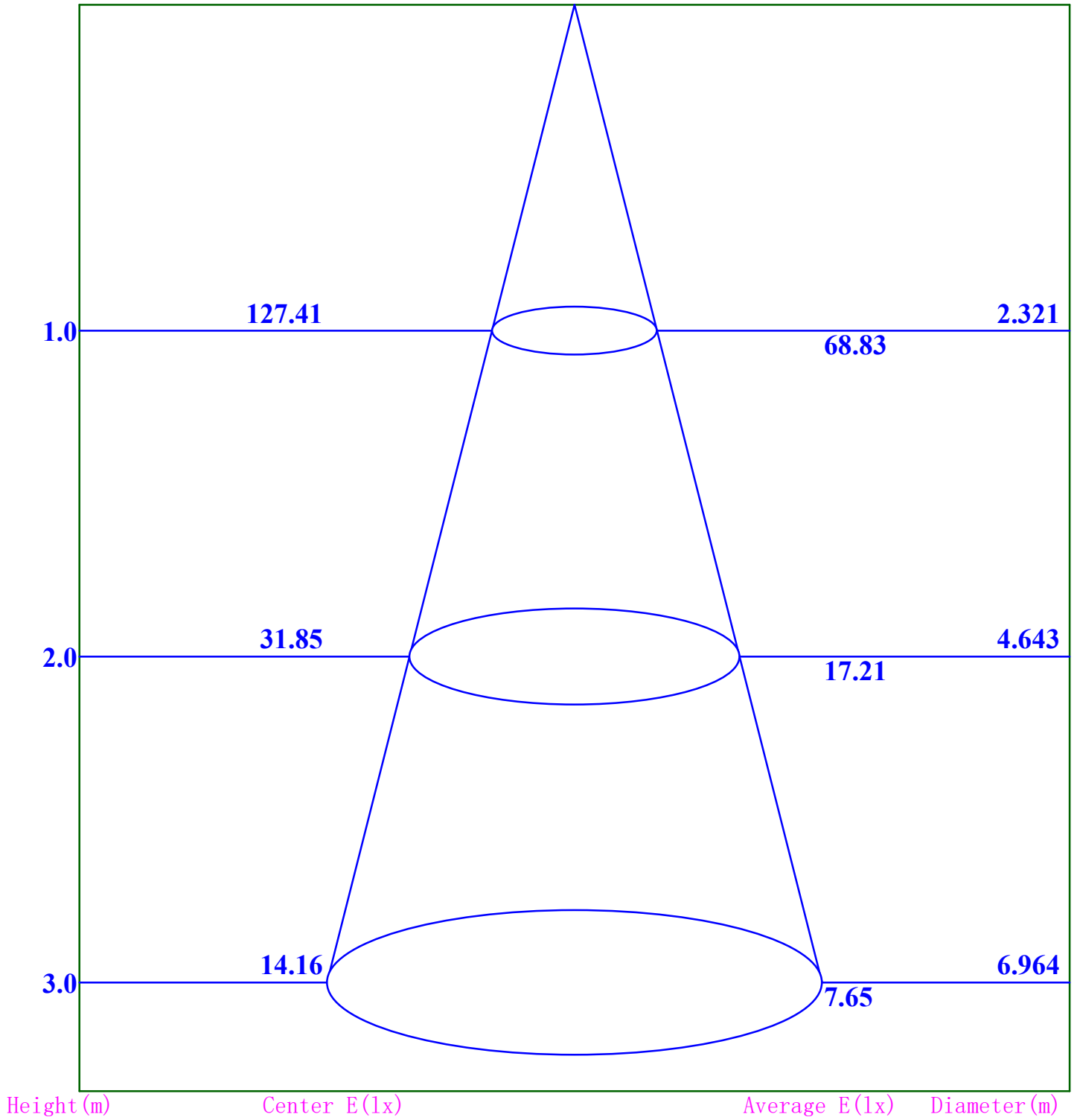

Beam Angle:98.5

IES Indoor Report

Photometric Filename:TT-2216-L1500-3000K-2-Frosted LENS.IES

Indoor Luminance Limiting Curve

Glare Grade Table

GI	Quality	Using Illuminance							
		a	b	c	d	e	f	g	h
1.15	A	2000	1000	500	<=300				
1.5	B		2000	1000	500	<=300			
1.85	C			2000	1000	500	<=300		
2.2	D				2000	1000	500	<=300	
2.55	E					2000	1000	500	<=300
		a	b	c	d	e	f	g	h

Luminance Table

Gama(deg)	45	50	55	60	65	70	75	80	85
C0	1817	1720	1589	1423	1244	956	538	0	0
C90	1828	1720	1597	1433	1252	958	527	0	0

Luminance Limiting Curve

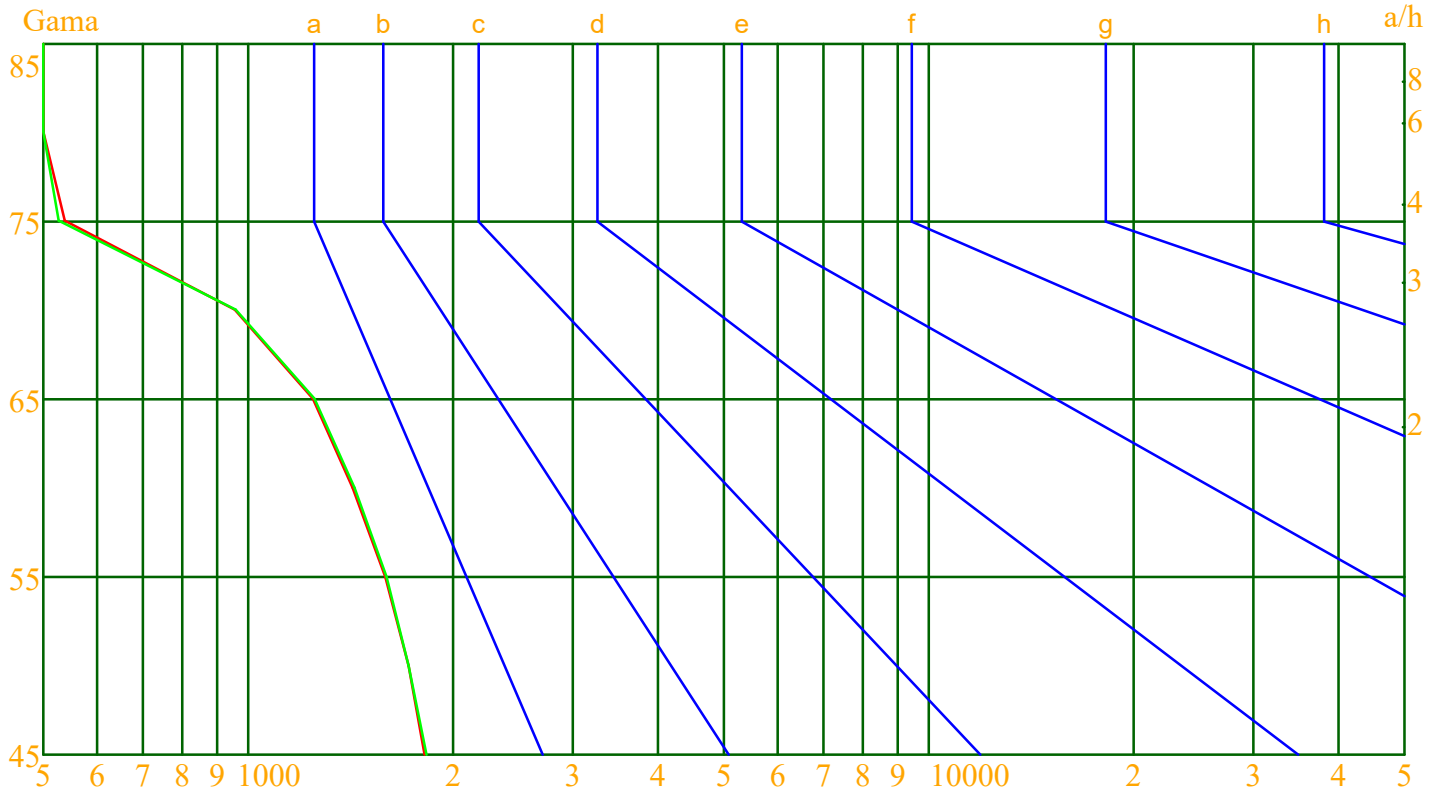

Luminous Size: Length(m)=0.304 Width(m)=0.120 Height(m)=0.060 Area(m²)=0.054720
 Luminous Type: Without Luminous Side
 Luminous Curves: C0-C180 Color: — C90-C270 Color: —

TITANIUM

TECHNOLOGY

TT-2216-L1500



- Del SMD2216 tape in 5 meter roll.

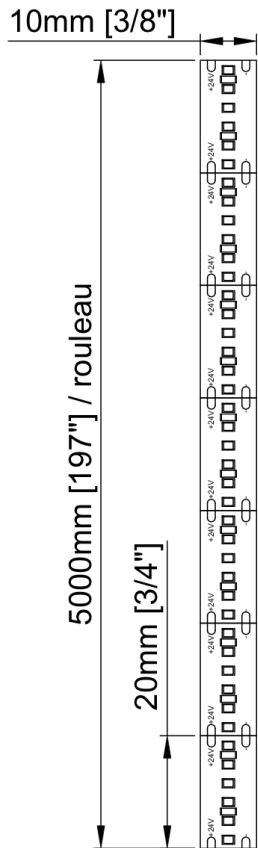

Voltage	24vDC	
LED/m	300 / m	
Power	34,12w / m 10,40w / feet 170,56w / roll	
Amperage	1,34 / m 0,44 / feet 7,11 / roll	
Lumen	27K - 1399 lm 30K - 1403 lm 35K - 1438 lm 40K - 1502 lm 60K - 1649 lm	
CRI	90	
Angle	120°	
Size	IP20	10mm x 1,1mm x 5000mm $\frac{3}{8}$ " x $\frac{1}{16}$ " x 196 $\frac{7}{8}$ "
	IP65	10mm x 2,5mm x 5000mm $\frac{3}{8}$ " x $\frac{1}{8}$ " x 196 $\frac{7}{8}$ "
	IP67	13mm x 5mm x 5000mm $\frac{1}{2}$ " x $\frac{3}{16}$ " x 196 $\frac{7}{8}$ "
Cut line	20 mm $\frac{3}{4}$ "	
Finish	White	
Dimmable	Yes	
LED Colour	27K - Warm white 2700K 30K - Warm white 3000K 35K - Neutral white 3500K 40K - Neutral white 4000K 60K - Cold white 6000K R - Red G - Green B - Blue A - Amber	
Working temp.	-40°C ~ 70°C	
IP	20, 65, 67	

Indoor Budgetary Estimate Table

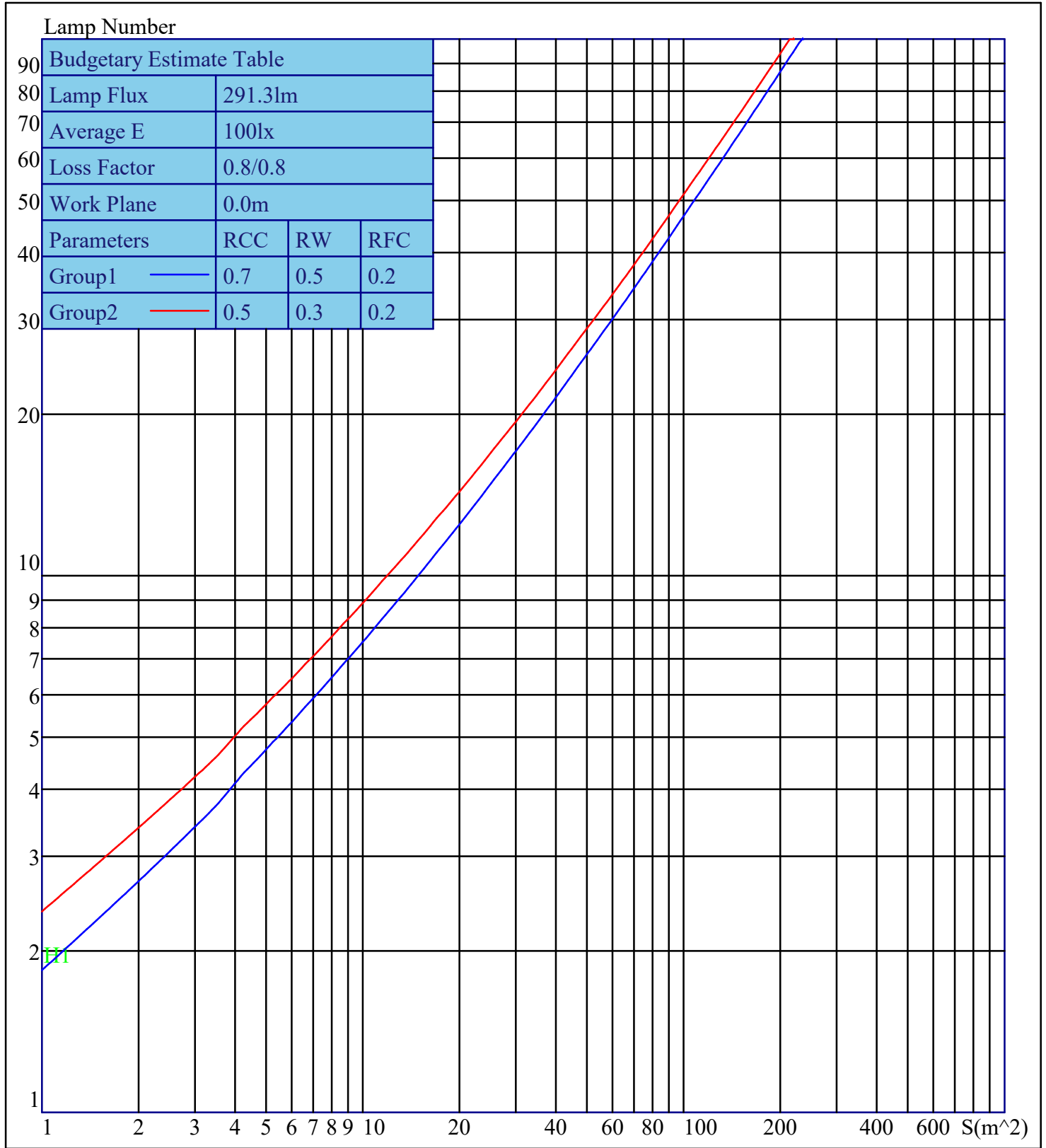

Parameters1: Rhocc = 0.7 Rhow = 0.5 Rhofc = 0.2 LLF = 0.8
 Parameters2: Rhocc = 0.5 Rhow = 0.3 Rhofc = 0.2 LLF = 0.8
 Average Illuminance(lx): 100 Cavity Height: H1(m) = 2