

TITANIUM

TECHNOLOGY

TT-3528-L600



- 5m roll of SMD3528 LED Strip in 5 meter roll.

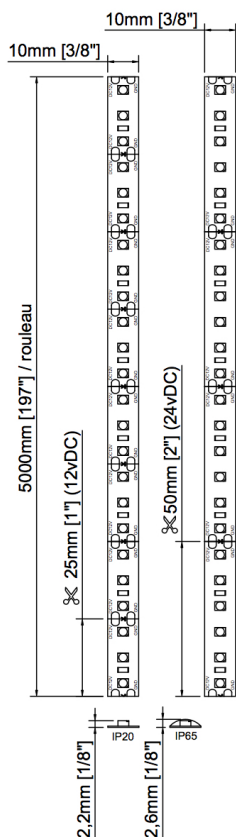

Voltage	12vDC	24vDC
LED/m	120 / m	
Power	9,84w / m 3w / feet 49,2w / roll	
Amperage	0,82A / m 0,25A / feet 4,1A / roll	0,41A / m 0,13A / feet 2,05A / roll
Lumen	27K - 117 lm / feet 30K - 119 lm / feet 35K - 91 lm / feet 40K - 104 lm / feet 60K - 88 lm / feet	45 lm / w 44 lm / w 35 lm / w 39 lm / w 33 lm / w
CRI (RA)	90	
Angle	120°	
Size	IP20	10mm x 2,2mm x 5000mm $\frac{3}{8}$ " x $\frac{1}{8}$ " x 196 $\frac{7}{8}$ "
	IP65	10mm x 2,6mm x 5000mm $\frac{3}{8}$ " x $\frac{1}{8}$ " x 196 $\frac{7}{8}$ "
	IP67	13mm x 5mm x 5000mm $\frac{1}{2}$ " x $\frac{3}{16}$ " x 196 $\frac{7}{8}$ "
Cut line	25 mm 1"	50 mm 2"
Finish	White	
Dimmable	Yes	
LED Colour	27K - Warm white 2700K 30K - Warm white 3000K 35K - Neutral white 3500K 40K - Neutral white 4000K 60K - Cold white 6000K R - Red G - Green B - Blue A - Amber RGB - Color mixing 3:1	
Working temp.	-40°C ~ 70°C	
IP	20, 65, 67	

PRODUCT CODE

TT	SMD	LED PER ROLL	IP	LED COLOR	VOLTAGE
TT	3528	L600	20	27K	24V
TT	3528	L600			

IES Indoor Report

Photometric Filename:TT-3528-L600-4000K-2-Frosted LENS.IES

Indoor Luminaire Photometric Data

Description Information

Luminaire Name: TT-3528-L600-4000K-2-Frosted lens	Luminaire Catalog:	Test ID:
Lamp Name: TT-3528-L600-4000K-2-Frosted lens	Lamp Catalog: 3528	Test Date: 2021/04/12
Manufacture: TITANIUM TECHNOLOGIE	ShieldingAngle(°):	Test Machine: GON-2000
Test Lab:	Frequency(Hz):	Luminaire CCT(K):
Luminaire Size(W*L*H): 0.120*0.304*0.060	Lighting Area(m2): 0.055	Luminaire Weight(kg): 0.100
Test System: C, γ	Test Step: C=45.0 γ =1.0	Temperature(°C): 25
		Humidity(%):

Character Parameter

Lamp Speciality Parameter	
Lamp Rated Lumens(lm): 448.000	Lamp Number in Luminaire: 1
Lamp Norminal Power(W):	Lamp Rated Voltage(V):
Lamp Tested Power(W): 2.658	Lamp Tested Voltage(V): 12.3
Lamp Tested Current(A): 0.217	Lamp Tested PF:
Lamp Size(W*L*H): 0.120*0.304*0.060	
Luminaire Speciality	
Luminaire Lumens(lm): 71.878	Beam Angle(10%Imax): 86.8
Luminaire Efficiency: 16.04%	Left=-42.0 Right=44.9
Luminaire EER(lm/W): 27.042	Field Angle(10%Imax): 128.8
Muximum Cand.(cd): 40.558	Spacing Criteria S/MH(C0_180): 1.122
Max Cd. Angle(°): C=225.0 γ =1.0	Spacing Criteria S/MH(C90_270): 1.106
Downward Lumens(lm): 71.878	CIE Type: Semi-Direct
Upward Lumens(lm): 0.000	ErP ϕ use(90deg): 52.231lm
Downward Total Efficiency%: 100.00	IRF(%): 142.336
Upward Total Efficiency%: 0.00	

IES Indoor Report

Photometric Filename: TT-3528-L600-4000K-2-Frosted LENS.IES

2D Light Intensity Distribution Curve

Plane [50%Ang.] [10%Ang.]

C225.0: 86.8 128.8

C0.0: 86.3 128.9

C90.0: 87.1 128.4

Polar Graph

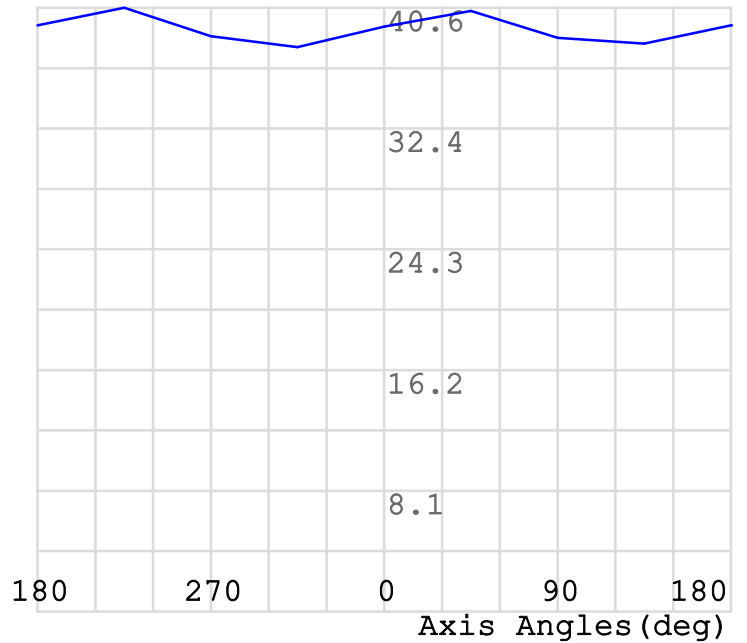
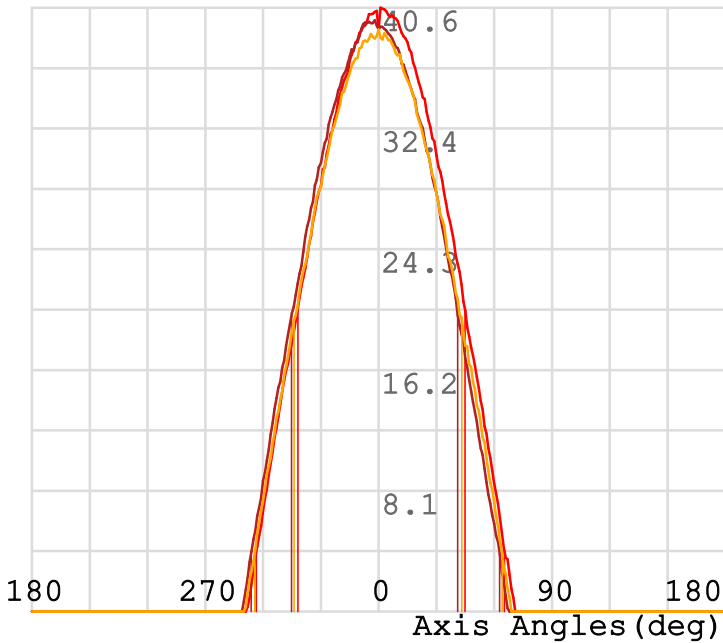
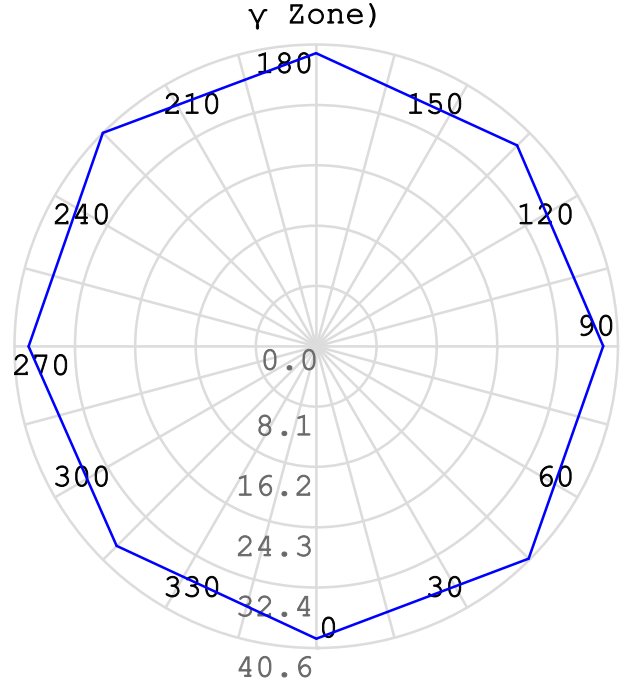
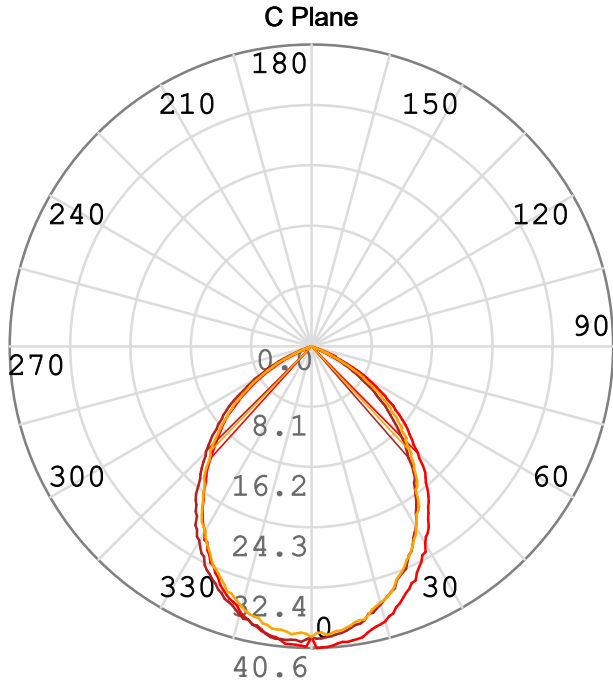

C Plane: C225.0_45.0 ——— C0.0_180.0 ——— C90.0_270.0 ———
 γ Cone: γ1.0 ———

IES Indoor Report

Photometric Filename: TT-3528-L600-4000K-2-Frosted LENS.IES

3D Light Intensity Distribution Curve

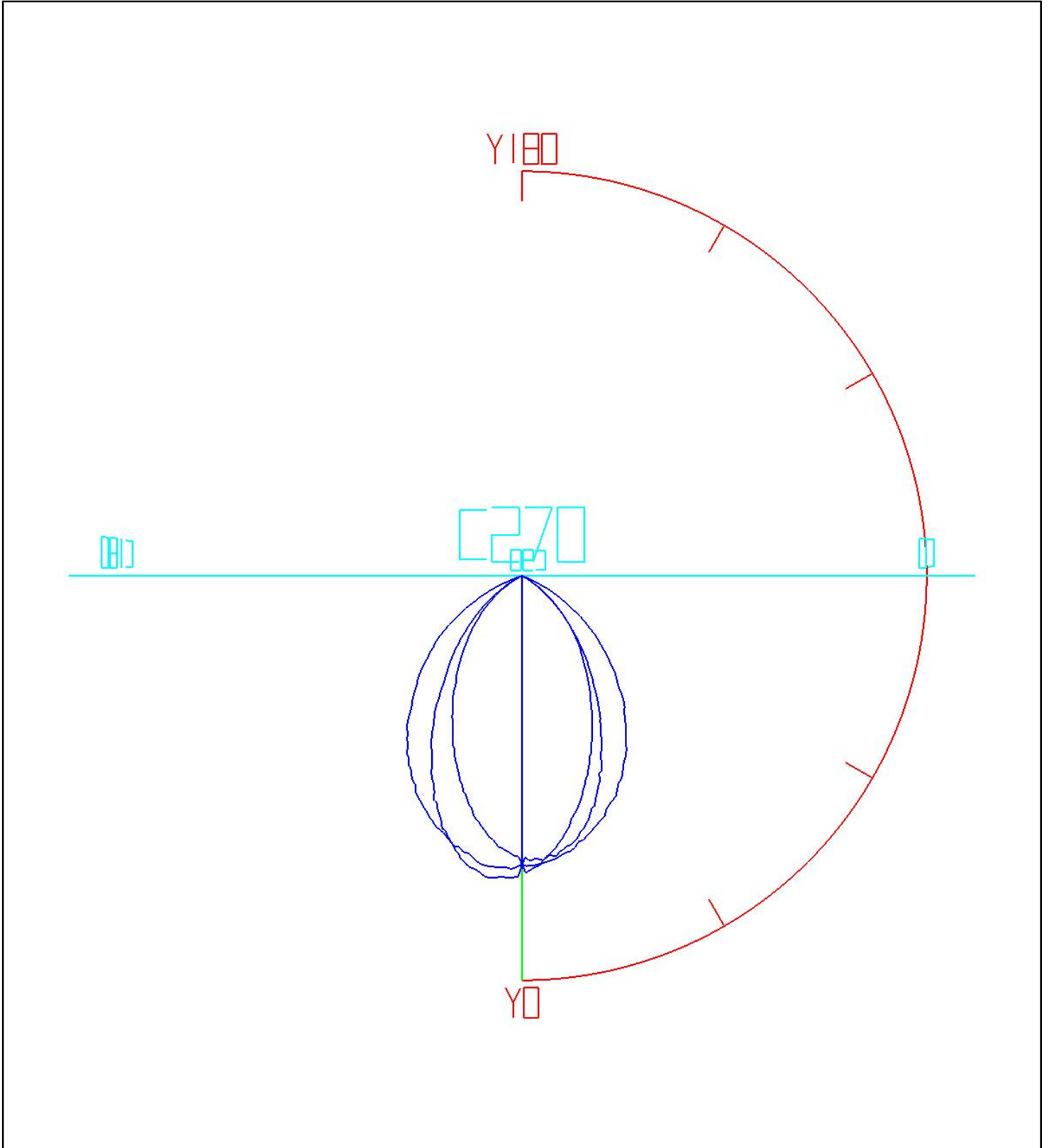

Curves: 3D Model ——— Fixture ——— Vert. HUD ——— Hori. HUD ———
View Angles: Orient:0 Tilt:0 Roll:0 Spin:0

IES Indoor Report

Photometric Filename: TT-3528-L600-4000K-2-Frosted LENS.IES

Rectangle ISO Light Intensity Curve

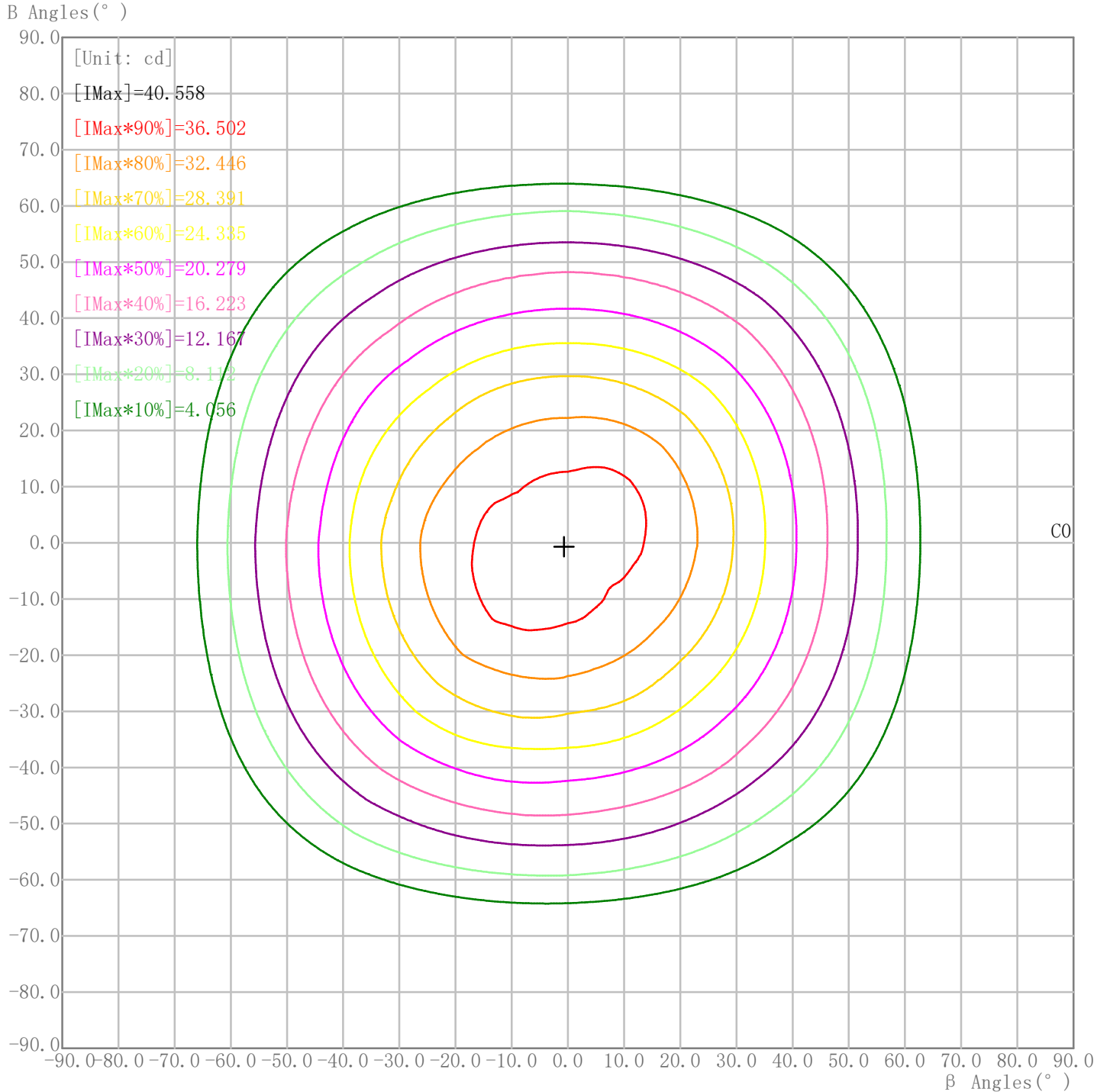

Curves: 90% — 80% — 70% — 60% — 50% — 40% — 30% — 20% — 10% —

Maximum Light Intensity(cd): 40.56

Maximum Cd. Angles: H-0.7 V-0.7

IES Indoor Report

Photometric Filename: TT-3528-L600-4000K-2-Frosted LENS.IES

Plane ISO-Illuminance Curve

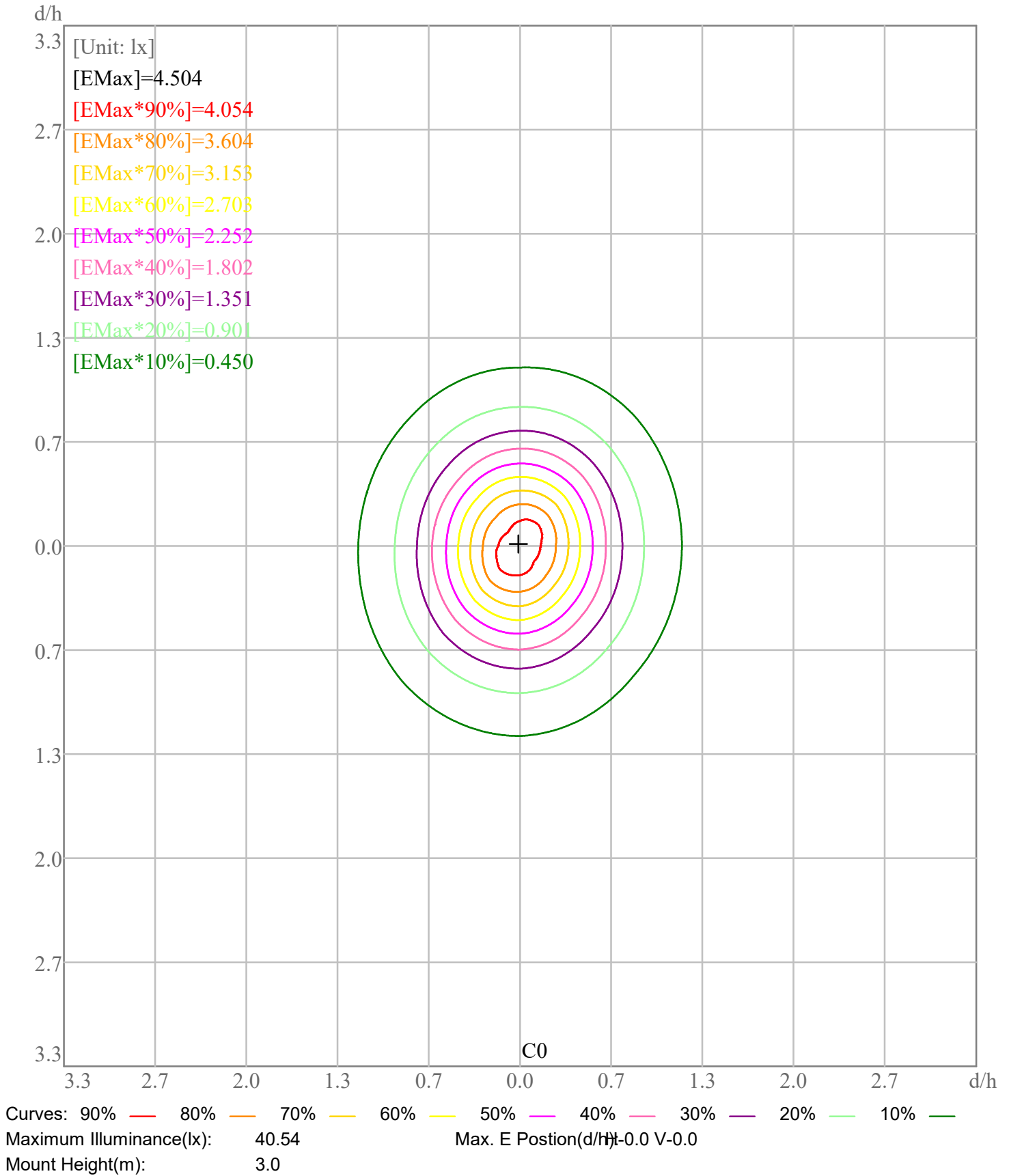

3D Plane ISO Illuminance Curve

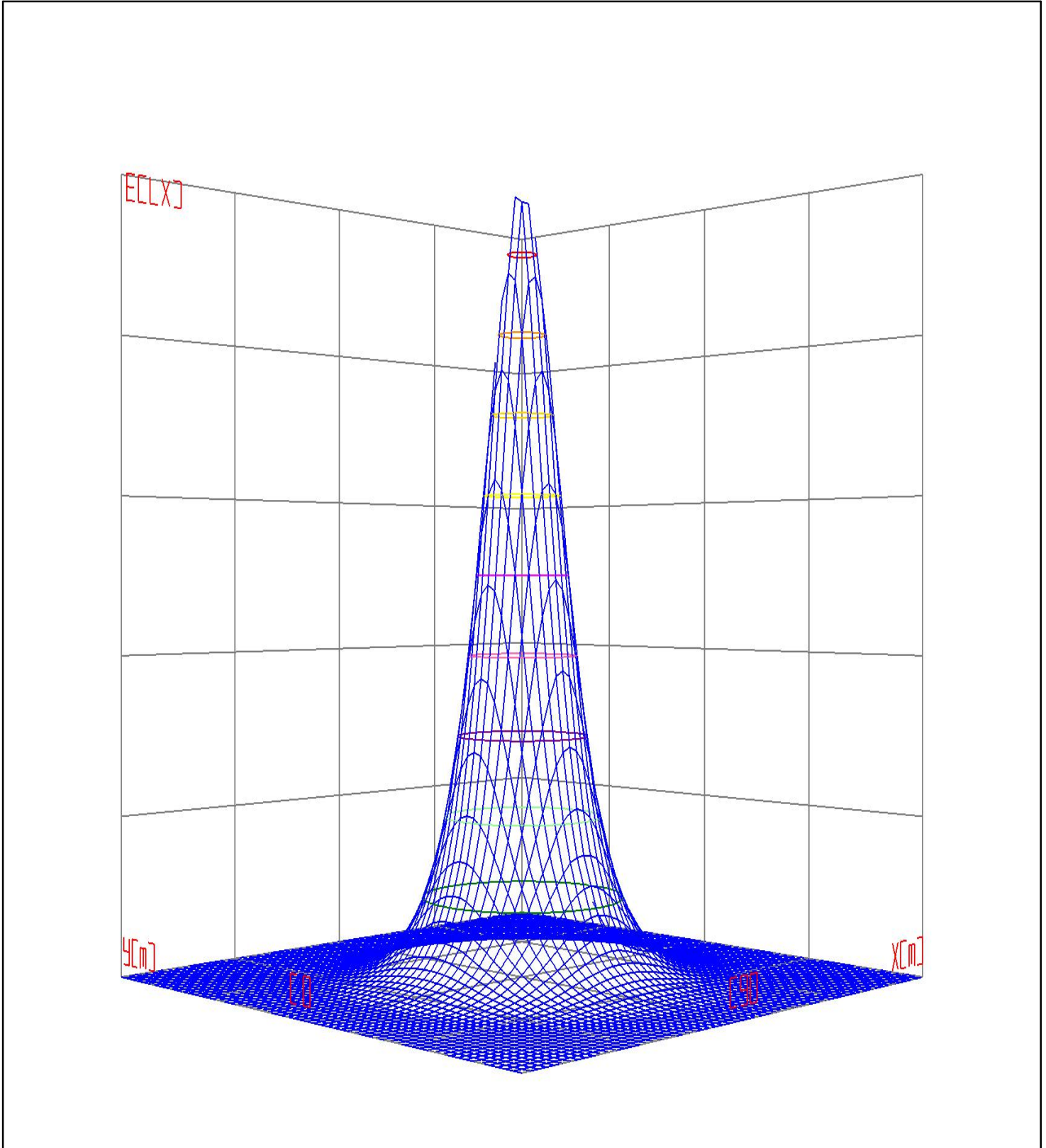

Curves: 3D Model — 90% — 80% — 70% — 60% — 50% — 40% — 30% — 20% — 10% —
View Angles(deg): 0 Height(m): 3.0 Distance(m): 10.0

IES Indoor Report

Photometric Filename: TT-3528-L600-4000K-2-Frosted LENS.IES

Space ISO Illuminance Curve

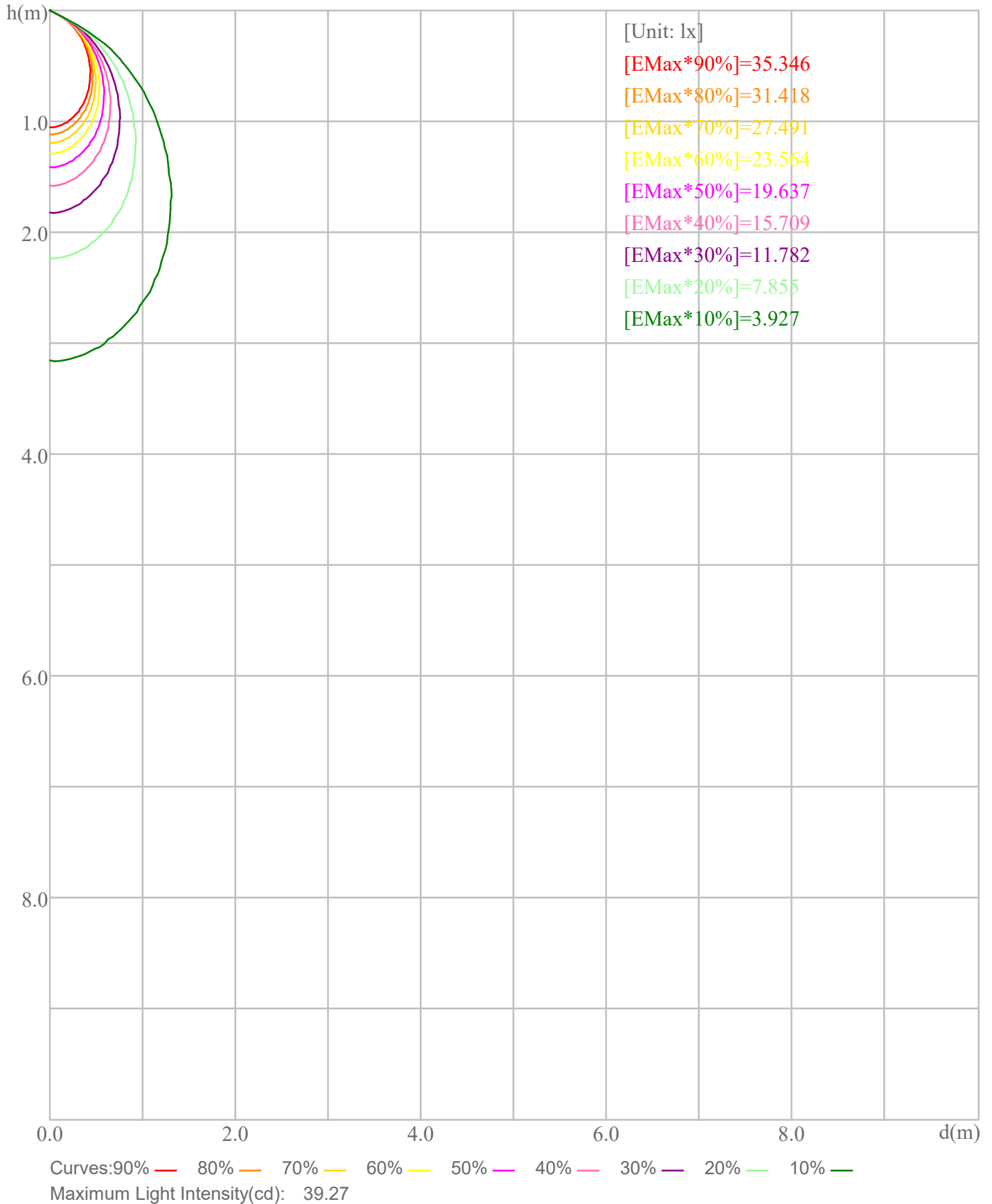

Illuminance-Distance Curve

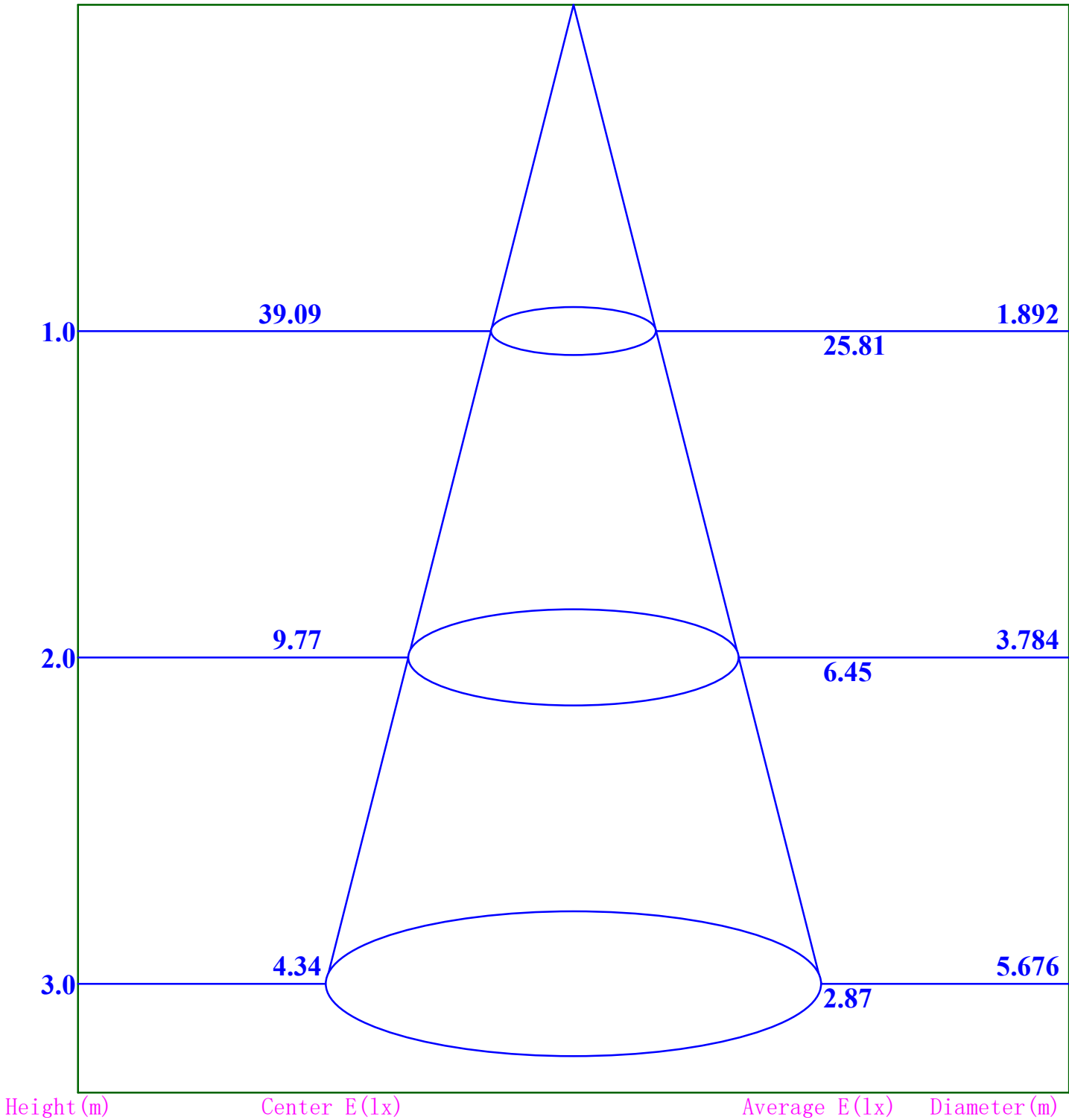

Beam Angle:86.8

IES Indoor Report

Photometric Filename:TT-3528-L600-4000K-2-Frosted LENS.IES

Indoor Luminance Limiting Curve

Glare Grade Table

GI	Quality	Using Illuminance							
		a	b	c	d	e	f	g	h
1.15	A	2000	1000	500	<=300				
1.5	B		2000	1000	500	<=300			
1.85	C			2000	1000	500	<=300		
2.2	D				2000	1000	500	<=300	
2.55	E					2000	1000	500	<=300
		a	b	c	d	e	f	g	h

Luminance Table

Gama(deg)	45	50	55	60	65	70	75	80	85
C0	439	381	305	216	87	0	0	0	0
C90	461	425	361	269	130	0	0	0	0

Luminance Limiting Curve

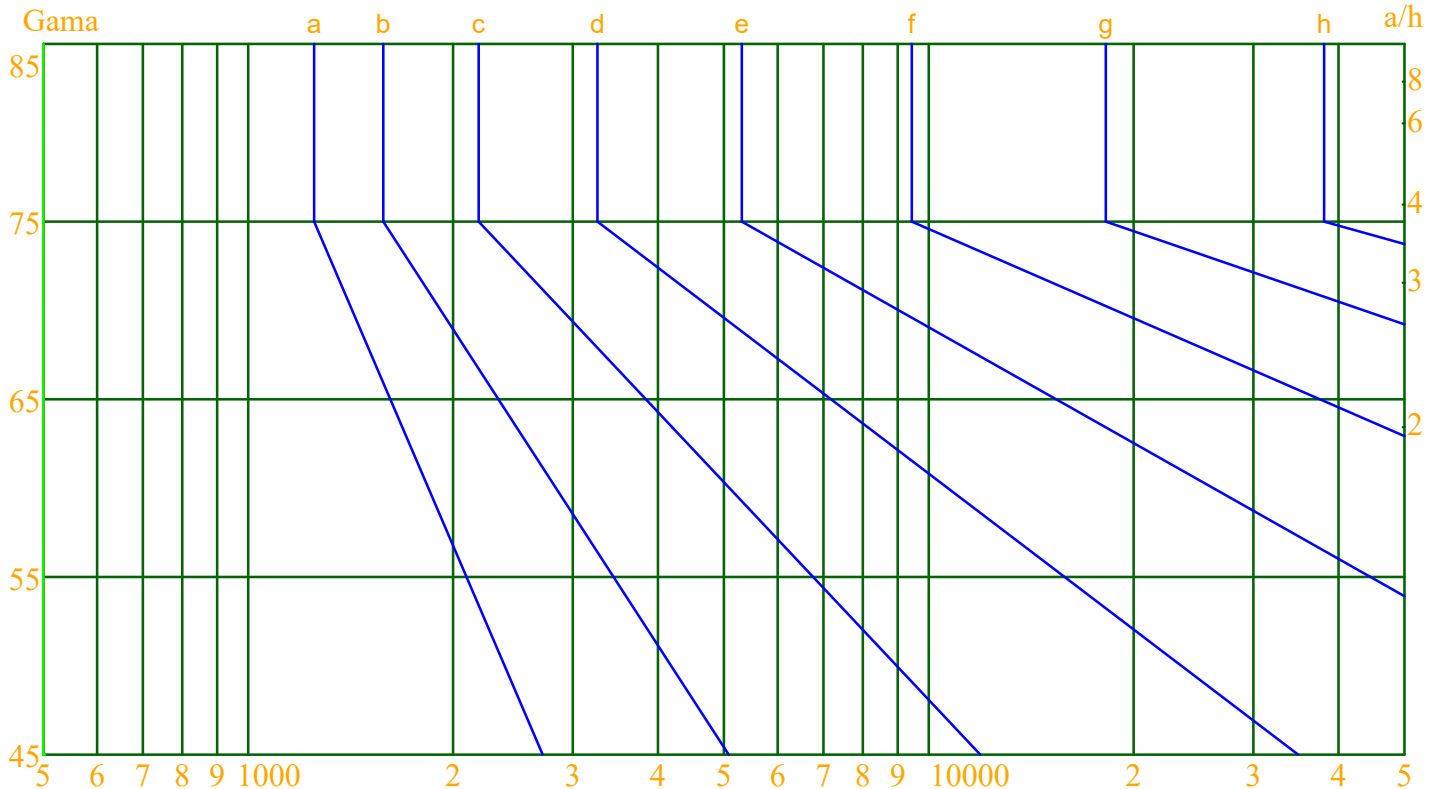

Luminous Size: Length(m)=0.304 Width(m)=0.120 Height(m)=0.060 Area(m²)=0.054720
 Luminous Type: Without Luminous Side
 Luminous Curves: C0-C180 Color: — C90-C270 Color: —

IES Indoor Report

Photometric Filename: TT-3528-L600-4000K-2-Frosted LENS.IES

Indoor Budgetary Estimate Table

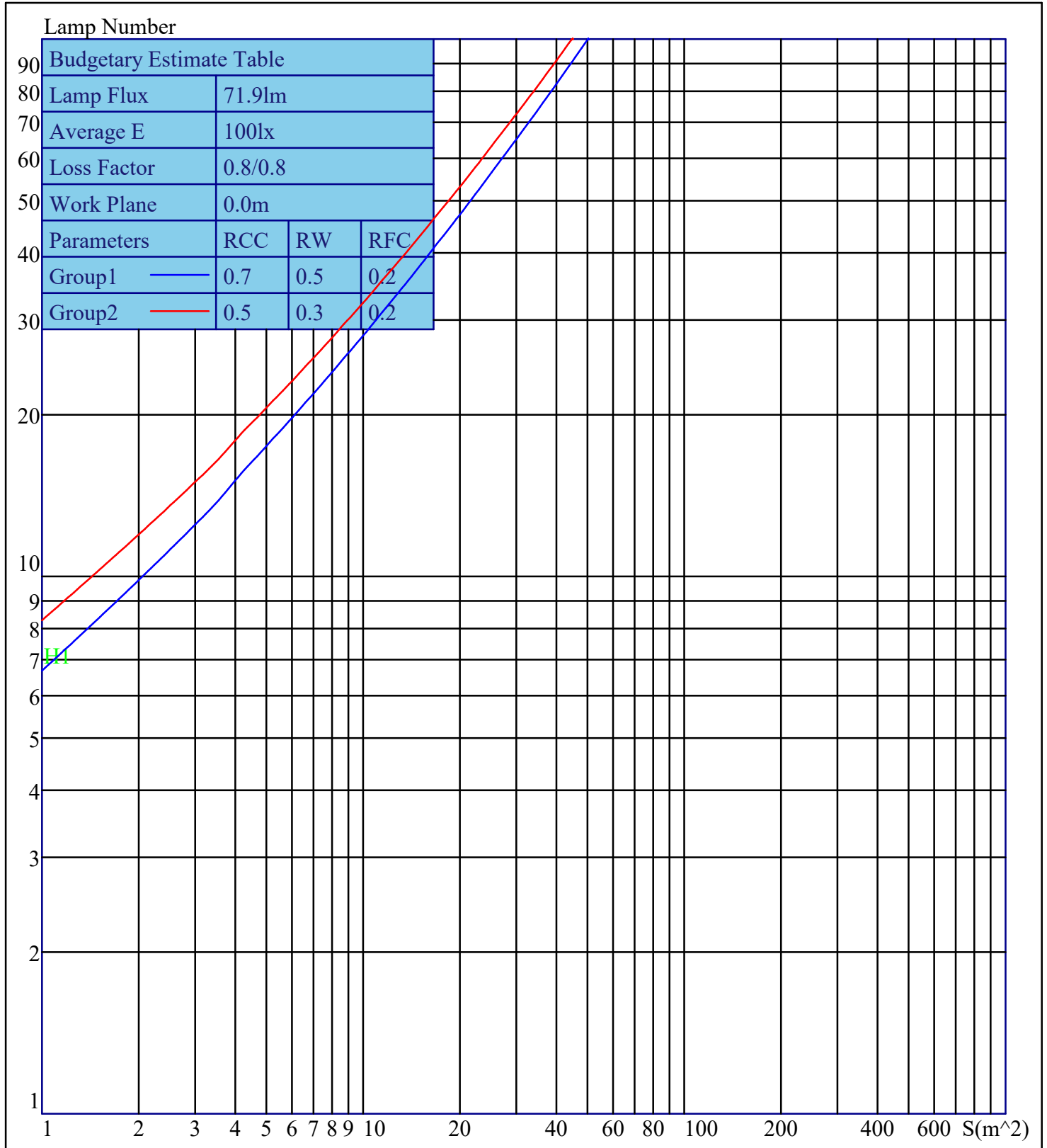

Parameters1: Rhocc = 0.7 Rhow = 0.5 Rhofc = 0.2 LLF = 0.8
 Parameters2: Rhocc = 0.5 Rhow = 0.3 Rhofc = 0.2 LLF = 0.8
 Average Illuminance(lx): 100 Cavity Height: H1(m) = 2