

# TITANIUM

TECHNOLOGIE

TT-2835-L1200



- Ruban DEL SMD2835 en rouleau de 5 mètres.

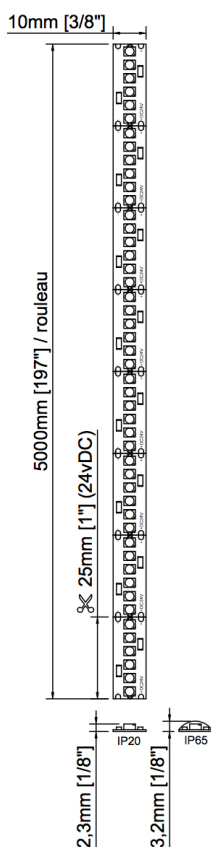

Tension	24vDC	
DEL/m	240 / m	
Puissance	30,4 w / m 9,26 w / pied 152 w / rouleau	
Ampérage	1,27 A / m 0,39 A / pied 6,34 A / rouleau	
Lumens	27K - 448 lm / pied 30K - 456 lm / pied 35K - 452 lm / pied 40K - 422 lm / pied 60K - 384 lm / pied	- 55 lm / w - 64 lm / w 57 lm / w
Angle	120°	
Dimension	IP20	10mm x 2,3mm x 5000mm $\frac{3}{8}$ " x $\frac{1}{8}$ " x 196 $\frac{7}{8}$ "
	IP65	10mm x 3,2mm x 5000mm $\frac{3}{8}$ " x $\frac{1}{8}$ " x 196 $\frac{7}{8}$ "
	IP67	13mm x 5mm x 5000mm $\frac{1}{2}$ " x $\frac{3}{16}$ " x 196 $\frac{7}{8}$ "
Ligne de coupe	25 mm 1"	
Finition	Blanc	
Gradable	Oui	
Couleur DEL	<b>27K</b> - Blanc chaud 2700K <b>30K</b> - Blanc chaud 3000K <b>35K</b> - Blanc neutre 3500K <b>40K</b> - Blanc neutre 4000K <b>60K</b> - Blanc froid 6000K <b>R</b> - Rouge <b>G</b> - Vert <b>B</b> - Bleu <b>A</b> - Ambre	
Temp. fonctionnement	-40°C ~ 70°C	
IP	<b>20, 65, 67</b>	

## CODE PRODUIT

TT	SMD	DEL PAR ROULEAU	IP	COULEUR DEL	TENSION
TT	2835	L1200	20	27K	24V
TT	2835	L1200			24V

# IES Indoor Report

Photometric Filename:TT-2835-L1200-3000K-3-Milky LENS.IES

## Indoor Luminaire Photometric Data

### Description Information

Luminaire Name: TT-2835-L1200-3000k-3-Milky-lens	Luminaire Catalog:	Test ID:
Lamp Name: TT-2835-L1200-3000k-3-Milky-lens	Lamp Catalog: 2835	Test Date: 2021/03/23
Manufacture: TITANIUM TECHNOLOGIE	ShieldingAngle(°):	Test Machine: GON-2000
Test Lab:	Frequency(Hz):	Luminaire CCT(K):
Luminaire Size(W*L*H): 0.120*0.304*0.060	Lighting Area(m2): 0.055	Luminaire Weight(kg): 0.100
Test System: C, $\gamma$	Test Step: C=45.0 $\gamma$ =1.0	Temperature(°C): 25
		Humidity(%):

### Character Parameter

Lamp Speciality Parameter	
Lamp Rated Lumens(lm): 448.000	Lamp Number in Luminaire: 1
Lamp Norminal Power(W):	Lamp Rated Voltage(V):
Lamp Tested Power(W): 8.315	Lamp Tested Voltage(V): 23.7
Lamp Tested Current(A): 0.350	Lamp Tested PF:
Lamp Size(W*L*H): 0.120*0.304*0.060	
Luminaire Speciality	
Luminaire Lumens(lm): 169.102	Beam Angle(10%Imax): 99.9
Luminaire Efficiency: 37.75%	Left=-48.1 Right=51.7
Luminaire EER(lm/W): 20.337	Field Angle(10%Imax): 139.0
Muximum Cand.(cd): 76.339	Spacing Criteria S/MH(C0_180): 1.194
Max Cd. Angle(°): C=90.0 $\gamma$ =4.0	Spacing Criteria S/MH(C90_270): 1.216
Downward Lumens(lm): 169.102	CIE Type: Semi-Direct
Upward Lumens(lm): 0.000	ErP $\phi$ use(120deg): 154.629lm
Downward Total Efficiency%: 100.00	IRF(%): 120.603
Upward Total Efficiency%: 0.00	

# IES Indoor Report

Photometric Filename: TT-2835-L1200-3000K-3-Milky LENS.IES

## 2D Light Intensity Distribution Curve

Plane	[50%Ang.]	[10%Ang.]
C90.0:	99.9	139.0
C0.0:	98.8	137.0
C90.0:	99.9	139.0

Polar Graph

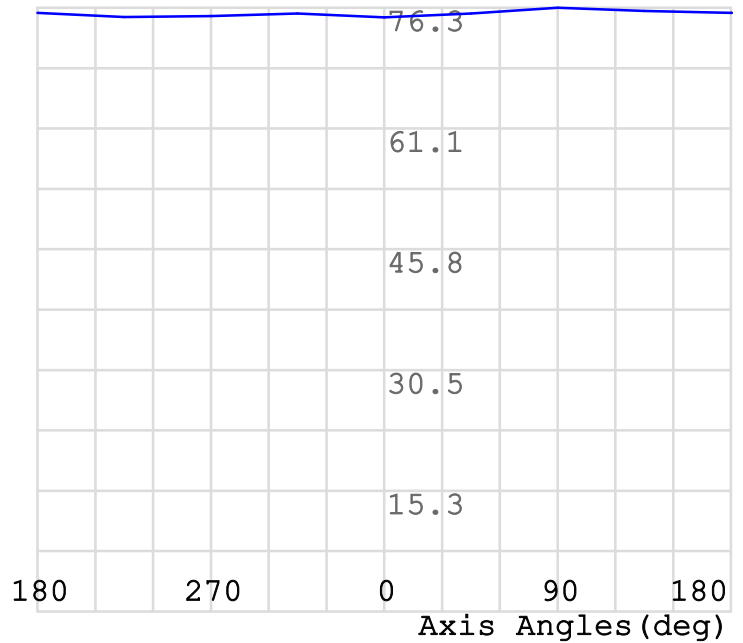
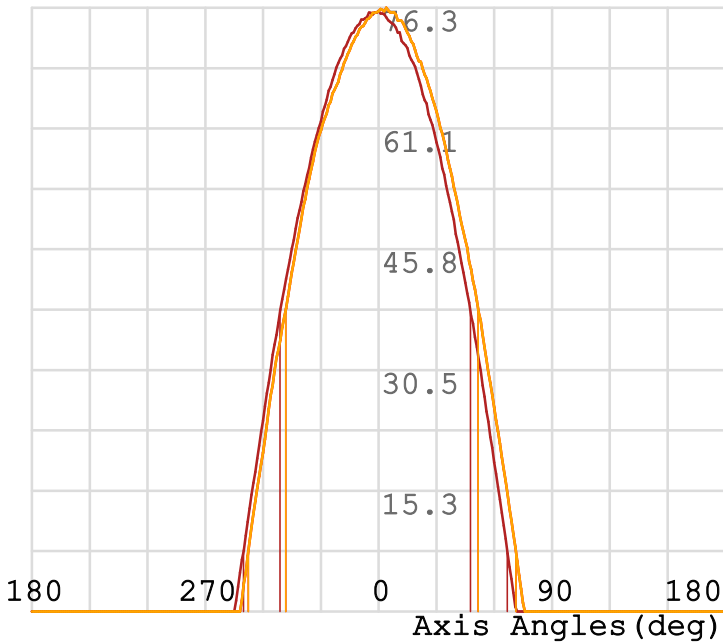
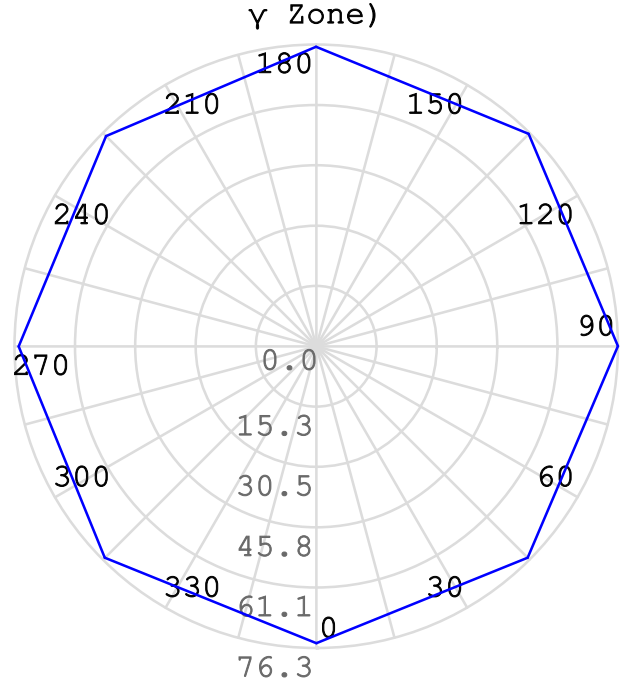
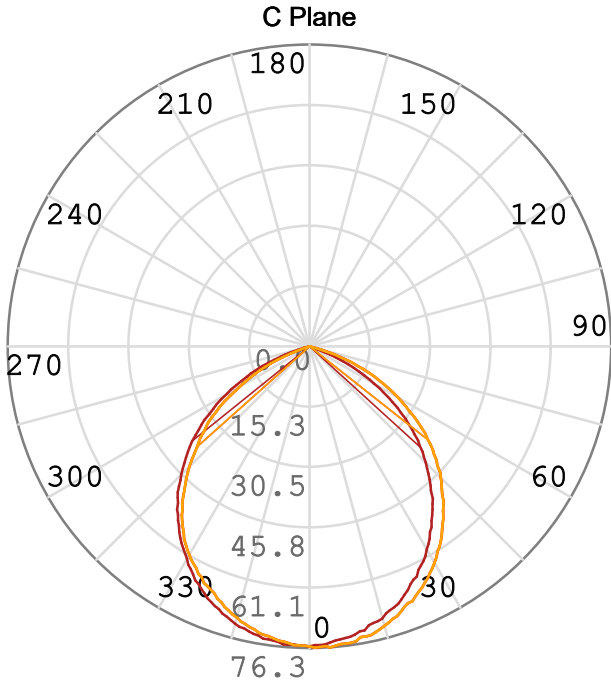

C Plane:	C90.0_270.0	— (red)	C0.0_180.0	— (brown)	C90.0_270.0	— (orange)
γ Cone:	γ4.0	— (blue)				

# IES Indoor Report

Photometric Filename: TT-2835-L1200-3000K-3-Milky LENS.IES

## 3D Light Intensity Distribution Curve

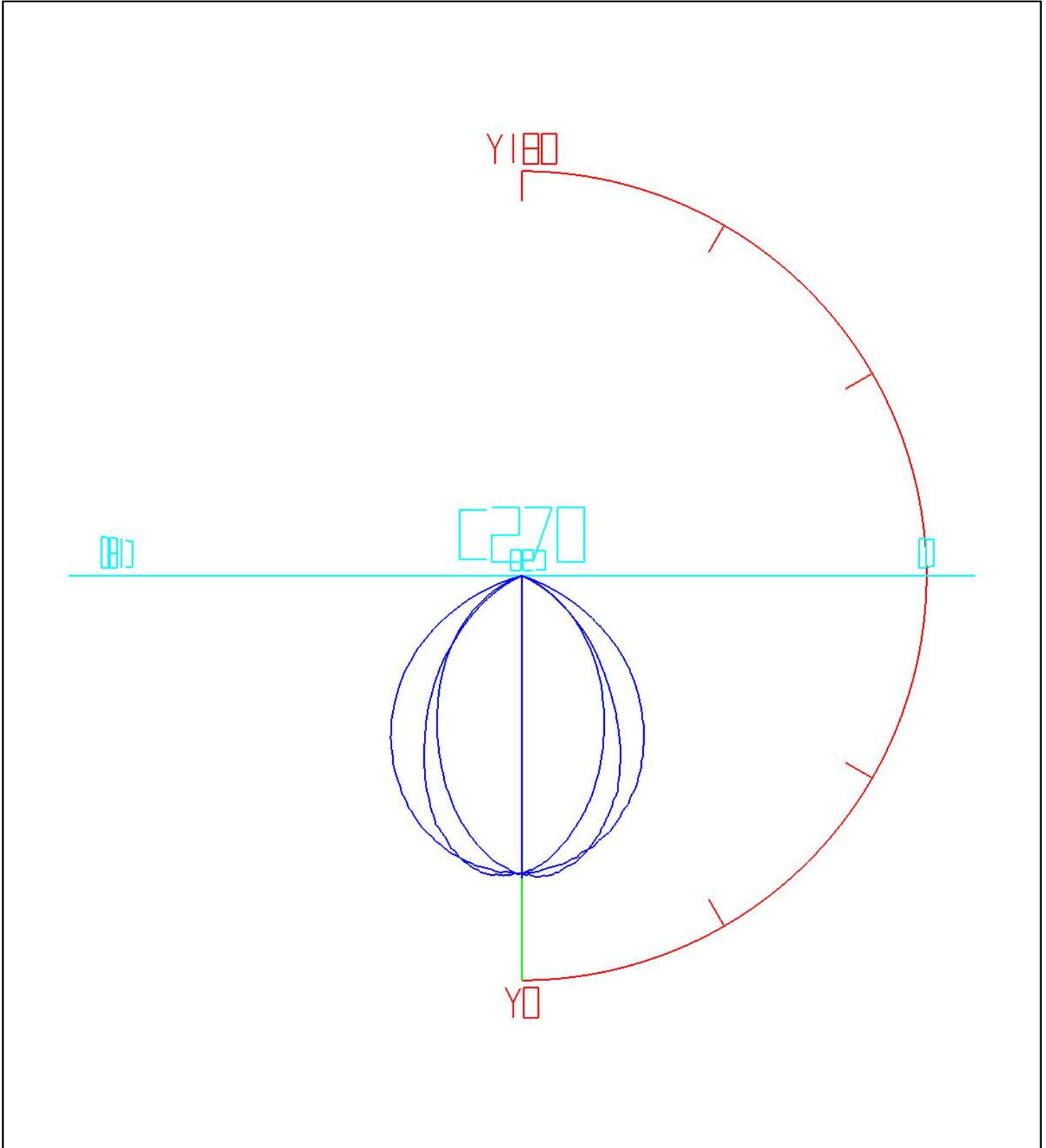

Curves: 3D Model ——— Fixture ——— Vert. HUD ——— Hori. HUD ———  
View Angles: Orient:0 Tilt:0 Roll:0 Spin:0

# IES Indoor Report

Photometric Filename: TT-2835-L1200-3000K-3-Milky LENS.IES

## Rectangle ISO Light Intensity Curve

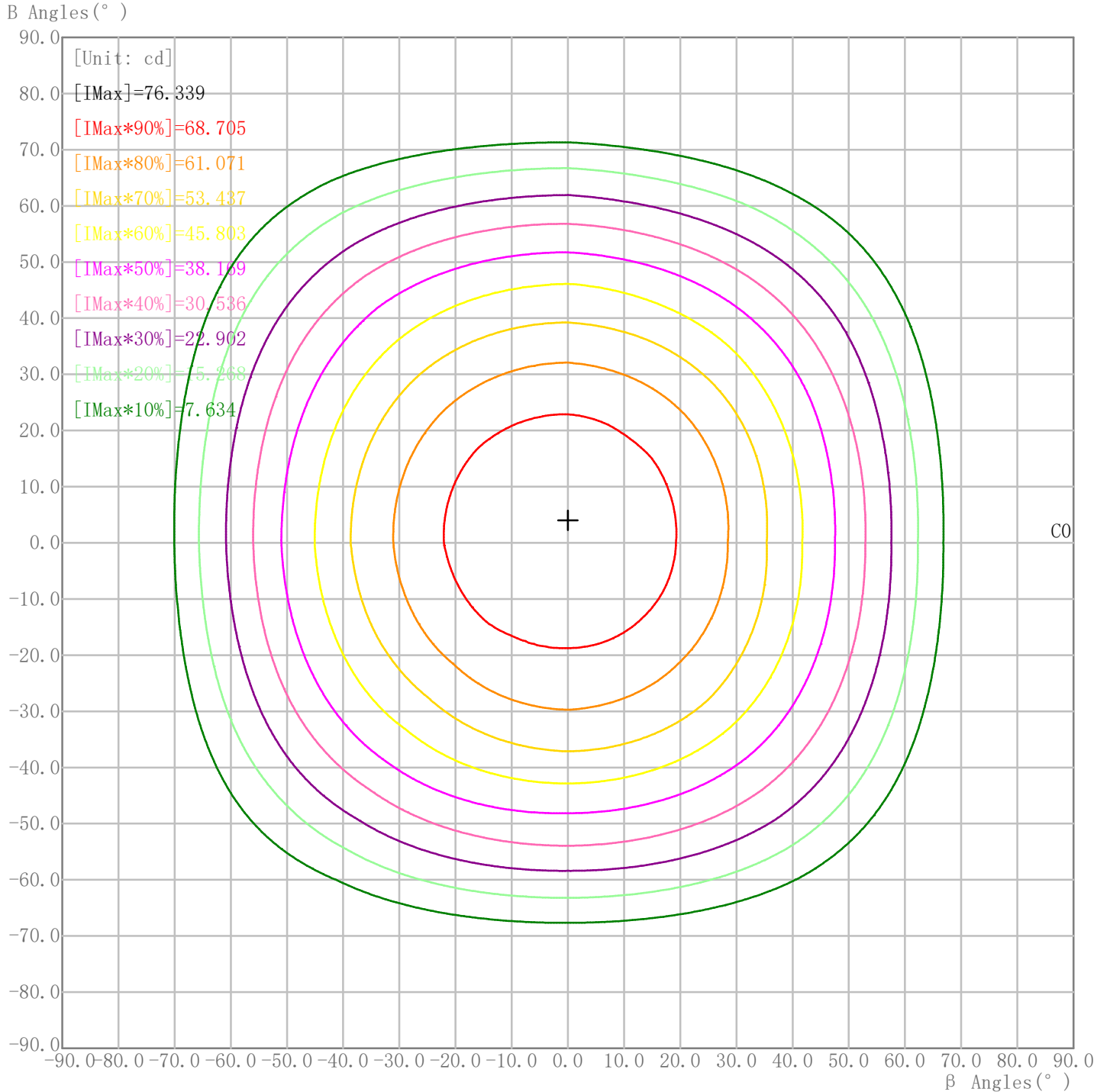

Curves: 90% — 80% — 70% — 60% — 50% — 40% — 30% — 20% — 10% —

Maximum Light Intensity(cd): 76.34 Maximum Cd. Angles: H0.0 V4.0

# IES Indoor Report

Photometric Filename: TT-2835-L1200-3000K-3-Milky LENS.IES

## Plane ISO-Illuminance Curve

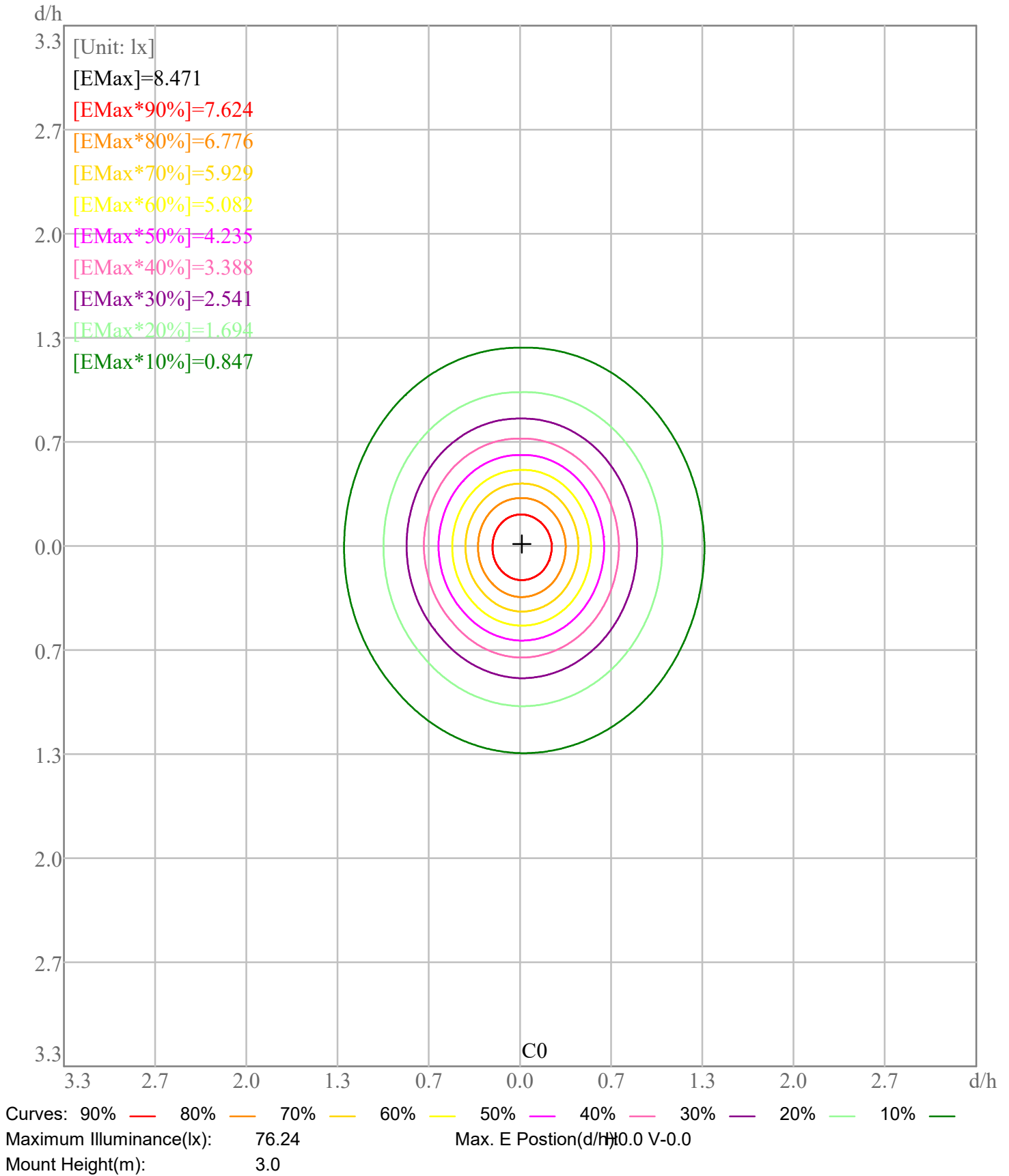

3D Plane ISO Illuminance Curve

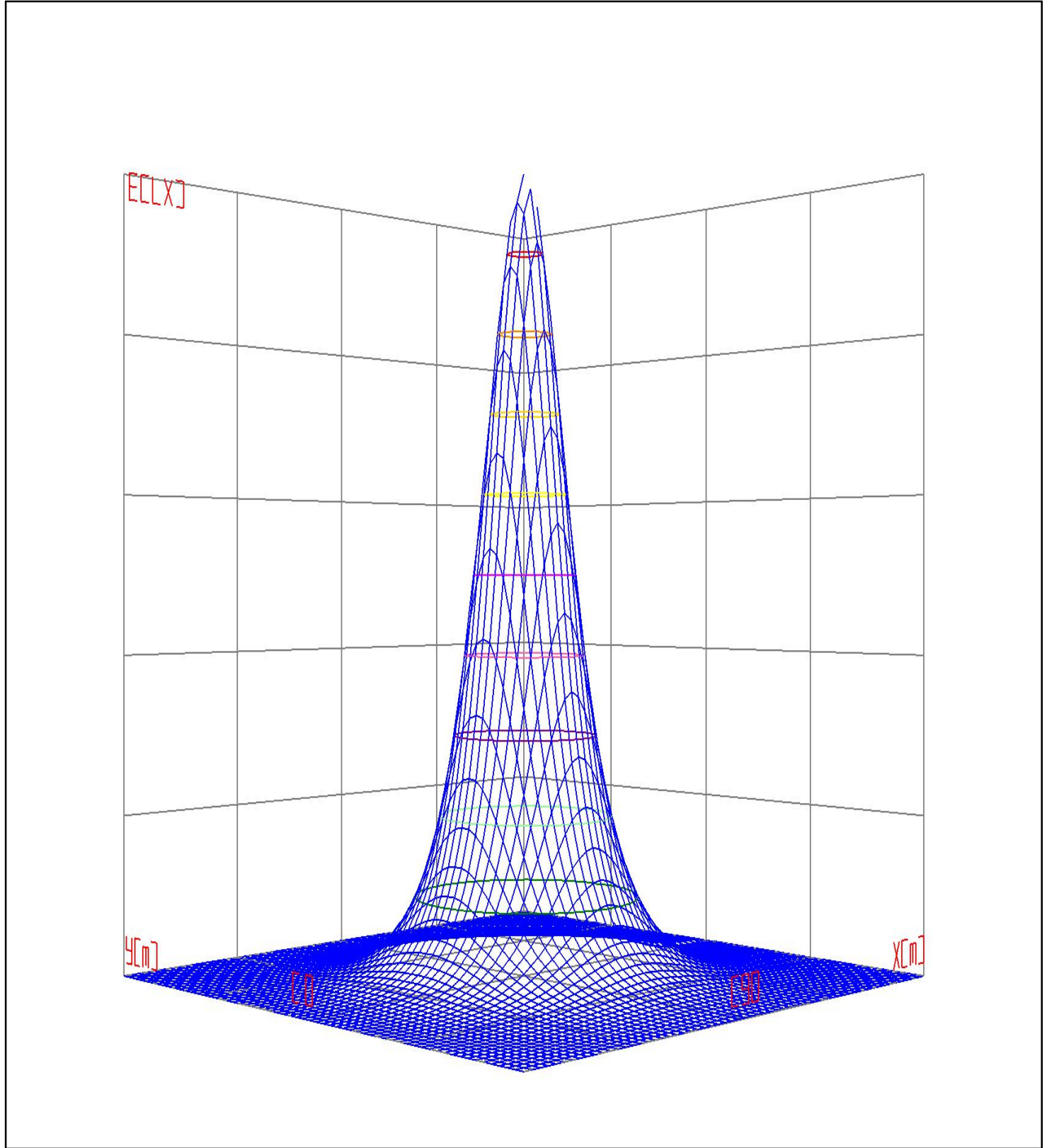

Curves: 3D Model — 90% — 80% — 70% — 60% — 50% — 40% — 30% — 20% — 10%  
View Angles(deg): 0      Height(m): 3.0      Distance(m): 10.0

# IES Indoor Report

Photometric Filename: TT-2835-L1200-3000K-3-Milky LENS.IES

## Space ISO Illuminance Curve

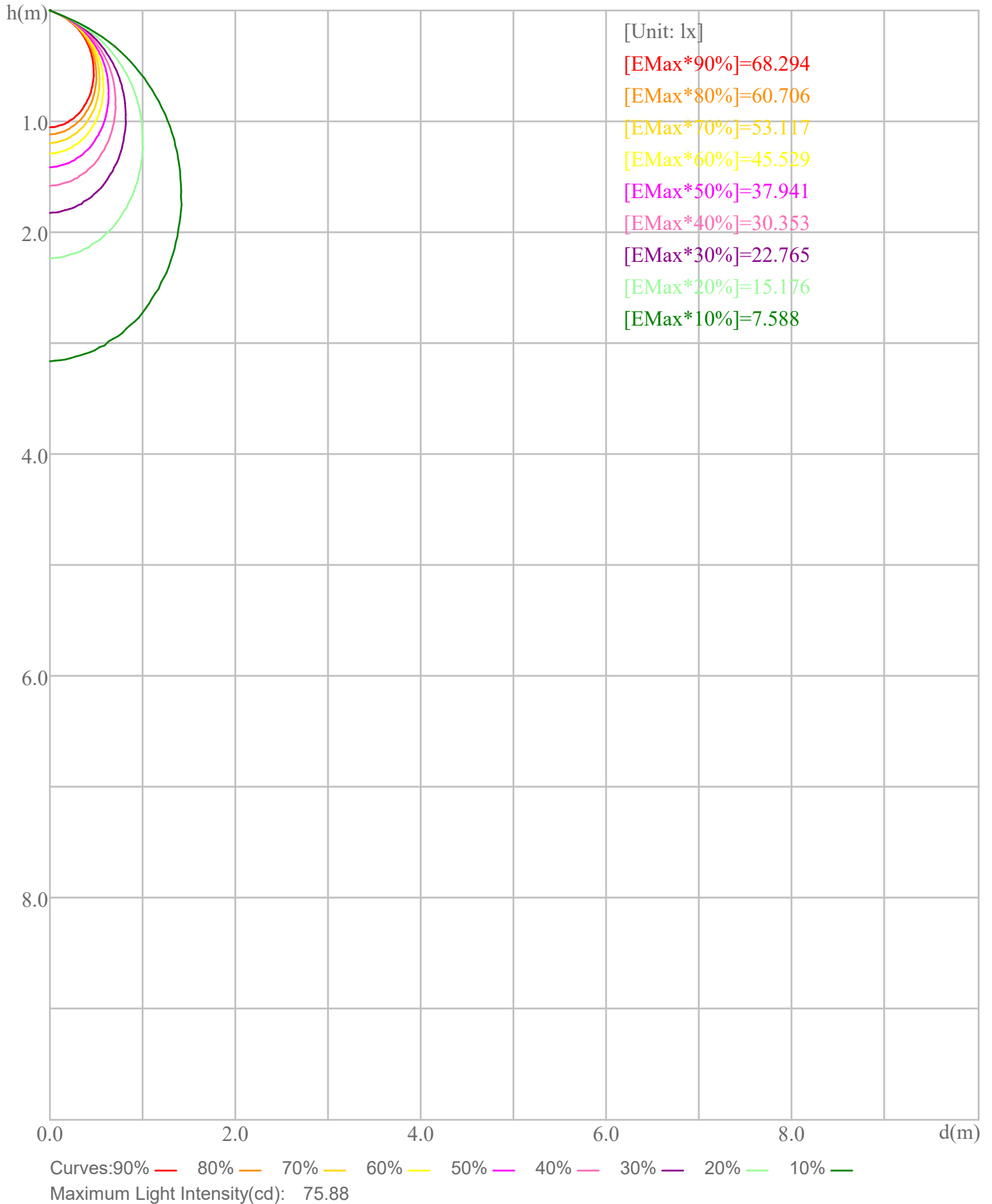



Illuminance-Distance Curve

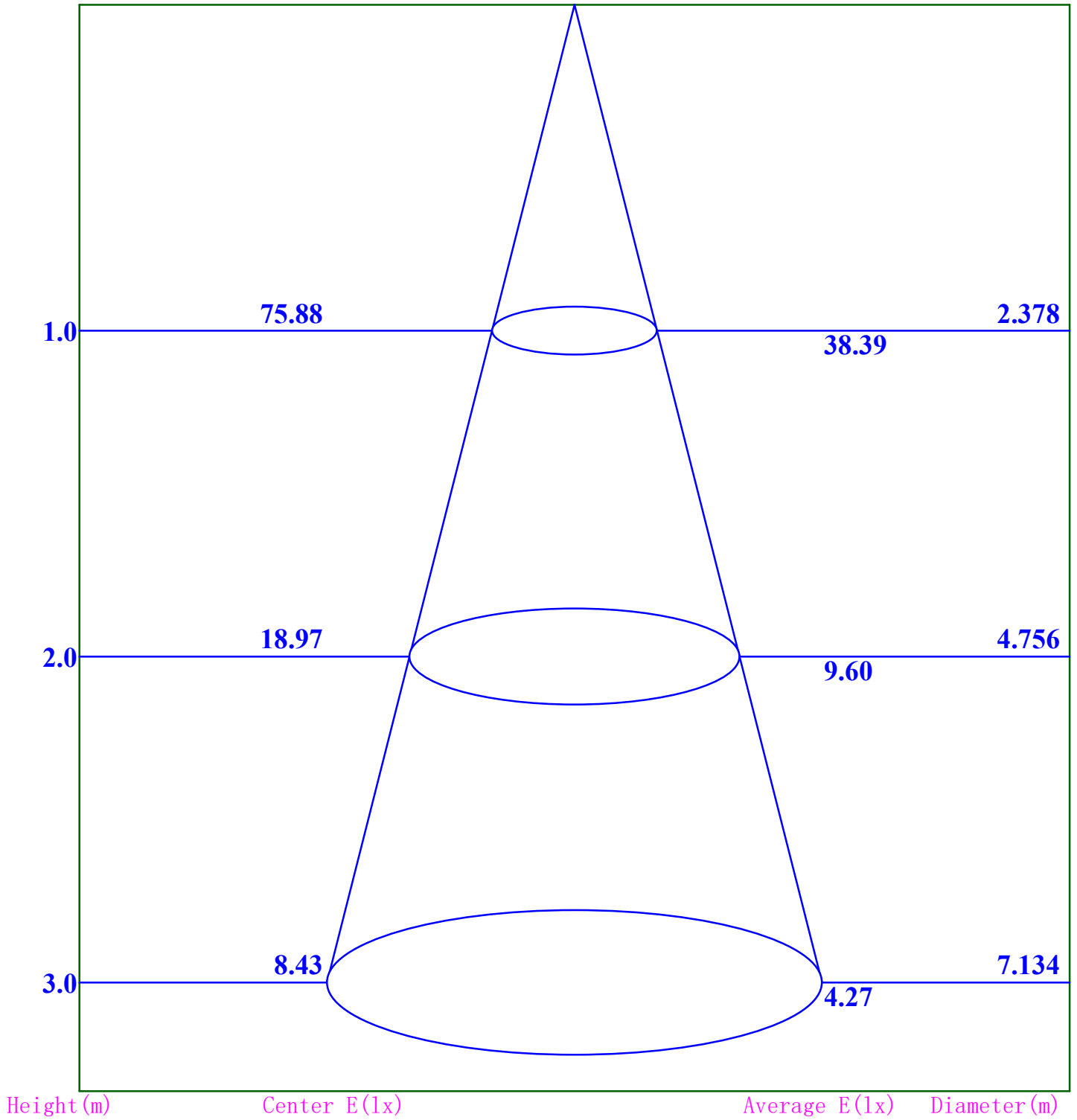

**Beam Angle:99.9**

# IES Indoor Report

Photometric Filename:TT-2835-L1200-3000K-3-Milky LENS.IES

## Indoor Luminance Limiting Curve

Glare Grade Table

GI	Quality	Using Illuminance							
		a	b	c	d	e	f	g	h
1.15	A	2000	1000	500	<=300				
1.5	B		2000	1000	500	<=300			
1.85	C			2000	1000	500	<=300		
2.2	D				2000	1000	500	<=300	
2.55	E					2000	1000	500	<=300
		a	b	c	d	e	f	g	h

Luminance Table

Gama(deg)	45	50	55	60	65	70	75	80	85
C0	1075	986	866	689	470	127	0	0	0
C90	1214	1159	1064	943	777	524	76	0	0

Luminance Limiting Curve

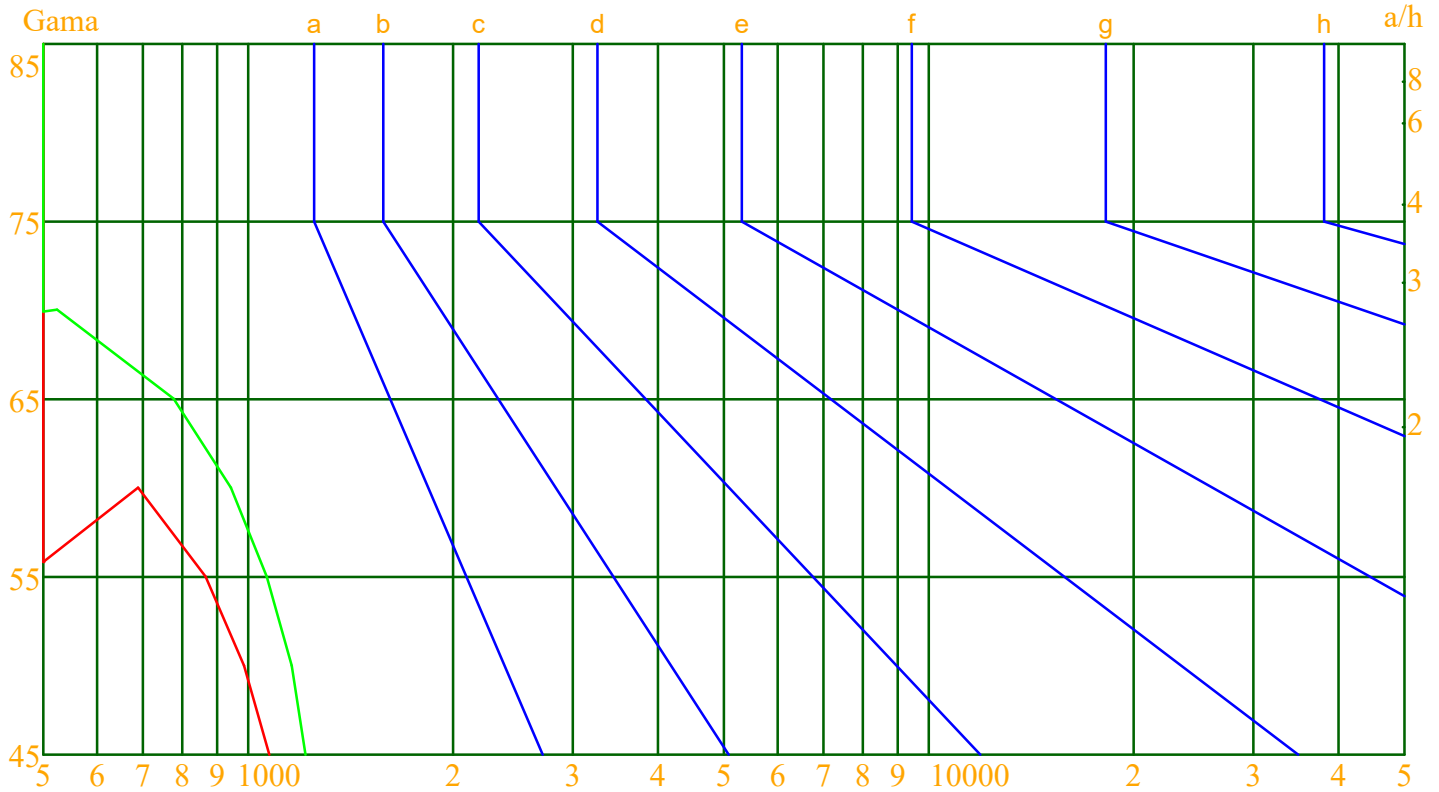

Luminous Size: Length(m)=0.304    Width(m)=0.120    Height(m)=0.060    Area(m<sup>2</sup>)=0.054720  
 Luminous Type: Without Luminous Side  
 Luminous Curves: C0-C180 Color: —    C90-C270 Color: —

# IES Indoor Report

Photometric Filename: TT-2835-L1200-3000K-3-Milky LENS.IES

## Indoor Budgetary Estimate Table

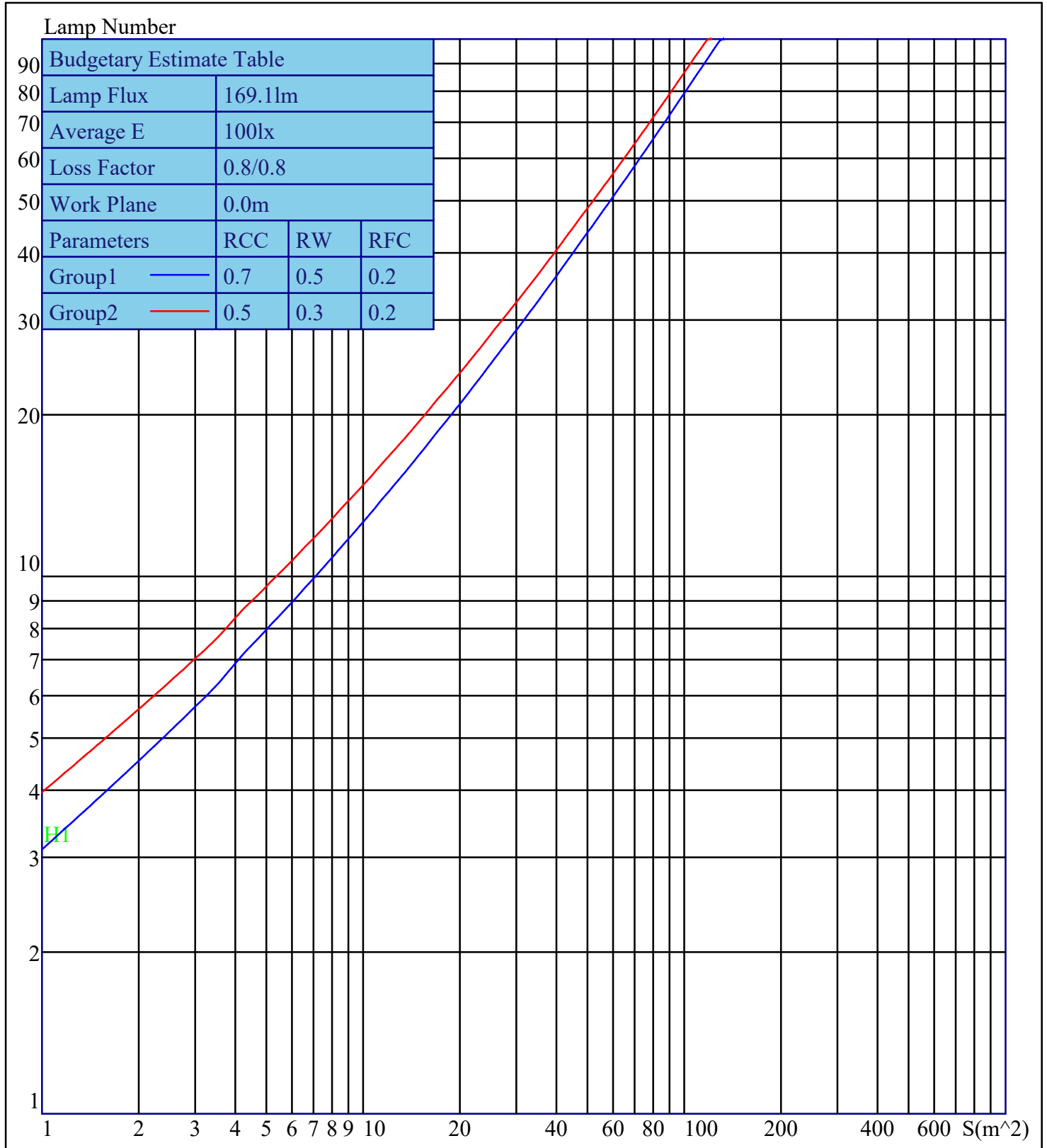

Parameters1: Rhocc = 0.7 Rhow = 0.5 Rhofc = 0.2 LLF = 0.8  
 Parameters2: Rhocc = 0.5 Rhow = 0.3 Rhofc = 0.2 LLF = 0.8  
 Average Illuminance(lx): 100 Cavity Height: H1(m) = 2