

TITANIUM

TECHNOLOGY

TT-2835-L1200

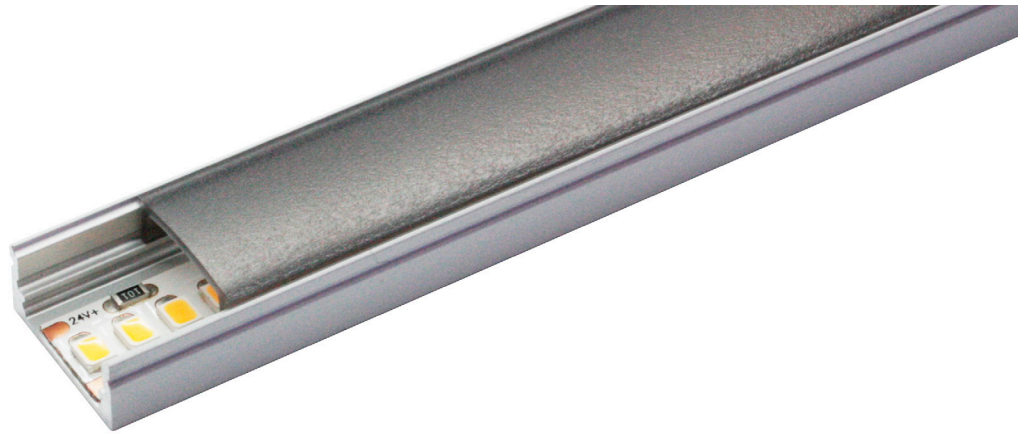

- 5m roll of SMD2835 LED Strip in 5 meter roll.

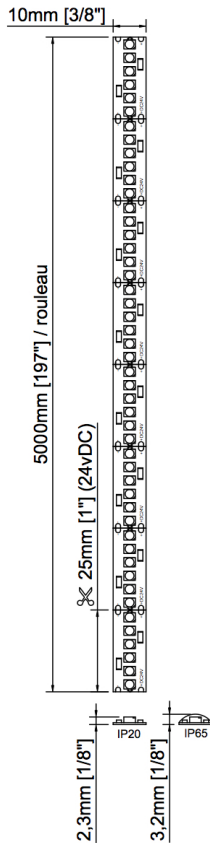

Voltage	24vDC	
LED/m	240 / m	
Power	30,4 w / m 9,26 w / feet 152 w / roll	
Amperage	1,27 A / m 0,39 A / feet 6,34 A / roll	
Lumen	27K - 448 lm / feet 30K - 456 lm / feet 35K - 452 lm / feet 40K - 422 lm / feet 60K - 384 lm / feet	- 55 lm / w - 64 lm / w 57 lm / w
Angle	120°	
Size	IP20	10mm x 2,3mm x 5000mm 3/8" x 1/8" x 196 7/8"
	IP65	10mm x 3,2mm x 5000mm 3/8" x 1/8" x 196 7/8"
	IP67	13mm x 5mm x 5000mm 1/2" x 3/16" x 196 7/8"
Cut line	25 mm 1"	
Finish	White	
Dimmable	Yes	
LED Colour	27K - Warm white 2700K 30K - Warm white 3000K 35K - Neutral white 3500K 40K - Neutral white 4000K 60K - Cold white 6000K R - Red G - Green B - Blue A - Amber	
Working temp.	-40°C ~ 70°C	
IP	20, 65, 67	

PRODUCT COLOR

TT	SMD	LED PER ROLL	IP	LED COLOR	VOLTAGE
TT	2835	L1200	20	27K	24V
TT	2835	L1200			24V

IES Indoor Report

Photometric Filename:TT-2835-L1200-3000K-5-Smoke LENS.IES

Indoor Luminaire Photometric Data

Description Information

Luminaire Name: TT-2835-L1200-3000k-5-Smoke-lens	Luminaire Catalog:	Test ID:
Lamp Name: TT-2835-L1200-3000k-5-Smoke-lens	Lamp Catalog: 2835	Test Date: 2021/03/23
Manufacture: TITANIUM TECHNOLOGIE	ShieldingAngle(°):	Test Machine: GON-2000
Test Lab:	Frequency(Hz):	Luminaire CCT(K):
Luminaire Size(W*L*H): 0.120*0.304*0.060	Lighting Area(m2): 0.055	Luminaire Weight(kg): 0.100
Test System: C, γ	Test Step: C=45.0 γ =1.0	Temperature(°C): 25
		Humidity(%):

Character Parameter

Lamp Speciality Parameter	
Lamp Rated Lumens(lm): 448.000	Lamp Number in Luminaire: 1
Lamp Norminal Power(W):	Lamp Rated Voltage(V):
Lamp Tested Power(W): 8.312	Lamp Tested Voltage(V): 23.7
Lamp Tested Current(A): 0.350	Lamp Tested PF:
Lamp Size(W*L*H): 0.120*0.304*0.060	
Luminaire Speciality	
Luminaire Lumens(lm): 89.742	Beam Angle(10%Imax): 73.6
Luminaire Efficiency: 20.03%	Left=-35.5 Right=38.1
Luminaire EER(lm/W): 10.797	Field Angle(10%Imax): 111.9
Muximum Cand.(cd): 67.922	Spacing Criteria S/MH(C0_180): 0.983
Max Cd. Angle(°): C=135.0 γ =4.0	Spacing Criteria S/MH(C90_270): 1.017
Downward Lumens(lm): 89.742	CIE Type: Semi-Direct
Upward Lumens(lm): 0.000	ErP ϕ use(90deg): 77.161lm
Downward Total Efficiency%: 100.00	IRF(%): 172.031
Upward Total Efficiency%: 0.00	

IES Indoor Report

Photometric Filename: TT-2835-L1200-3000K-5-Smoke LENS.IES

2D Light Intensity Distribution Curve

Plane [50%Ang.] [10%Ang.]

C135.0: 73.6 111.9

C0.0: 70.5 108.1

C90.0: 73.8 112.4

Polar Graph

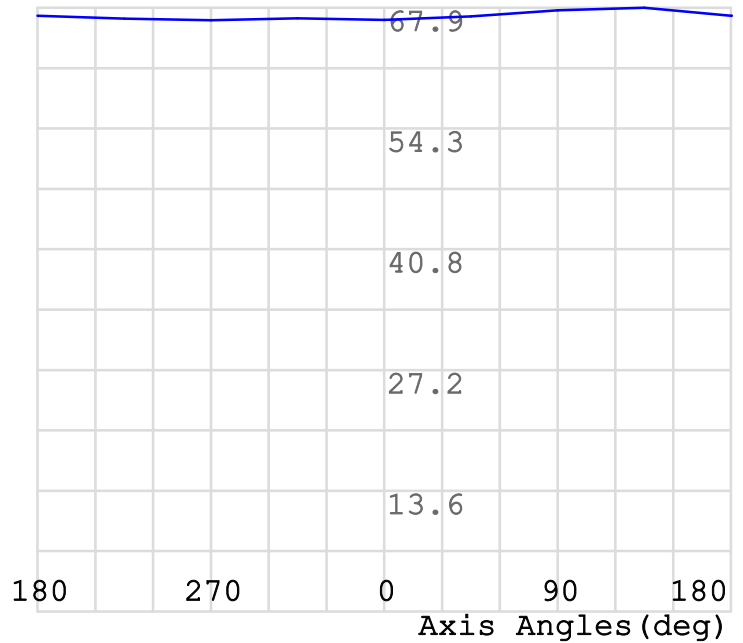
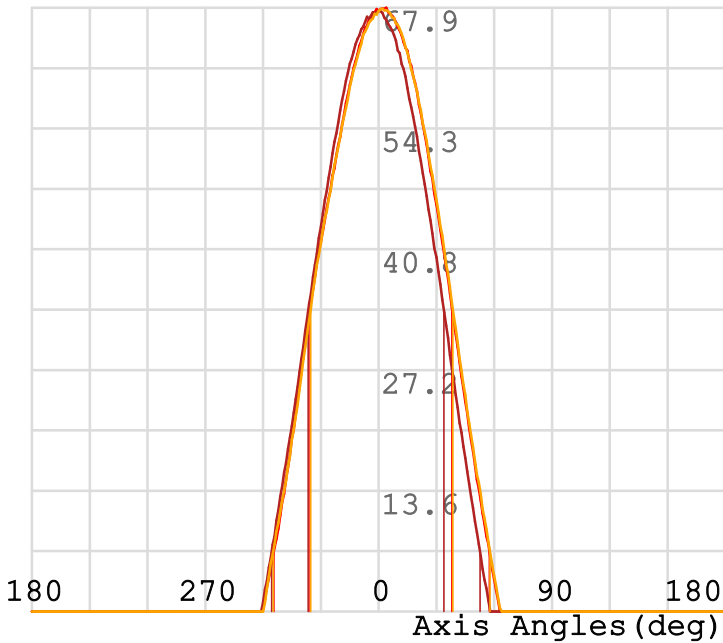
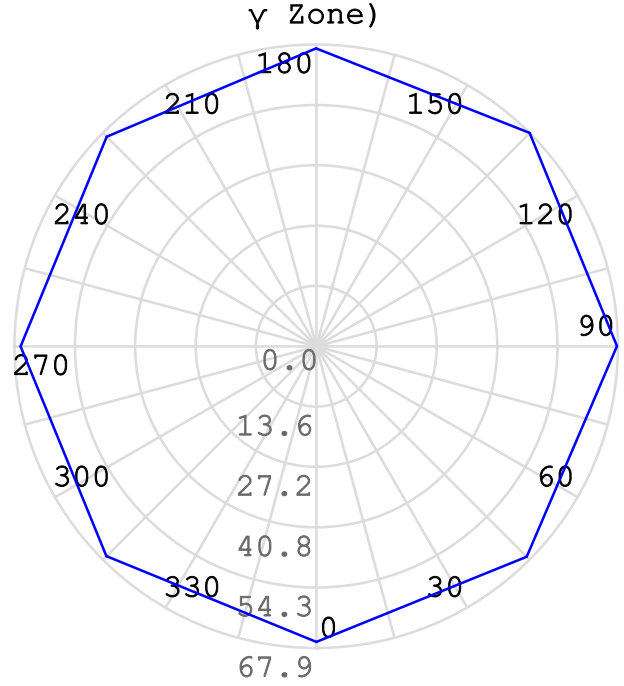
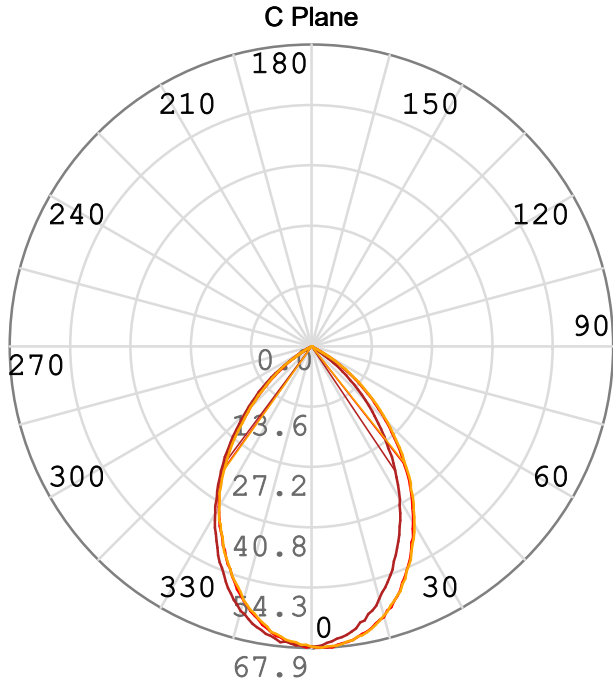

C Plane: C135.0_315.0 ——— C0.0_180.0 ———

γ Cone: γ4.0 ———

C90.0_270.0 ———

IES Indoor Report

Photometric Filename:TT-2835-L1200-3000K-5-Smoke LENS.IES

3D Light Intensity Distribution Curve

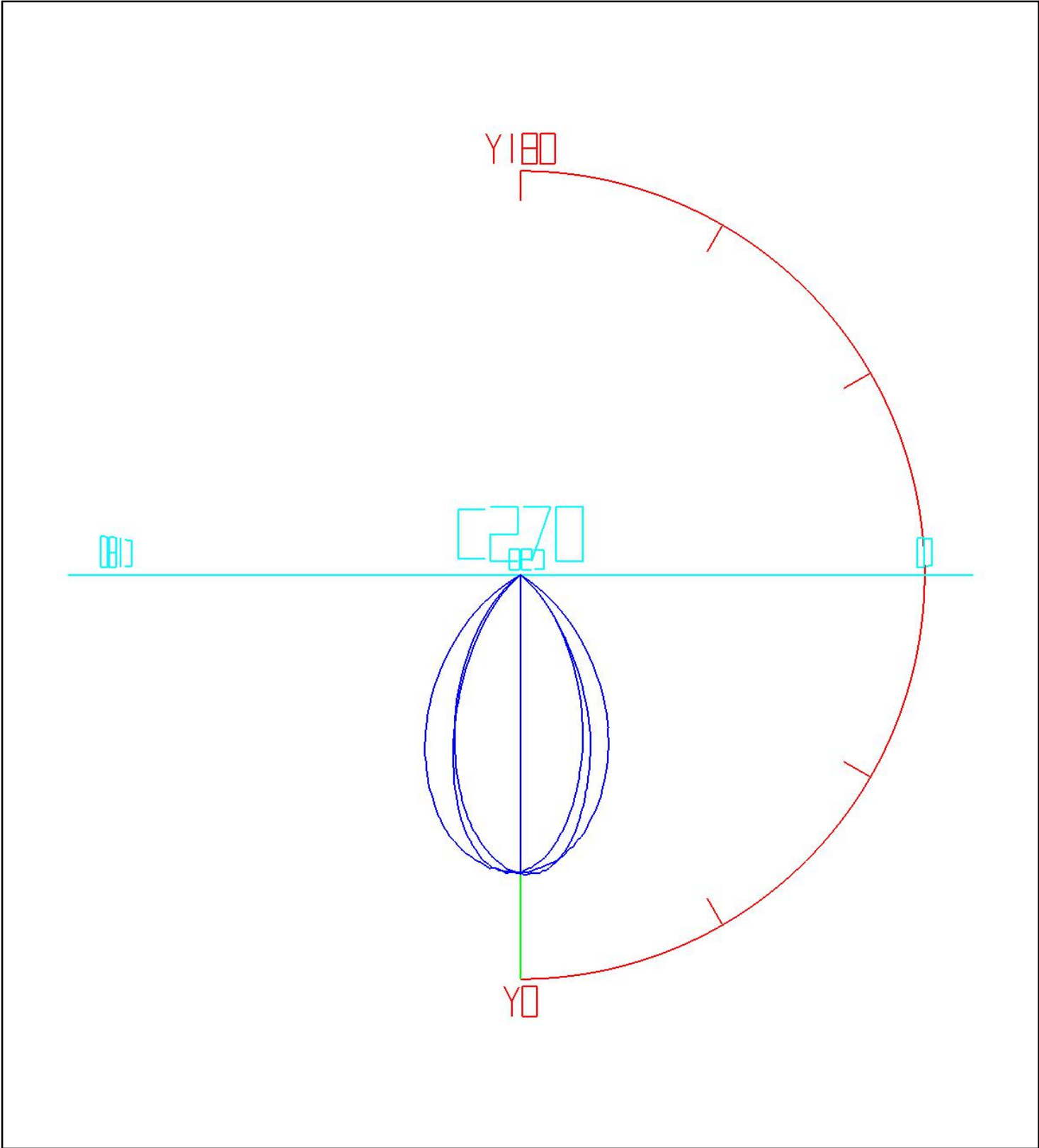

Curves: 3D Model ——— Fixture ——— Vert. HUD ——— Hori. HUD ———
View Angles: Orient:0 Tilt:0 Roll:0 Spin:0

IES Indoor Report

Photometric Filename: TT-2835-L1200-3000K-5-Smoke LENS.IES

Rectangle ISO Light Intensity Curve

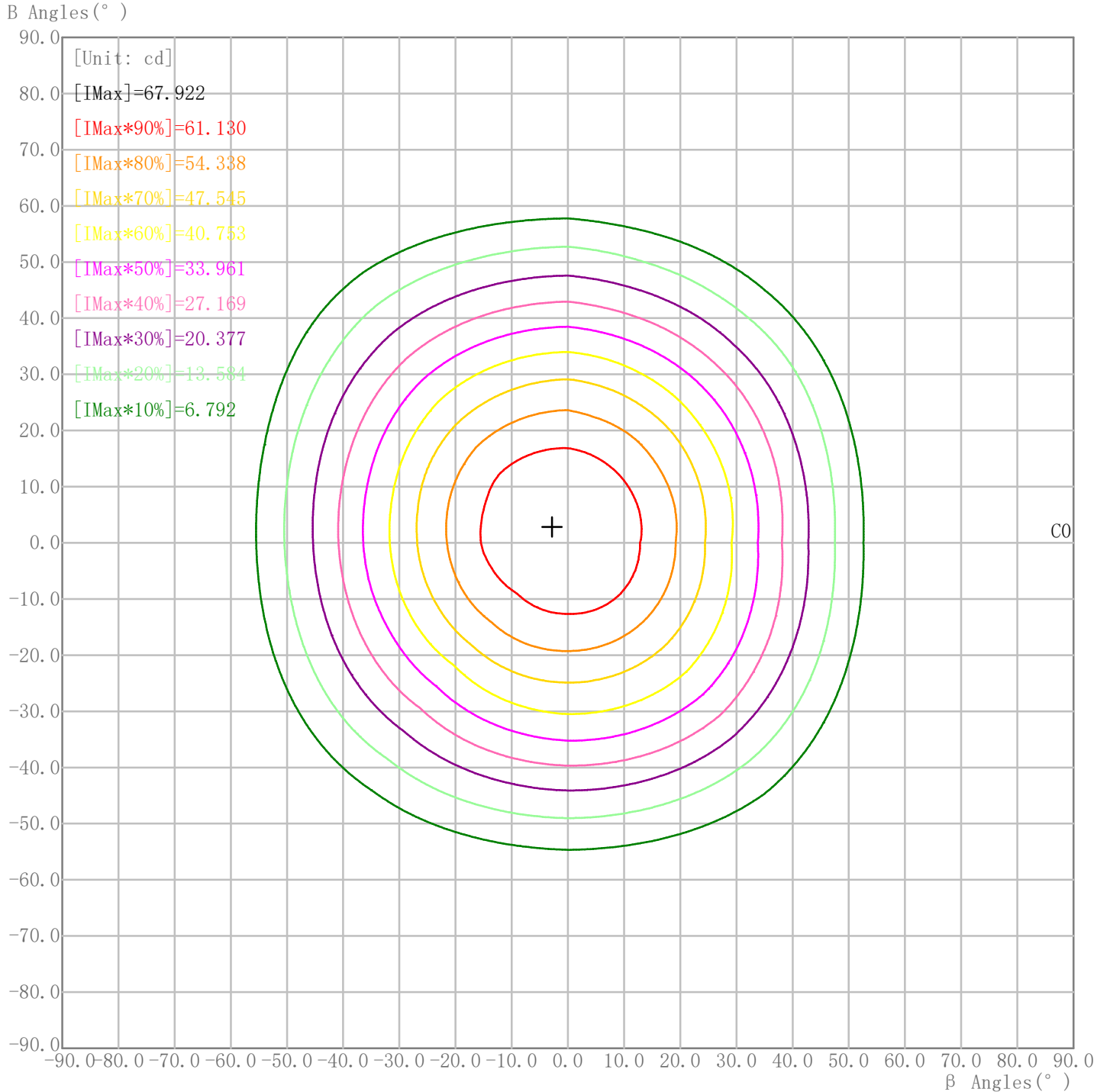

Curves: 90% — 80% — 70% — 60% — 50% — 40% — 30% — 20% — 10% —

Maximum Light Intensity(cd): 67.92

Maximum Cd. Angles: H-2.8 V2.8

IES Indoor Report

Photometric Filename: TT-2835-L1200-3000K-5-Smoke LENS.IES

Plane ISO-Illuminance Curve

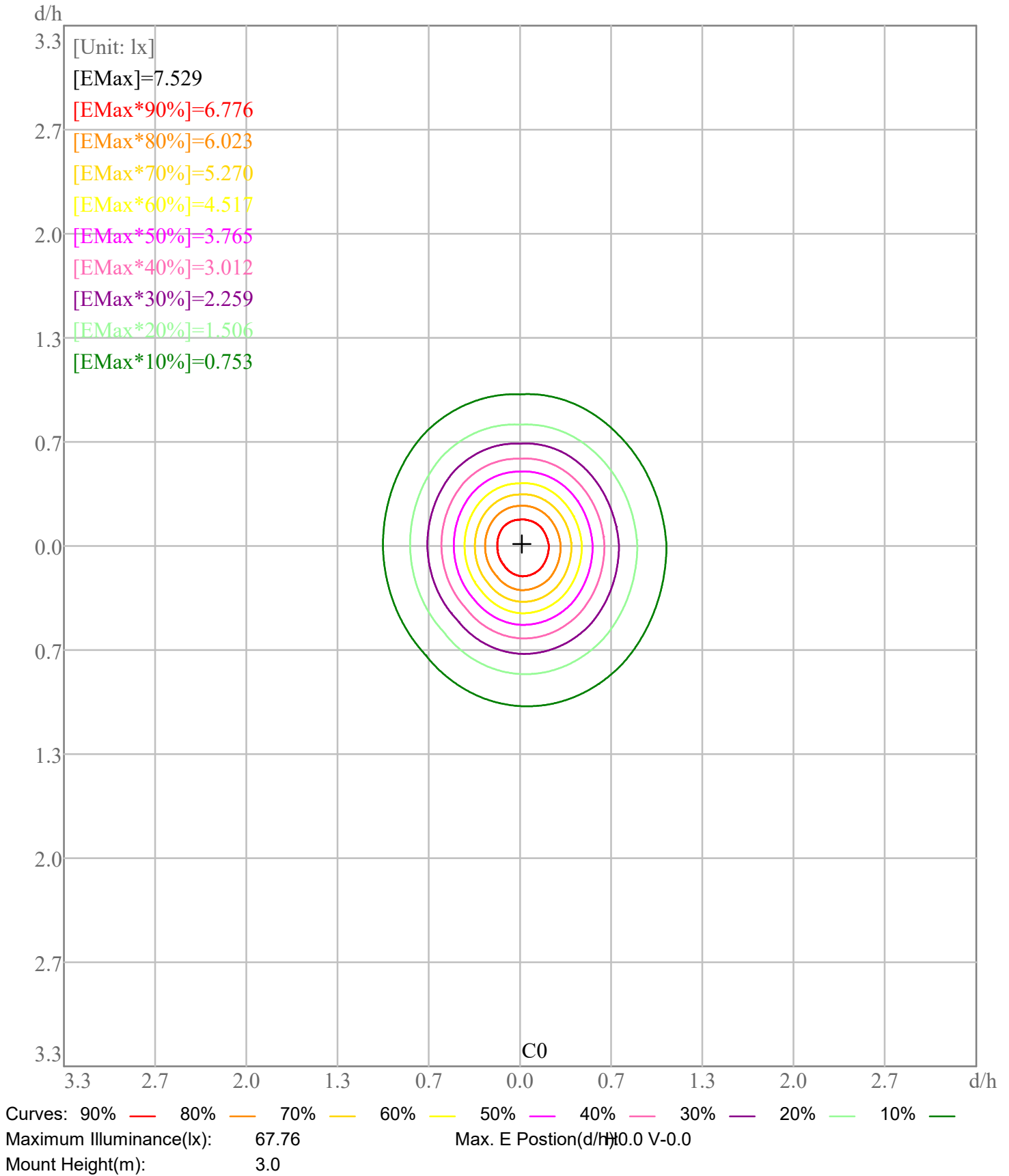

3D Plane ISO Illuminance Curve

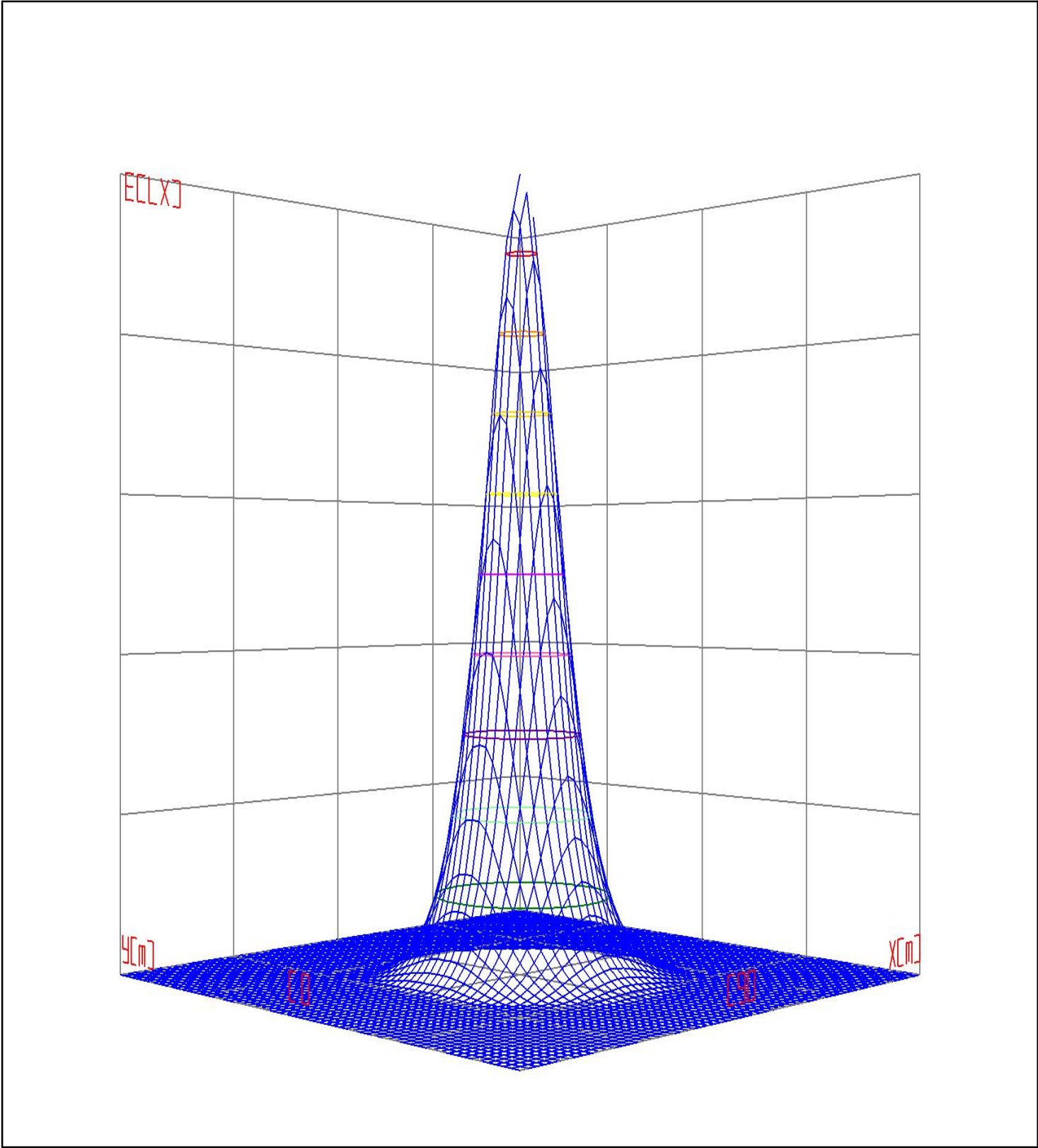

Curves: 3D Model — 90% — 80% — 70% — 60% — 50% — 40% — 30% — 20% — 10%
View Angles(deg): 0 Height(m): 3.0 Distance(m): 10.0

IES Indoor Report

Photometric Filename: TT-2835-L1200-3000K-5-Smoke LENS.IES

Space ISO Illuminance Curve

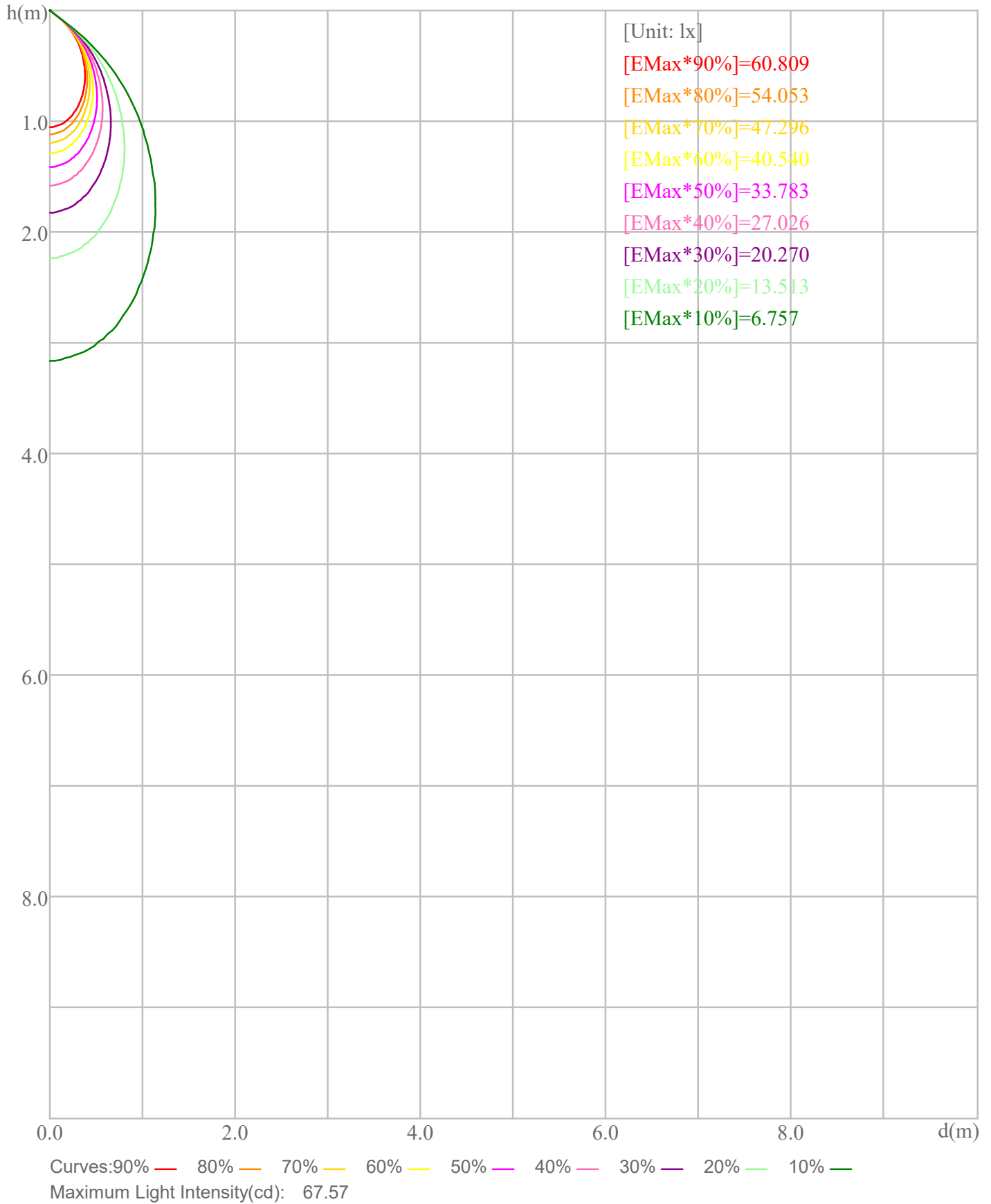

Illuminance-Distance Curve

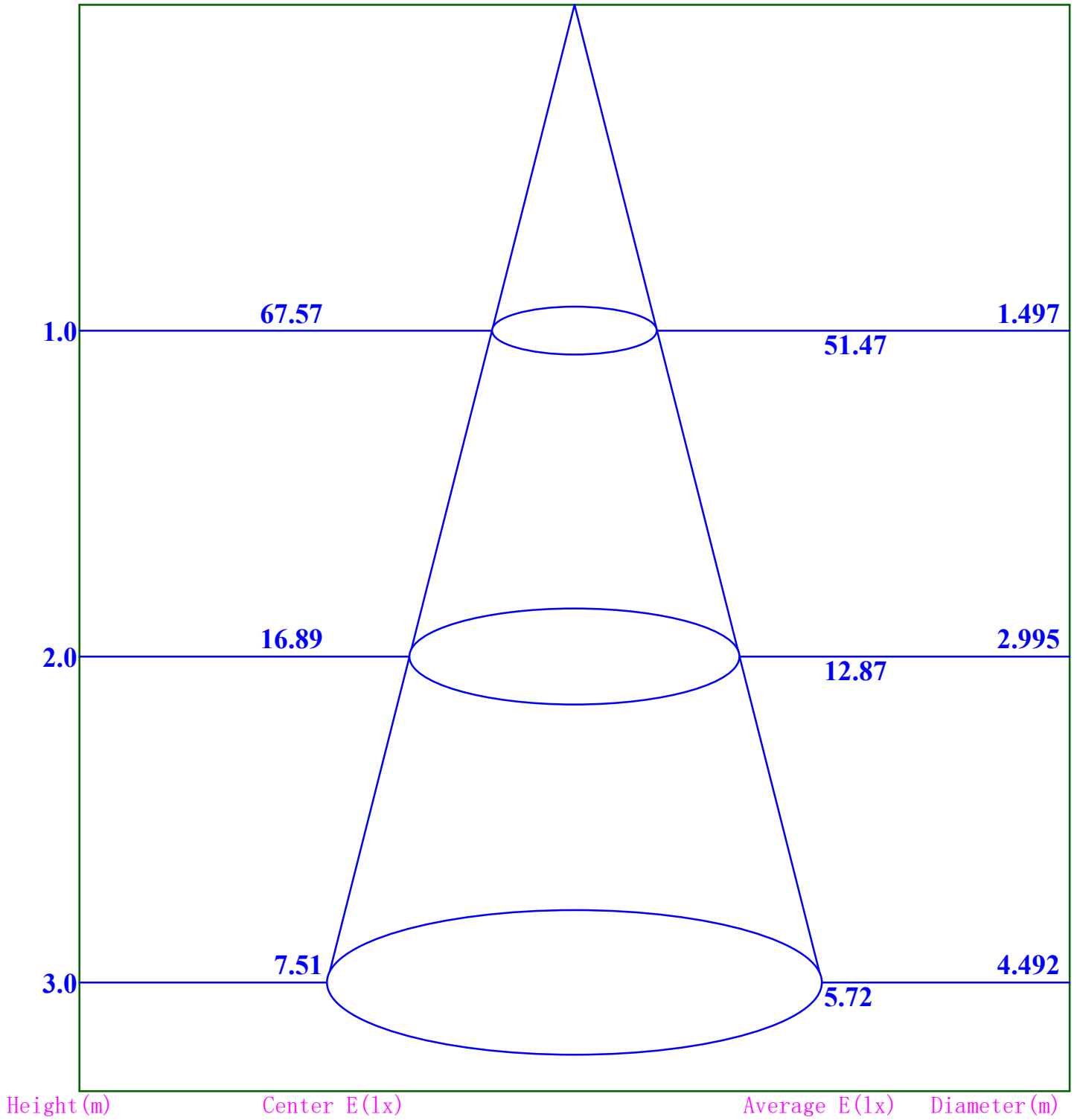

Beam Angle:73.6

IES Indoor Report

Photometric Filename:TT-2835-L1200-3000K-5-Smoke LENS.IES

Indoor Luminance Limiting Curve

Glare Grade Table

GI	Quality	Using Illuminance							
		a	b	c	d	e	f	g	h
1.15	A	2000	1000	500	<=300				
1.5	B		2000	1000	500	<=300			
1.85	C			2000	1000	500	<=300		
2.2	D				2000	1000	500	<=300	
2.55	E					2000	1000	500	<=300
		a	b	c	d	e	f	g	h

Luminance Table

Gama(deg)	45	50	55	60	65	70	75	80	85
C0	446	289	112	0	0	0	0	0	0
C90	629	482	333	146	0	0	0	0	0

Luminance Limiting Curve

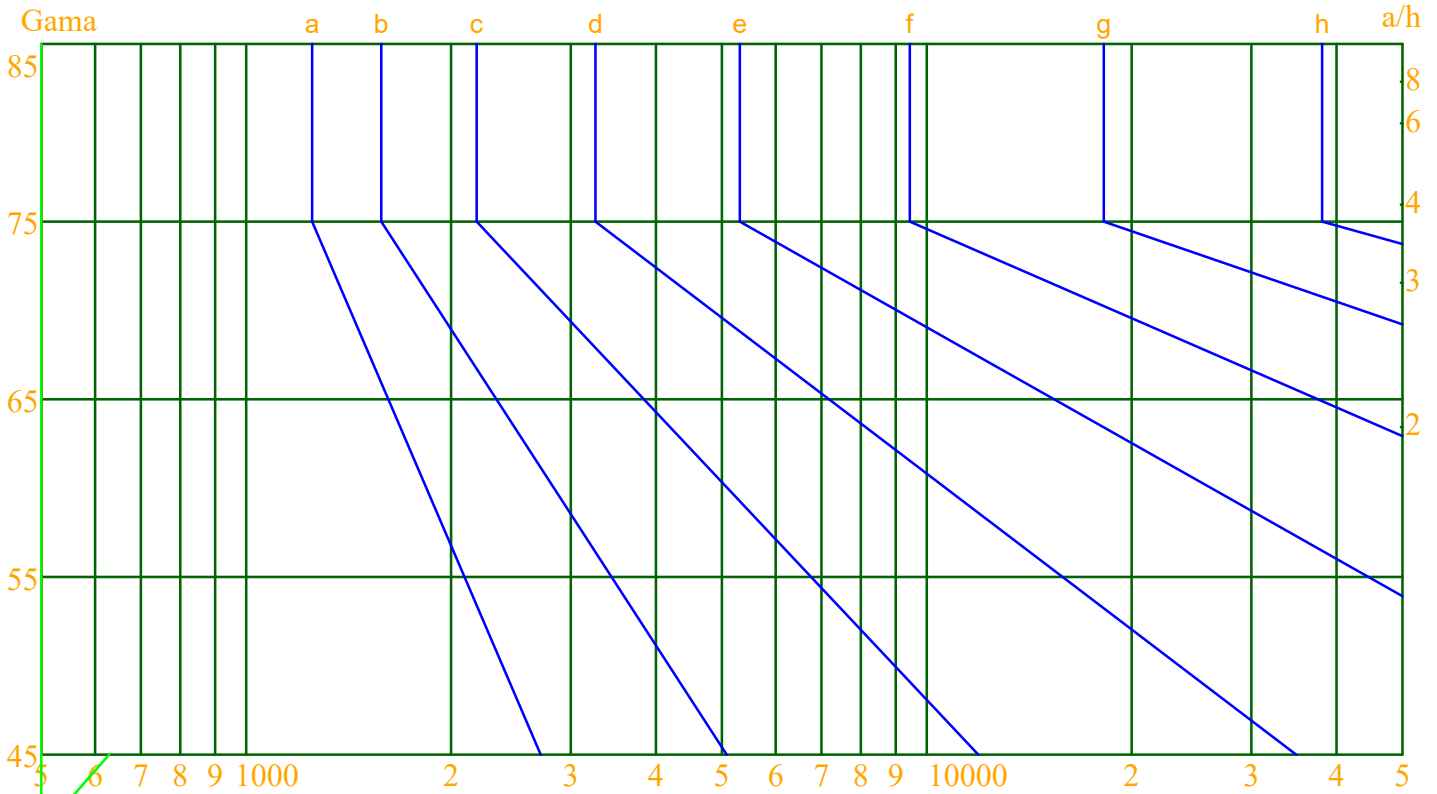

Luminous Size: Length(m)=0.304 Width(m)=0.120 Height(m)=0.060 Area(m^2)=0.054720
 Luminous Type: Without Luminous Side
 Luminous Curves: C0-C180 Color: — C90-C270 Color: —

IES Indoor Report

Photometric Filename: TT-2835-L1200-3000K-5-Smoke LENS.IES

Indoor Budgetary Estimate Table

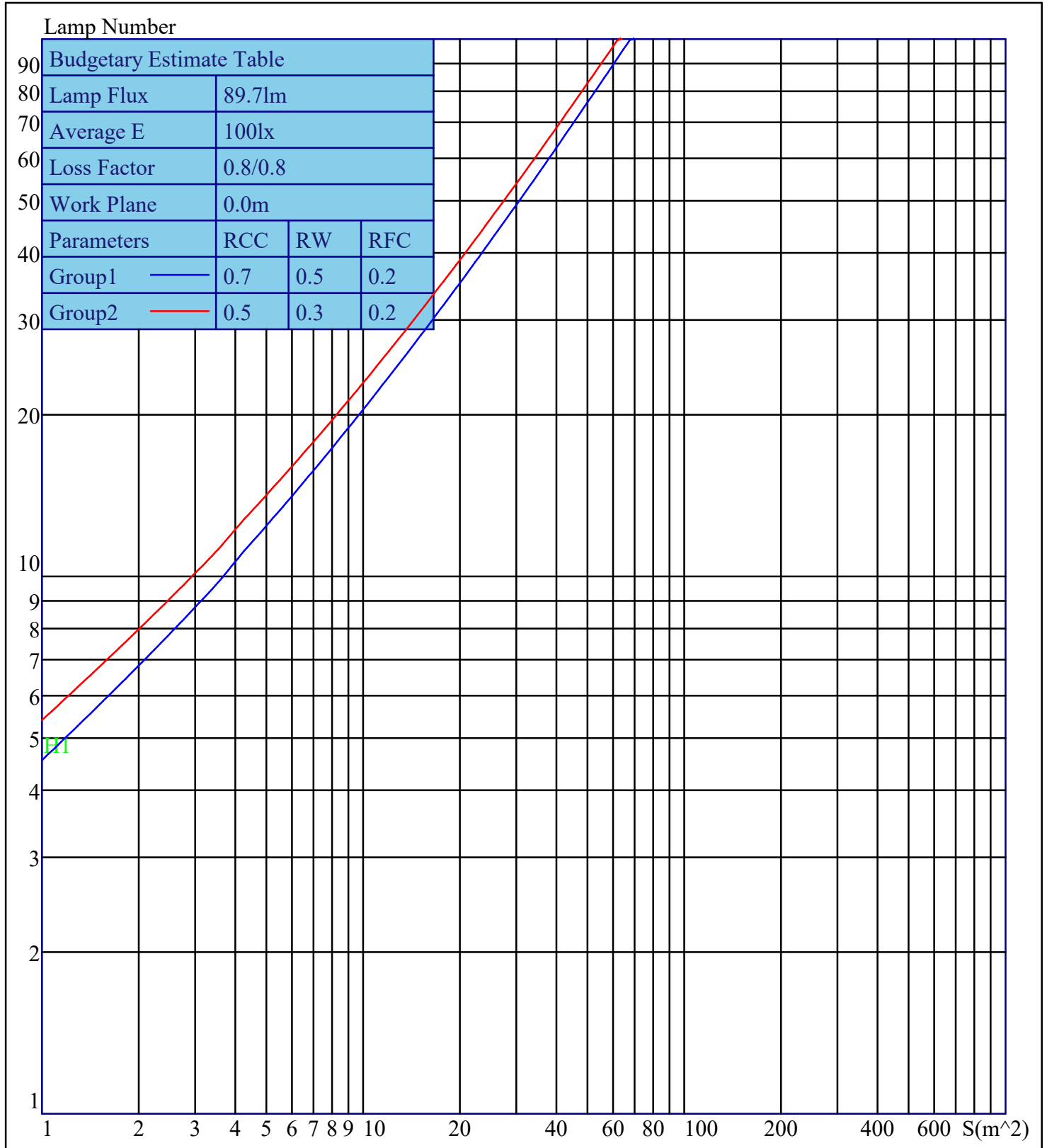

Parameters1: Rhocc = 0.7 Rhow = 0.5 Rhofc = 0.2 LLF = 0.8
 Parameters2: Rhocc = 0.5 Rhow = 0.3 Rhofc = 0.2 LLF = 0.8
 Average Illuminance(lx): 100 Cavity Height: H1(m) = 2