

TITANIUM

TECHNOLOGY

TT-2835-L600

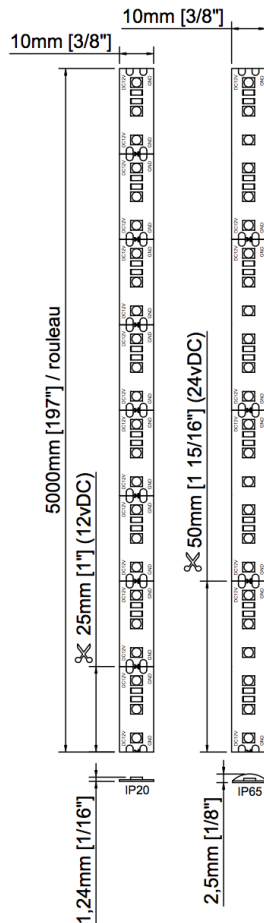
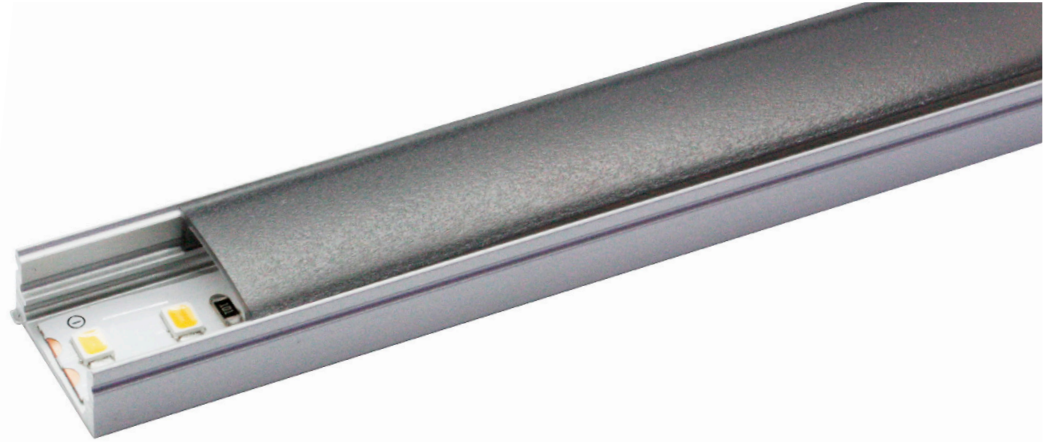

Voltage	12vDC	24vDC
LED/m	120 / m	
Power	16,4w / m 5w / feet 82w / roll	
Amperage	1,37A / m 0,42A / feet 6,84A / roll	0,69A / m 0,21A / feet 3,42A / roll
Lumen	27K - 243 lm/ feet 30K - 221 lm/ feet 35K - 246 lm/ feet 40K - 218 lm/ feet 60K - 245 lm/ feet	61 lm/ w 49 lm/ w 57 lm/ w 51 lm/ w -
CRI (RA)	90	
Angle	120°	
Size	IP20	10mm x 1,25mm x 5000mm 3/8" x 1/16" x 1967/8"
	IP65	10mm x 2,5mm x 5000mm 3/8" x 1/8" x 1967/8"
	IP67	13mm x 5mm x 5000mm 1/2" x 3/16" x 1967/8"
Cut line	25 mm 1"	50 mm 2"
Finish	White	
Dimmable	Yes	
LED Colour	27K - Warm white 2700K 30K - Warm white 3000K 35K - Neutral white 3500K 40K - Neutral white 4000K 60K - Cold white 6000K R - Red G - Green B - Blue CB - Crystal Blue A - Amber O - Orange P - Pink UV - UV 395~400nm RGB - Color mixing 3:1	
Working temp.	-40°C ~ 70°C	
IP	20, 65, 67	

PRODUCT CODE

TT	SMD	LED PER ROLL	IP	LED COLOR	VOLTAGE
TT	2835	L600	20	27K	24V
TT	2835	L600			

IES Indoor Report

Photometric Filename:TT-2835-L600-2700K-5-Smoke LENS.IES

Indoor Luminaire Photometric Data

Description Information

Luminaire Name: TT-2835-L600-2700k-5-Smoke-lens		Luminaire Catalog:	Test ID:
Lamp Name: TT-2835-L600-2700k-5-Smoke-lens		Lamp Catalog: 2835	Test Date: 2021/03/19
Manufacture: TITANIUM TECHNOLOGIE		ShieldingAngle(°):	Test Machine: GON-2000
Test Lab:		Frequency(Hz):	Luminaire CCT(K):
Luminaire Size(W*L*H): 0.120*0.304*0.060		Lighting Area(m2): 0.055	Luminaire Weight(kg): 0.100
Test System: C, γ	Test Step: C=45.0 γ =1.0	Temperature(°C): 25	Humidity(%):

Character Parameter

Lamp Speciality Parameter	
Lamp Rated Lumens(lm): 448.000	Lamp Number in Luminaire: 1
Lamp Norminal Power(W):	Lamp Rated Voltage(V):
Lamp Tested Power(W): 4.137	Lamp Tested Voltage(V): 12.2
Lamp Tested Current(A): 0.338	Lamp Tested PF:
Lamp Size(W*L*H): 0.120*0.304*0.060	
Luminaire Speciality	
Luminaire Lumens(lm): 49.284	Beam Angle(10%Imax): 72.3
Luminaire Efficiency: 11.00%	Left=-34.4 Right=37.9
Luminaire EER(lm/W): 11.913	Field Angle(10%Imax): 112.6
Muximum Cand.(cd): 37.729	Spacing Criteria S/MH(C0_180): 0.985
Max Cd. Angle(°): C=90.0 γ =1.0	Spacing Criteria S/MH(C90_270): 1.006
Downward Lumens(lm): 49.284	CIE Type: Semi-Direct
Upward Lumens(lm): 0.000	ErP ϕ use(90deg): 42.372lm
Downward Total Efficiency%: 100.00	IRF(%): 174.020
Upward Total Efficiency%: 0.00	

IES Indoor Report

Photometric Filename: TT-2835-L600-2700K-5-Smoke LENS.IES

2D Light Intensity Distribution Curve

Plane [50%Ang.] [10%Ang.]

C90.0: 72.3 112.6

C0.0: 70.0 108.9

C90.0: 72.3 112.6

Polar Graph

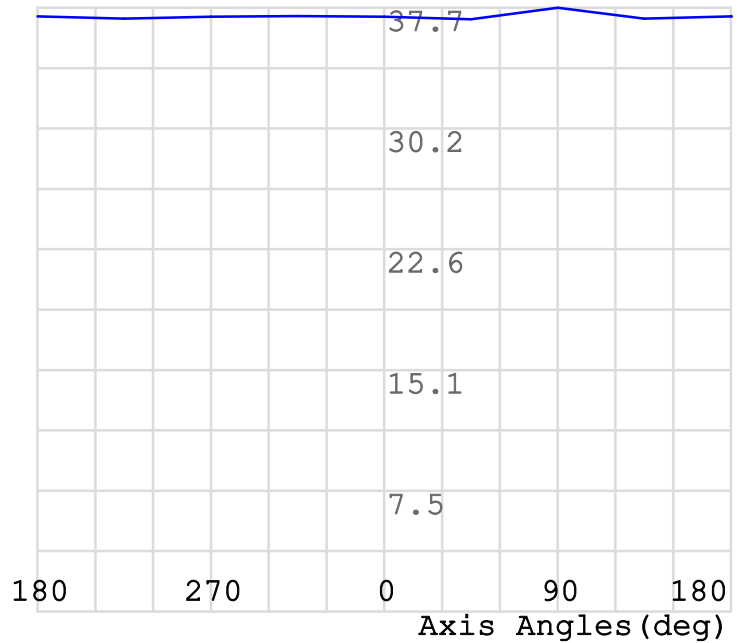
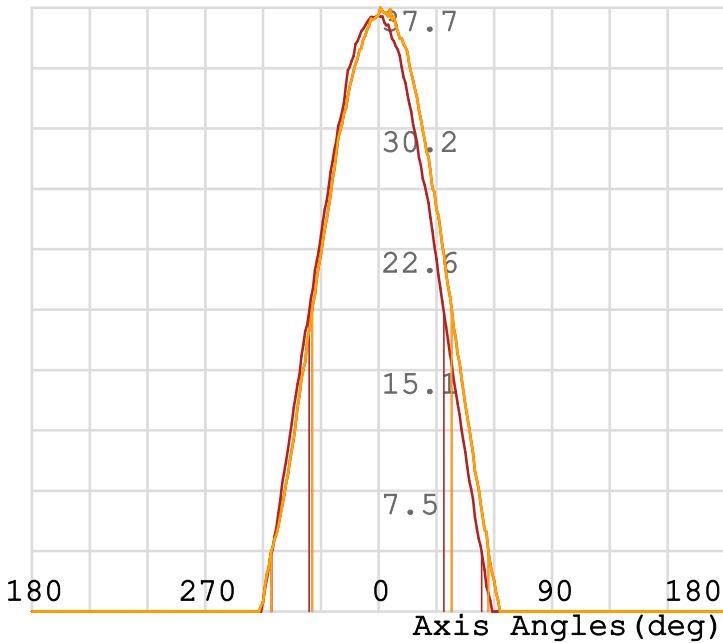
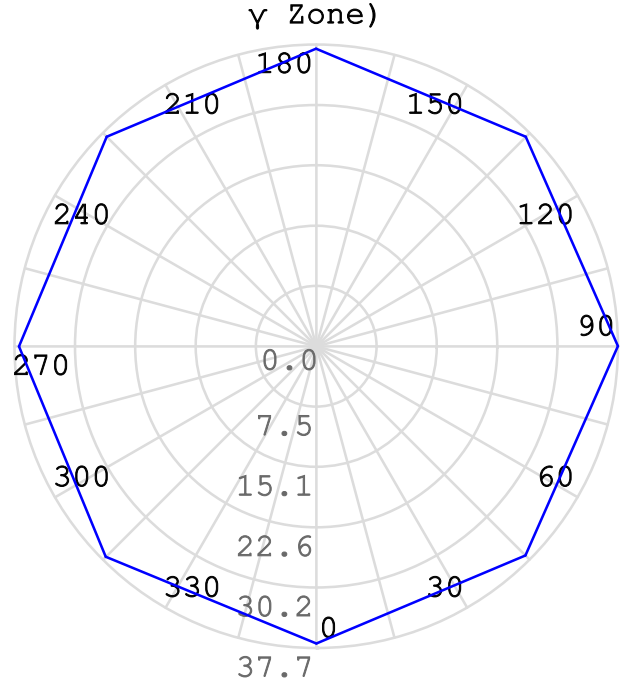
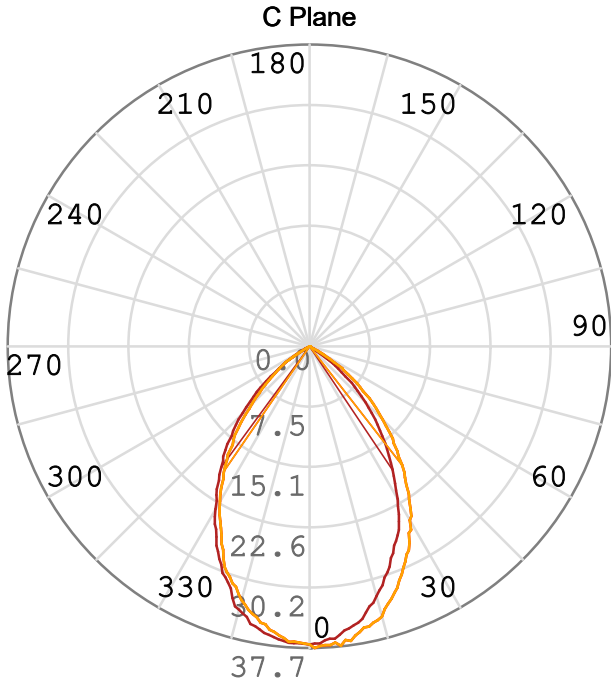

C Plane: C90.0_270.0 ——— C0.0_180.0 ——— C90.0_270.0 ———
 γ Cone: γ1.0 ———

IES Indoor Report

Photometric Filename: TT-2835-L600-2700K-5-Smoke LENS.IES

3D Light Intensity Distribution Curve

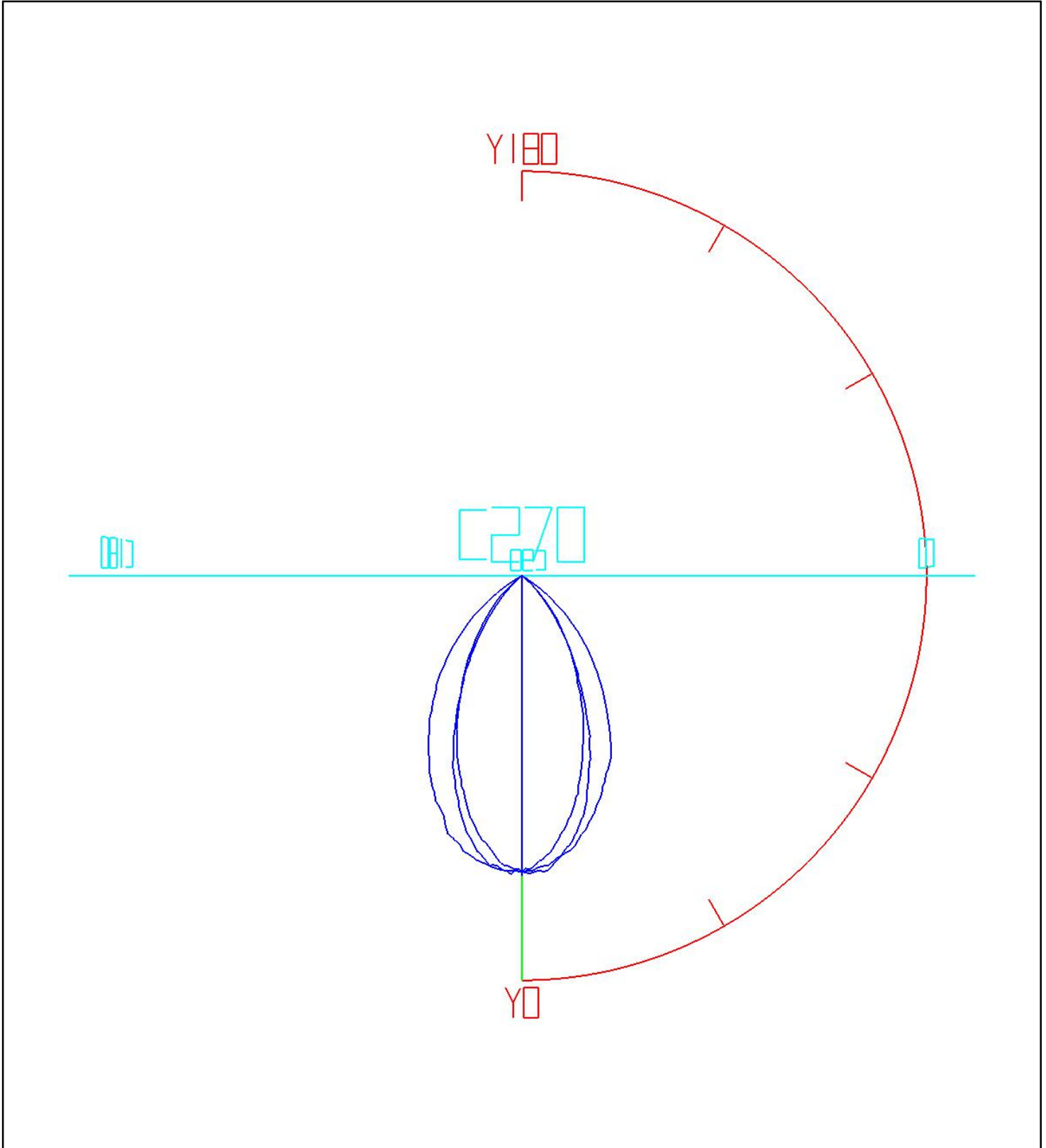

Curves: 3D Model ——— Fixture ——— Vert. HUD ——— Hori. HUD ———
View Angles: Orient:0 Tilt:0 Roll:0 Spin:0

IES Indoor Report

Photometric Filename: TT-2835-L600-2700K-5-Smoke LENS.IES

Rectangle ISO Light Intensity Curve

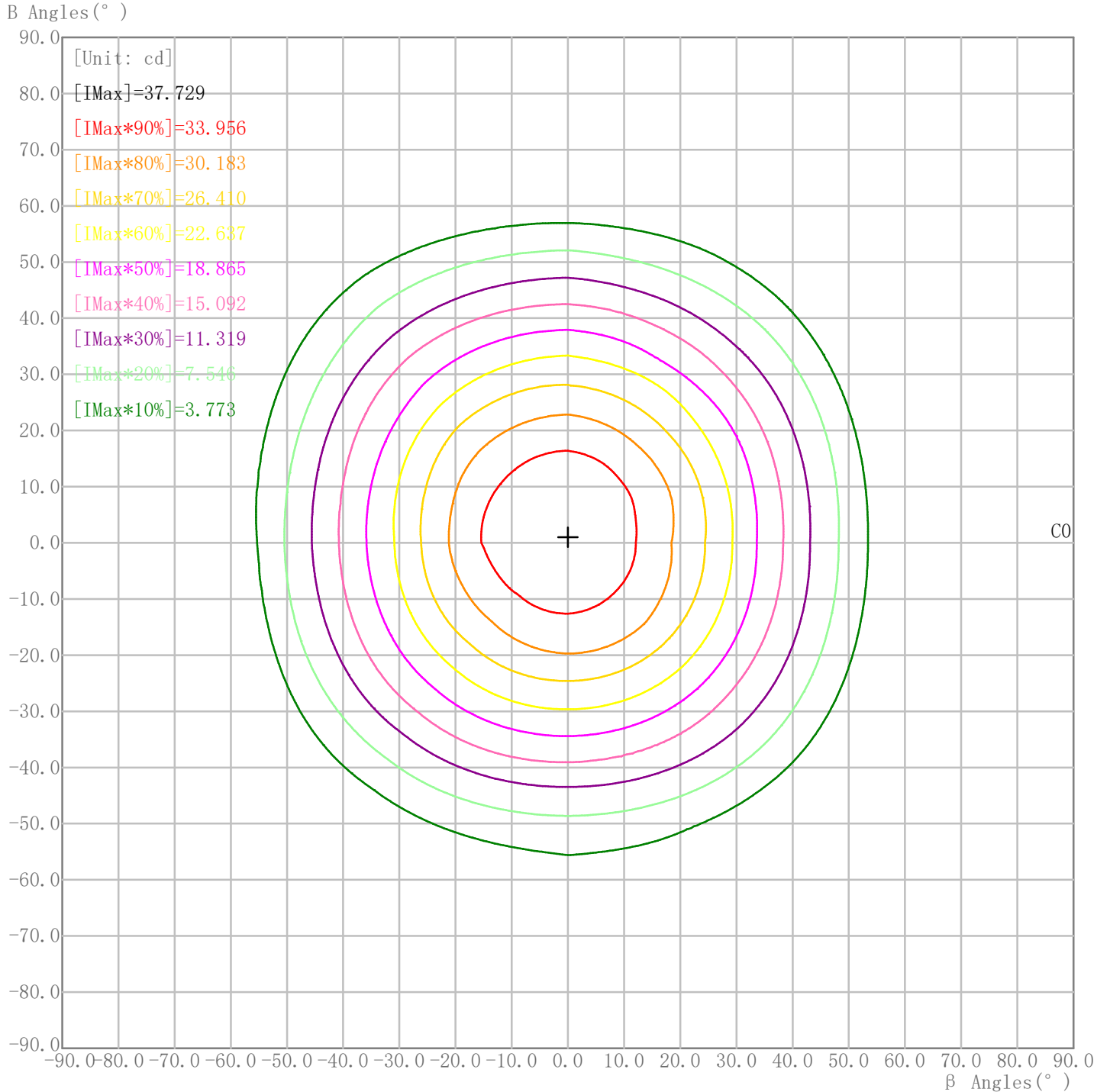

Curves: 90% — 80% — 70% — 60% — 50% — 40% — 30% — 20% — 10% —

Maximum Light Intensity(cd): 37.73

Maximum Cd. Angles: H0.0 V1.0

IES Indoor Report

Photometric Filename: TT-2835-L600-2700K-5-Smoke LENS.IES

Plane ISO-Illuminance Curve

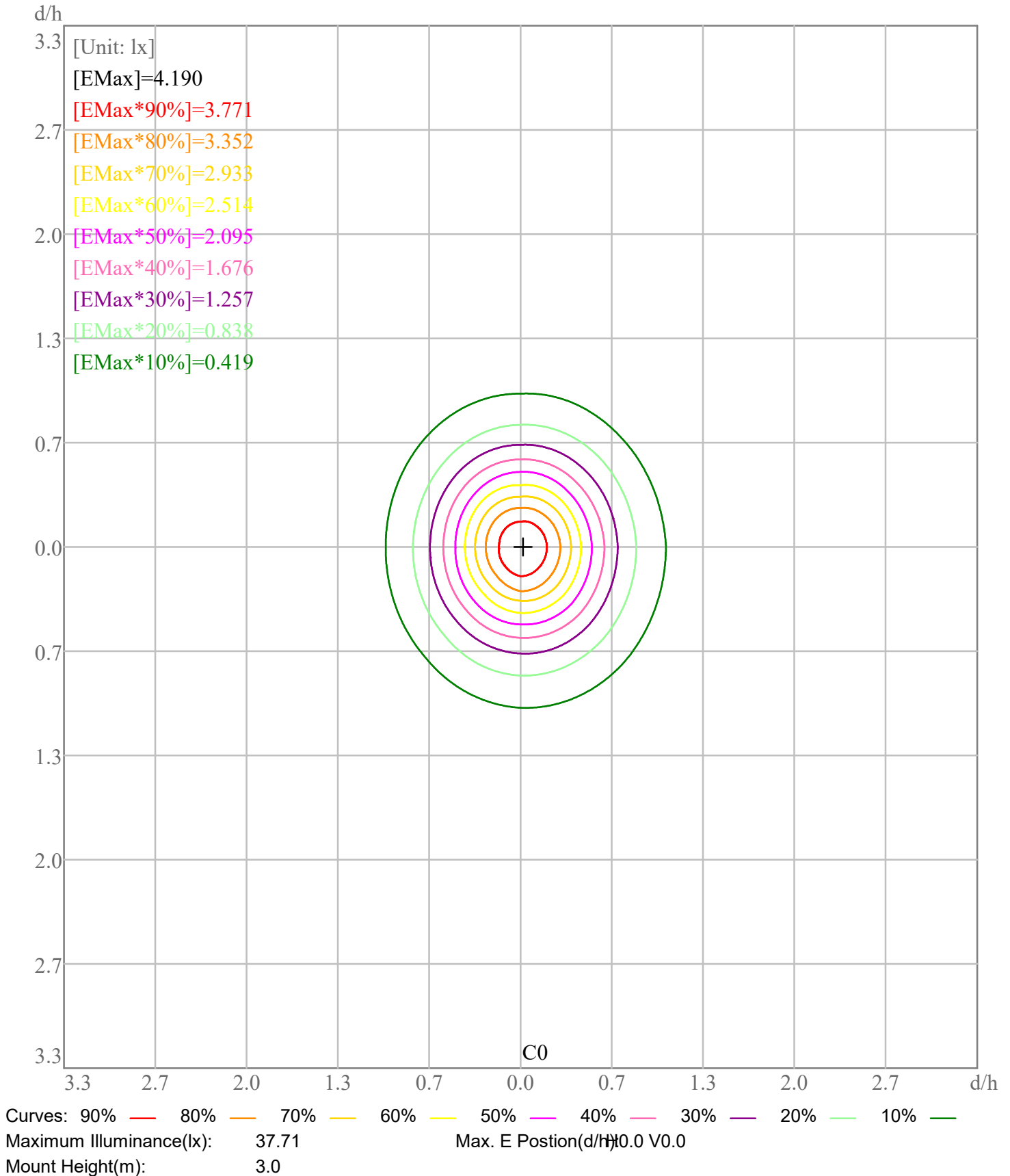

3D Plane ISO Illuminance Curve

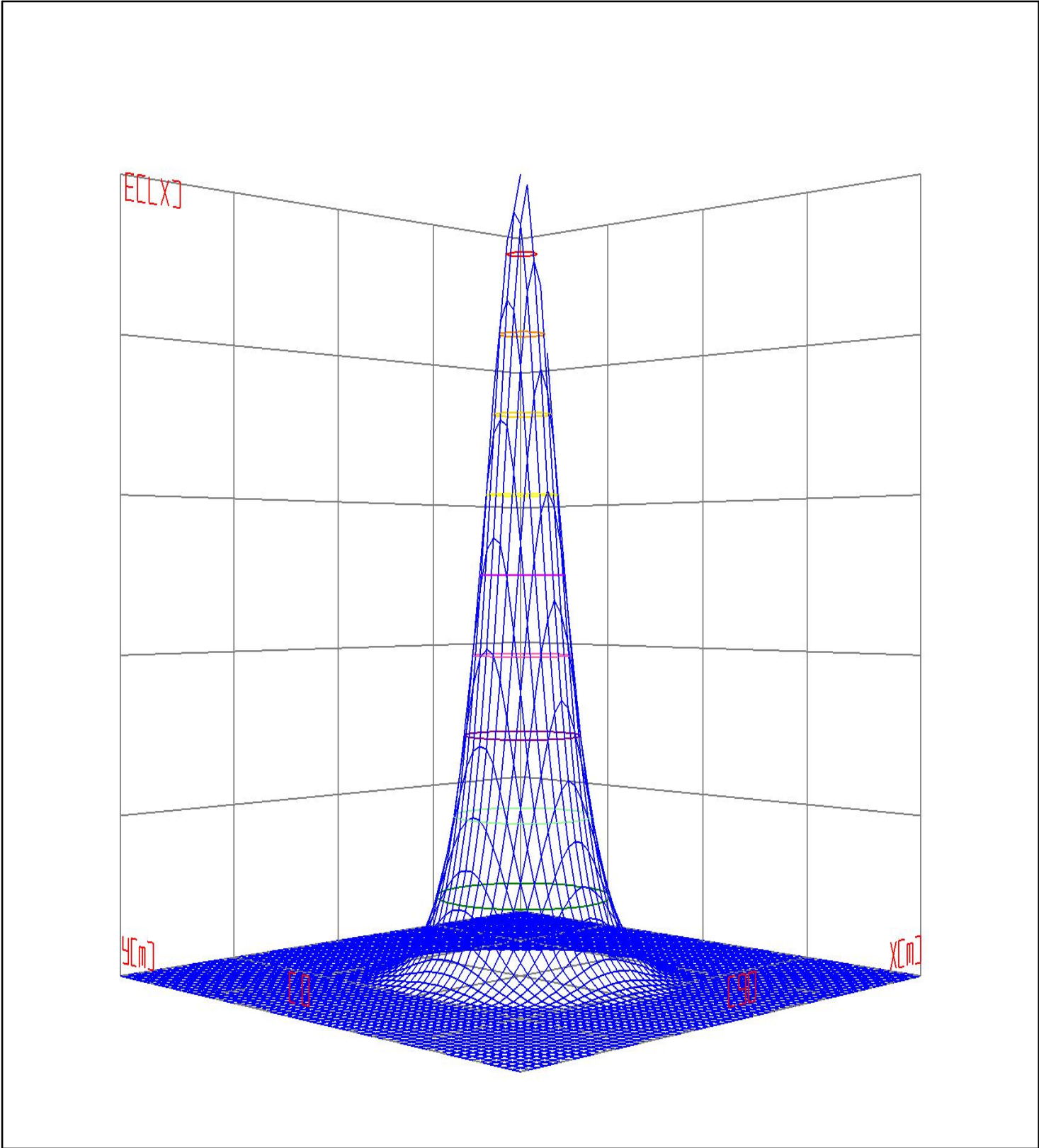

Curves: 3D Model — 90% — 80% — 70% — 60% — 50% — 40% — 30% — 20% — 10%
View Angles(deg): 0 Height(m): 3.0 Distance(m): 10.0

IES Indoor Report

Photometric Filename: TT-2835-L600-2700K-5-Smoke LENS.IES

Space ISO Illuminance Curve

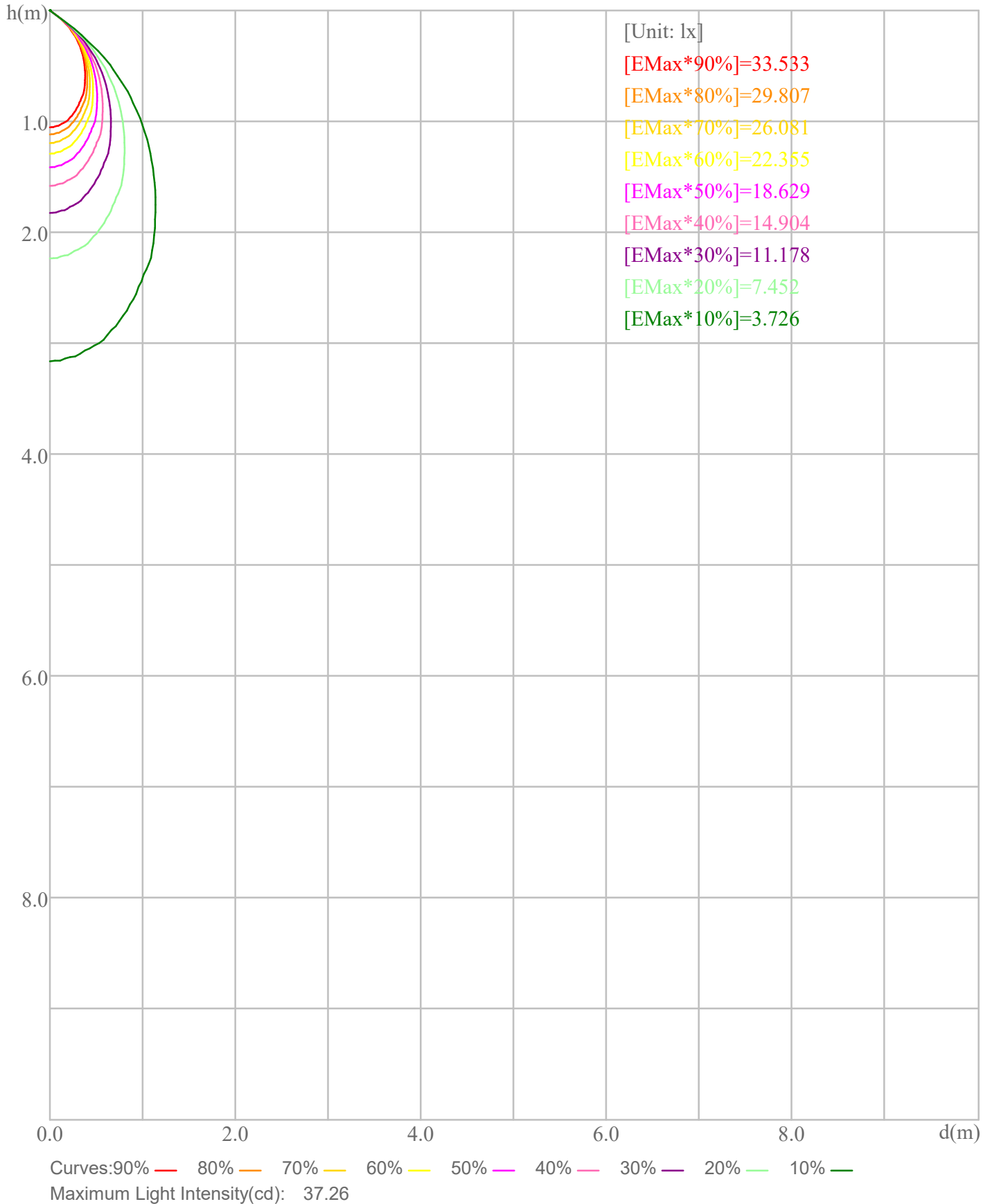

Illuminance-Distance Curve

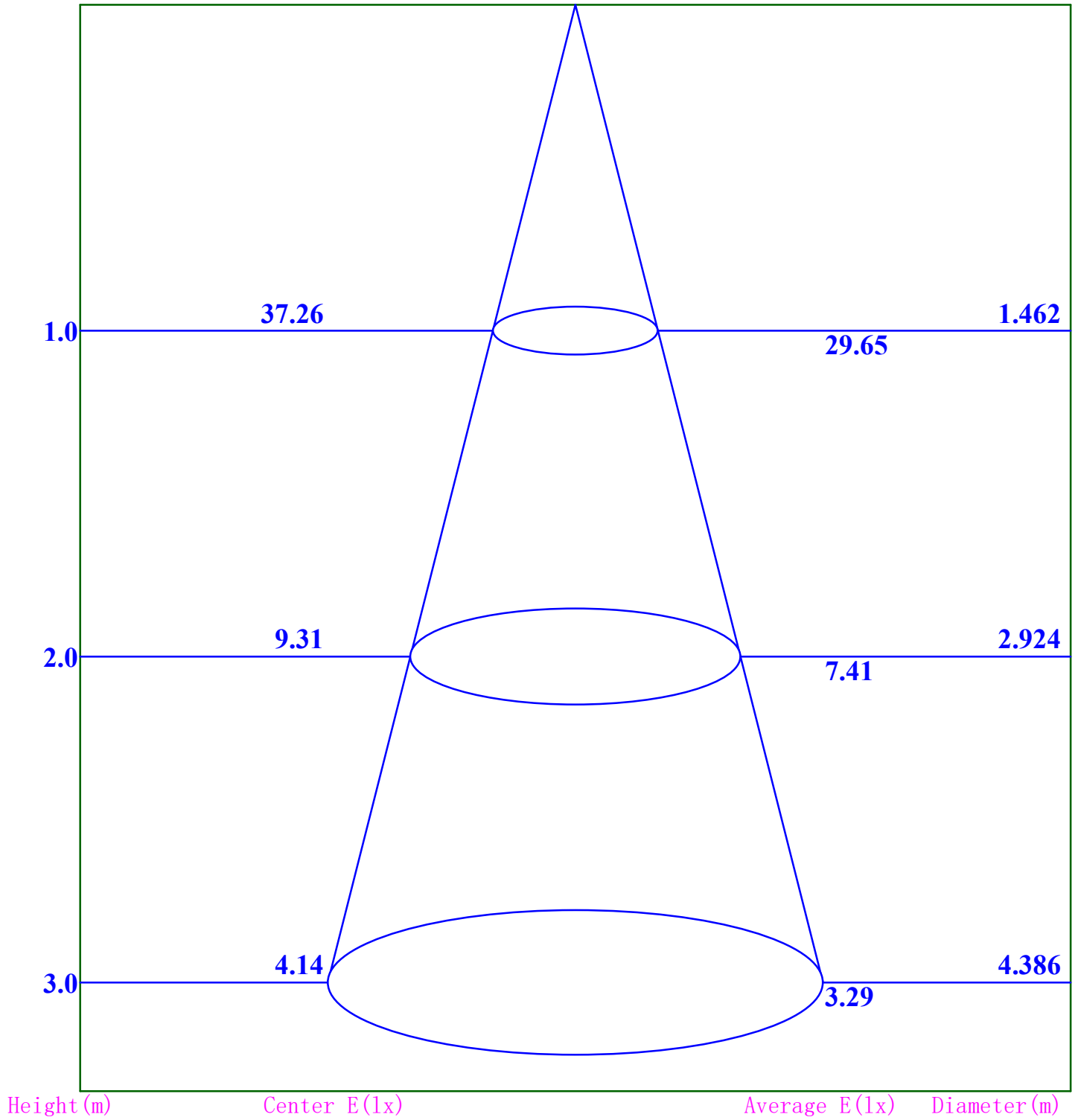

Beam Angle:72.3

IES Indoor Report

Photometric Filename:TT-2835-L600-2700K-5-Smoke LENS.IES

Indoor Luminance Limiting Curve

Glare Grade Table

GI	Quality	Using Illuminance							
		a	b	c	d	e	f	g	h
1.15	A	2000	1000	500	<=300				
1.5	B		2000	1000	500	<=300			
1.85	C			2000	1000	500	<=300		
2.2	D				2000	1000	500	<=300	
2.55	E					2000	1000	500	<=300
		a	b	c	d	e	f	g	h

Luminance Table

Gama(deg)	45	50	55	60	65	70	75	80	85
C0	257	168	83	0	0	0	0	0	0
C90	333	249	164	71	0	0	0	0	0

Luminance Limiting Curve

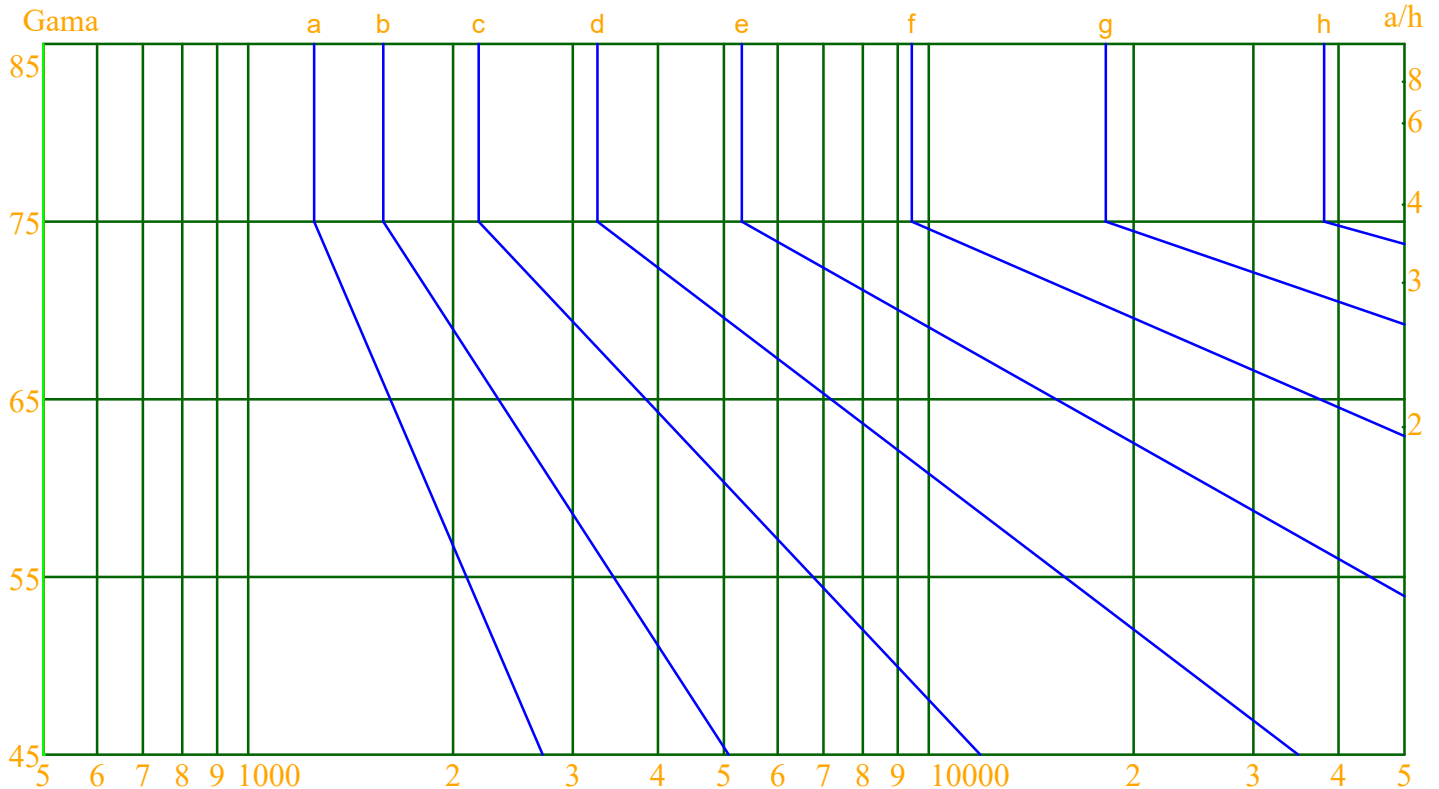

Luminous Size: Length(m)=0.304 Width(m)=0.120 Height(m)=0.060 Area(m²)=0.054720
 Luminous Type: Without Luminous Side
 Luminous Curves: C0-C180 Color: — C90-C270 Color: —

IES Indoor Report

Photometric Filename: TT-2835-L600-2700K-5-Smoke LENS.IES

Indoor Budgetary Estimate Table

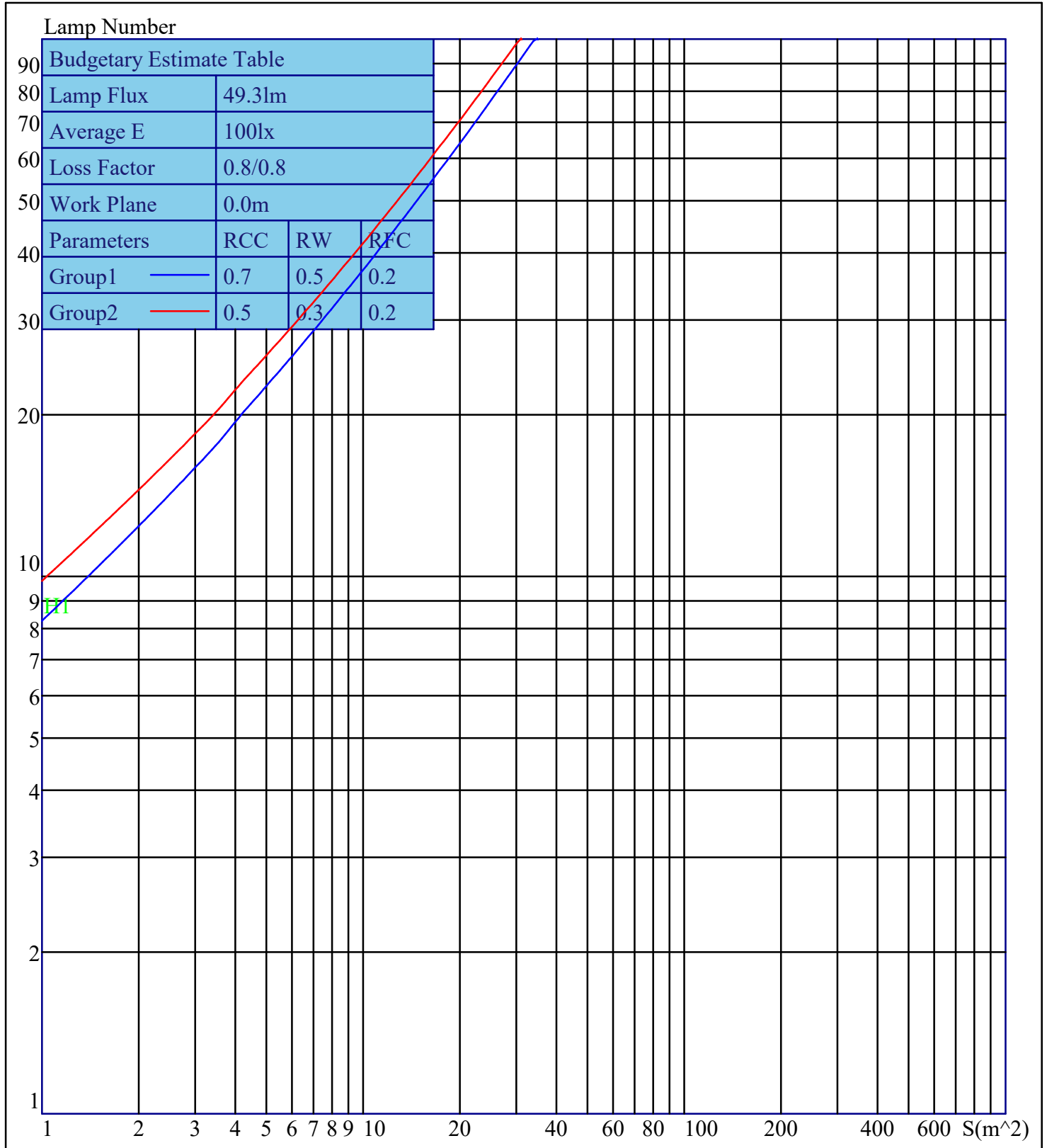

Parameters1: Rhocc = 0.7 Rhow = 0.5 Rhofc = 0.2 LLF = 0.8
 Parameters2: Rhocc = 0.5 Rhow = 0.3 Rhofc = 0.2 LLF = 0.8
 Average Illuminance(lx): 100 Cavity Height: H1(m) = 2