

# TITANIUM

TECHNOLOGY

TT-2835-L600

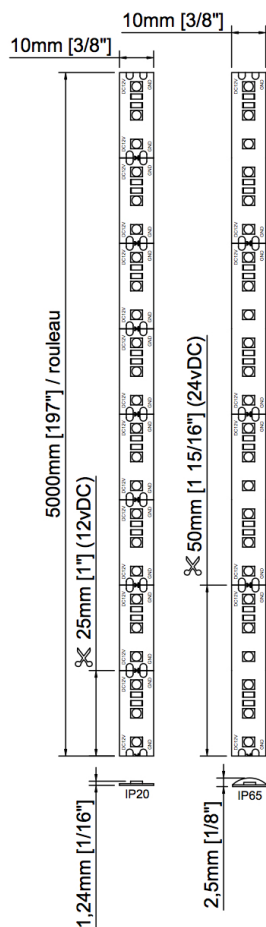

Voltage	<b>12vDC</b>	<b>24vDC</b>
LED/m	120 / m	
Power	16,4w / m 5w / feet 82w / roll	
Amperage	1,37A / m 0,42A / feet 6,84A / roll	0,69A / m 0,21A / feet 3,42A / roll
Lumen	27K - 243 lm/ feet 30K - 221 lm/ feet 35K - 246 lm/ feet 40K - 218 lm/ feet 60K - 245 lm/ feet	61 lm/ w 49 lm/ w 57 lm/ w 51 lm/ w -
CRI (RA)	90	
Angle	120°	
Size	IP20	10mm x 1,25mm x 5000mm 3/8" x 1/16" x 1967/8"
	IP65	10mm x 2,5mm x 5000mm 3/8" x 1/8" x 1967/8"
	IP67	13mm x 5mm x 5000mm 1/2" x 3/16" x 1967/8"
Cut line	25 mm 1"	50 mm 2"
Finish	White	
Dimmable	Yes	
LED Colour	<b>27K</b> - Warm white 2700K <b>30K</b> - Warm white 3000K <b>35K</b> - Neutral white 3500K <b>40K</b> - Neutral white 4000K <b>60K</b> - Cold white 6000K <b>R</b> - Red <b>G</b> - Green <b>B</b> - Blue <b>CB</b> - Crystal Blue <b>A</b> - Amber <b>O</b> - Orange <b>P</b> - Pink <b>UV</b> - UV 395~400nm <b>RGB</b> - Color mixing 3:1	
Working temp.	-40°C ~ 70°C	
IP	<b>20, 65, 67</b>	

## PRODUCT CODE

TT	SMD	LED PER ROLL	IP	LED COLOR	VOLTAGE
TT	2835	L600	20	27K	24V
TT	2835	L600			

# IES Indoor Report

Photometric Filename:TT-2835-L600-3000K-2-Frosted LENS.IES

## Indoor Luminaire Photometric Data

### Description Information

Luminaire Name: TT-2835-L600-3000k-2-Frosted-lens	Luminaire Catalog:	Test ID:
Lamp Name: TT-2835-L600-3000k-2-Frosted-lens	Lamp Catalog: 2835	Test Date: 2021/03/20
Manufacture: TITANIUM TECHNOLOGIE	ShieldingAngle(°):	Test Machine: GON-2000
Test Lab:	Frequency(Hz):	Luminaire CCT(K):
Luminaire Size(W*L*H): 0.120*0.304*0.060	Lighting Area(m2): 0.055	Luminaire Weight(kg): 0.100
Test System: C, $\gamma$	Test Step: C=45.0 $\gamma$ =1.0	Temperature(°C): 25
		Humidity(%):

### Character Parameter

Lamp Speciality Parameter	
Lamp Rated Lumens(lm): 448.000	Lamp Number in Luminaire: 1
Lamp Norminal Power(W):	Lamp Rated Voltage(V):
Lamp Tested Power(W): 4.260	Lamp Tested Voltage(V): 12.1
Lamp Tested Current(A): 0.351	Lamp Tested PF:
Lamp Size(W*L*H): 0.120*0.304*0.060	
Luminaire Speciality	
Luminaire Lumens(lm): 133.928	Beam Angle(10%Imax): 93.9
Luminaire Efficiency: 29.89%	Left=-46.5 Right=47.4
Luminaire EER(lm/W): 31.439	Field Angle(10%Imax): 139.1
Muximum Cand.(cd): 63.937	Spacing Criteria S/MH(C0_180): 1.138
Max Cd. Angle(°): C=270.0 $\gamma$ =1.0	Spacing Criteria S/MH(C90_270): 1.158
Downward Lumens(lm): 133.928	CIE Type: Semi-Direct
Upward Lumens(lm): 0.000	ErP $\phi$ use(120deg): 120.930lm
Downward Total Efficiency%: 100.00	IRF(%): 128.071
Upward Total Efficiency%: 0.00	

# IES Indoor Report

Photometric Filename: TT-2835-L600-3000K-2-Frosted LENS.IES

## 2D Light Intensity Distribution Curve

Plane [50%Ang.] [10%Ang.]

C270.0: 93.9 139.1

C0.0: 92.9 139.0

C90.0: 93.9 139.1

Polar Graph

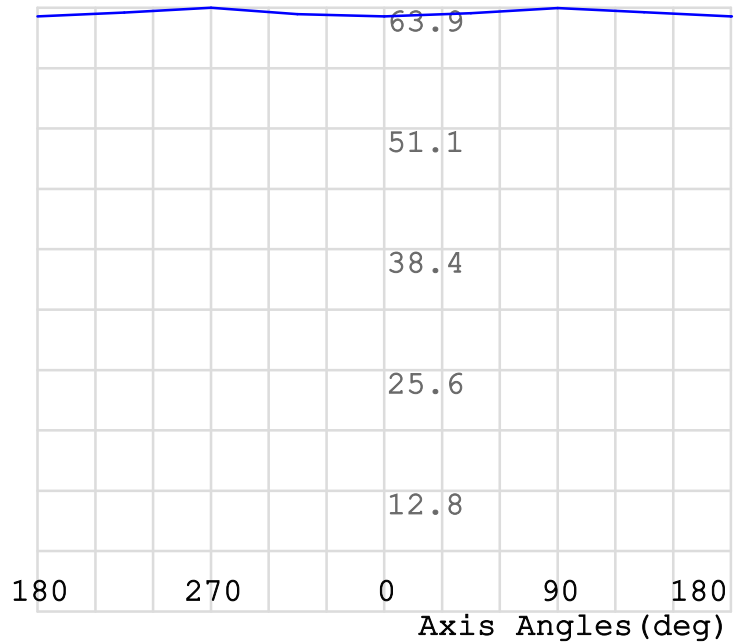
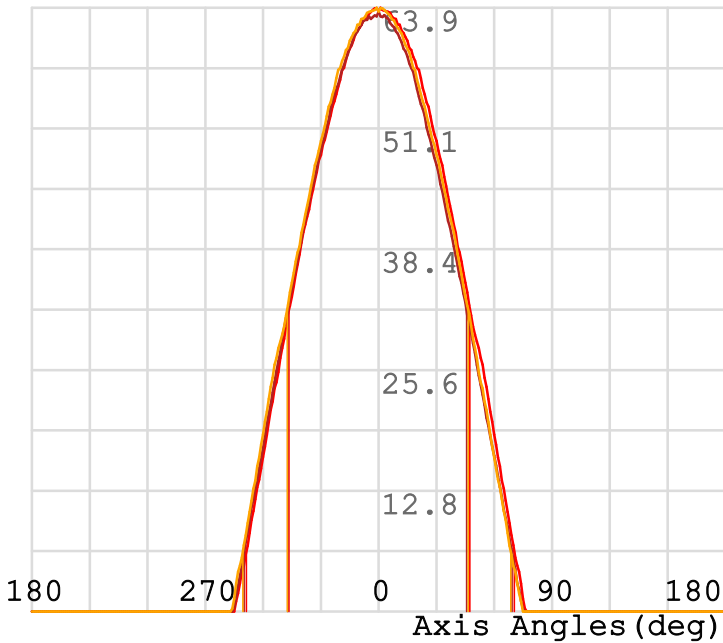
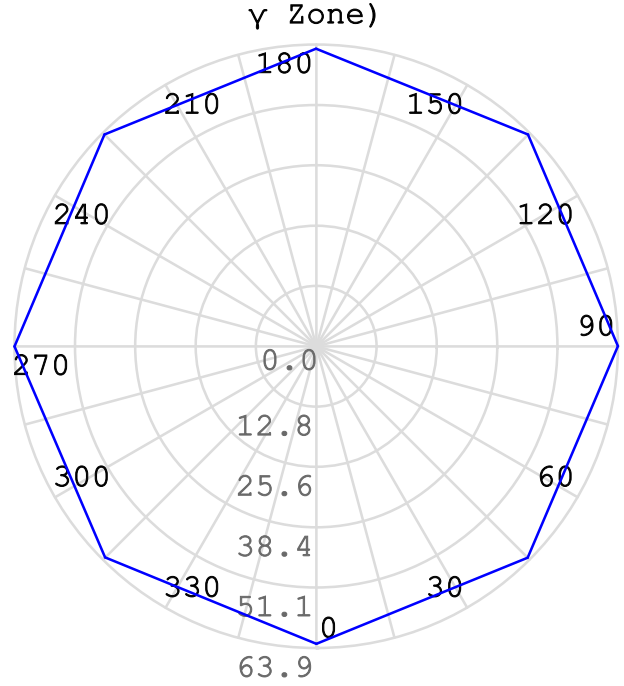
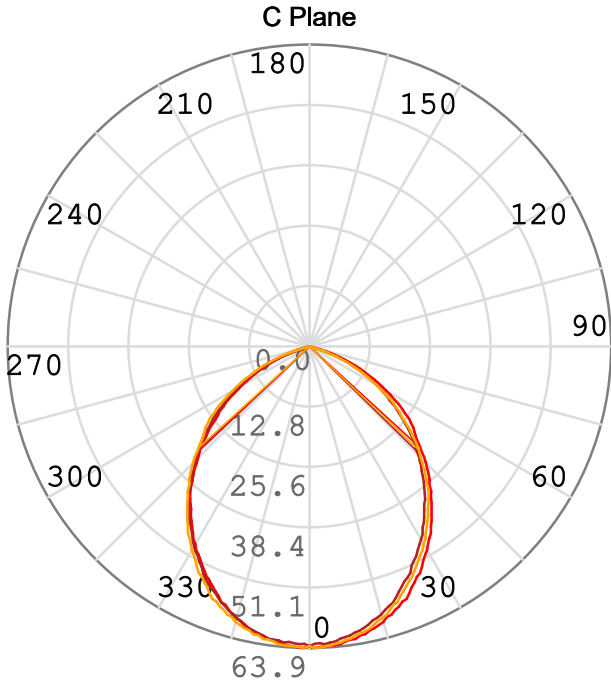

C Plane: C270.0\_90.0 ——— C0.0\_180.0 ——— C90.0\_270.0 ———  
 γ Cone: γ1.0 ———

3D Light Intensity Distribution Curve

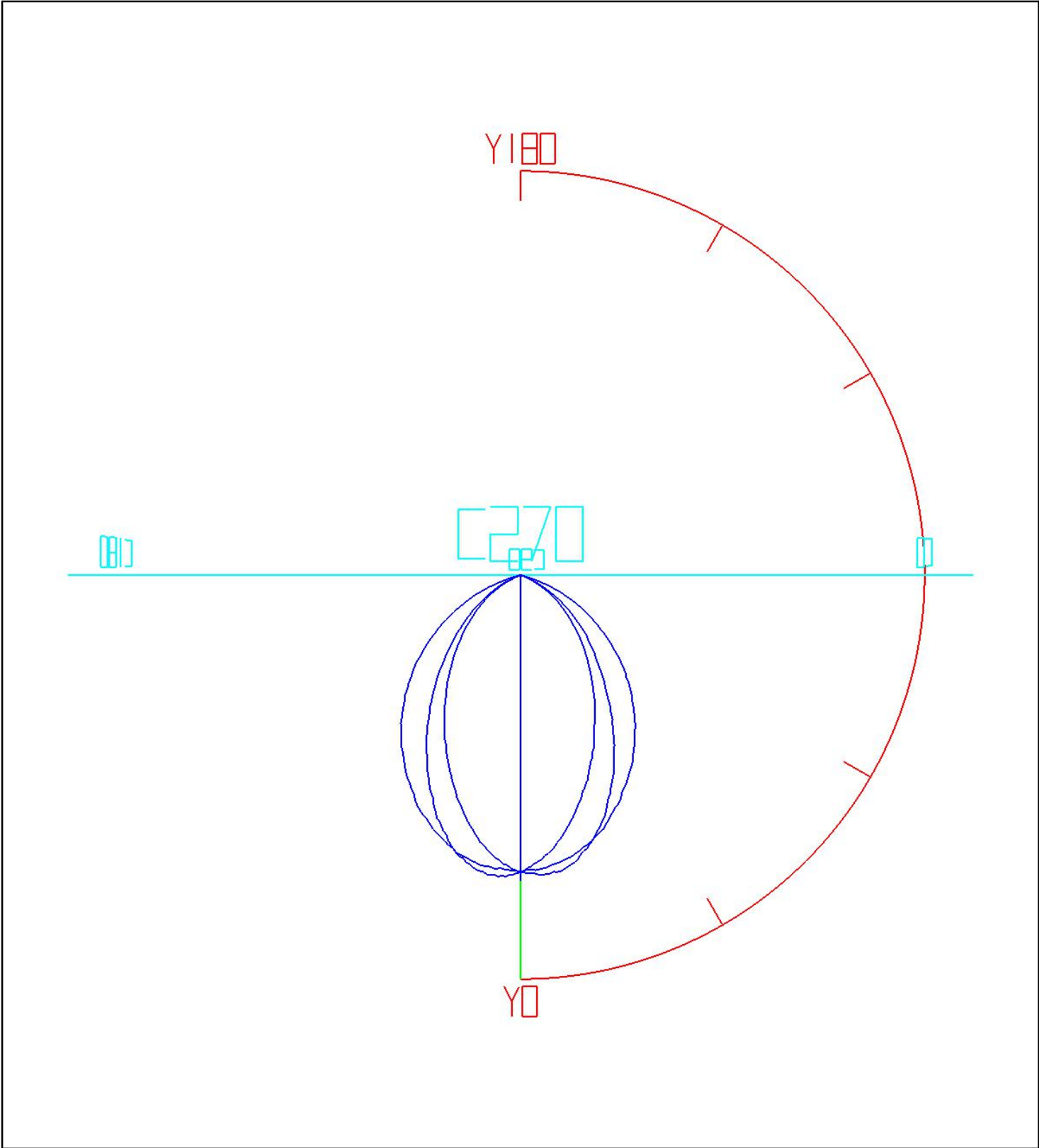

Curves: 3D Model ——— Fixture ——— Vert. HUD ——— Hori. HUD ———  
View Angles: Orient:0 Tilt:0 Roll:0 Spin:0

# IES Indoor Report

Photometric Filename: TT-2835-L600-3000K-2-Frosted LENS.IES

## Rectangle ISO Light Intensity Curve

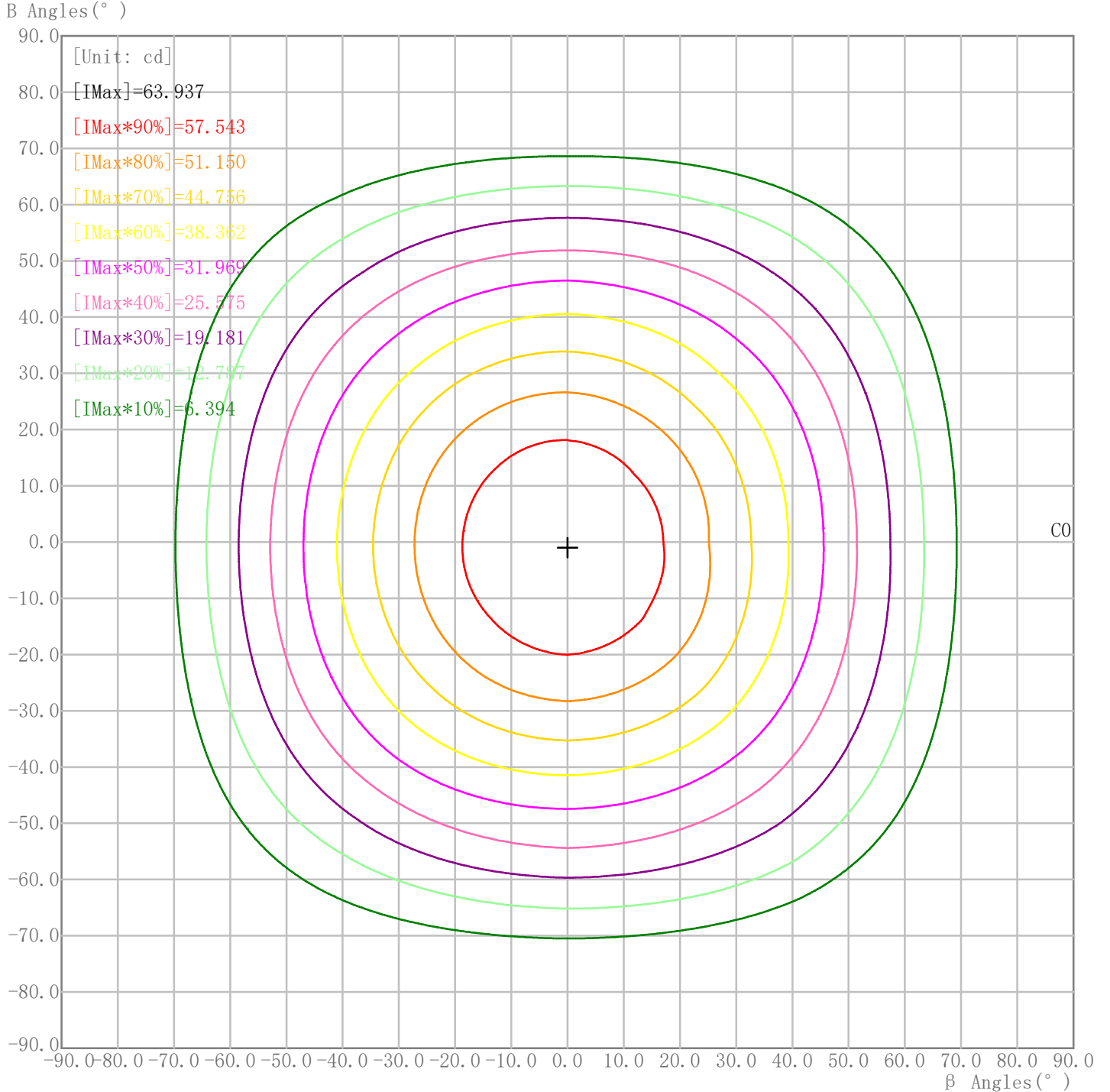

Curves: 90% — 80% — 70% — 60% — 50% — 40% — 30% — 20% — 10% —

Maximum Light Intensity(cd): 63.94

Maximum Cd. Angles: H-0.0 V-1.0

# IES Indoor Report

Photometric Filename: TT-2835-L600-3000K-2-Frosted LENS.IES

## Plane ISO-Illuminance Curve

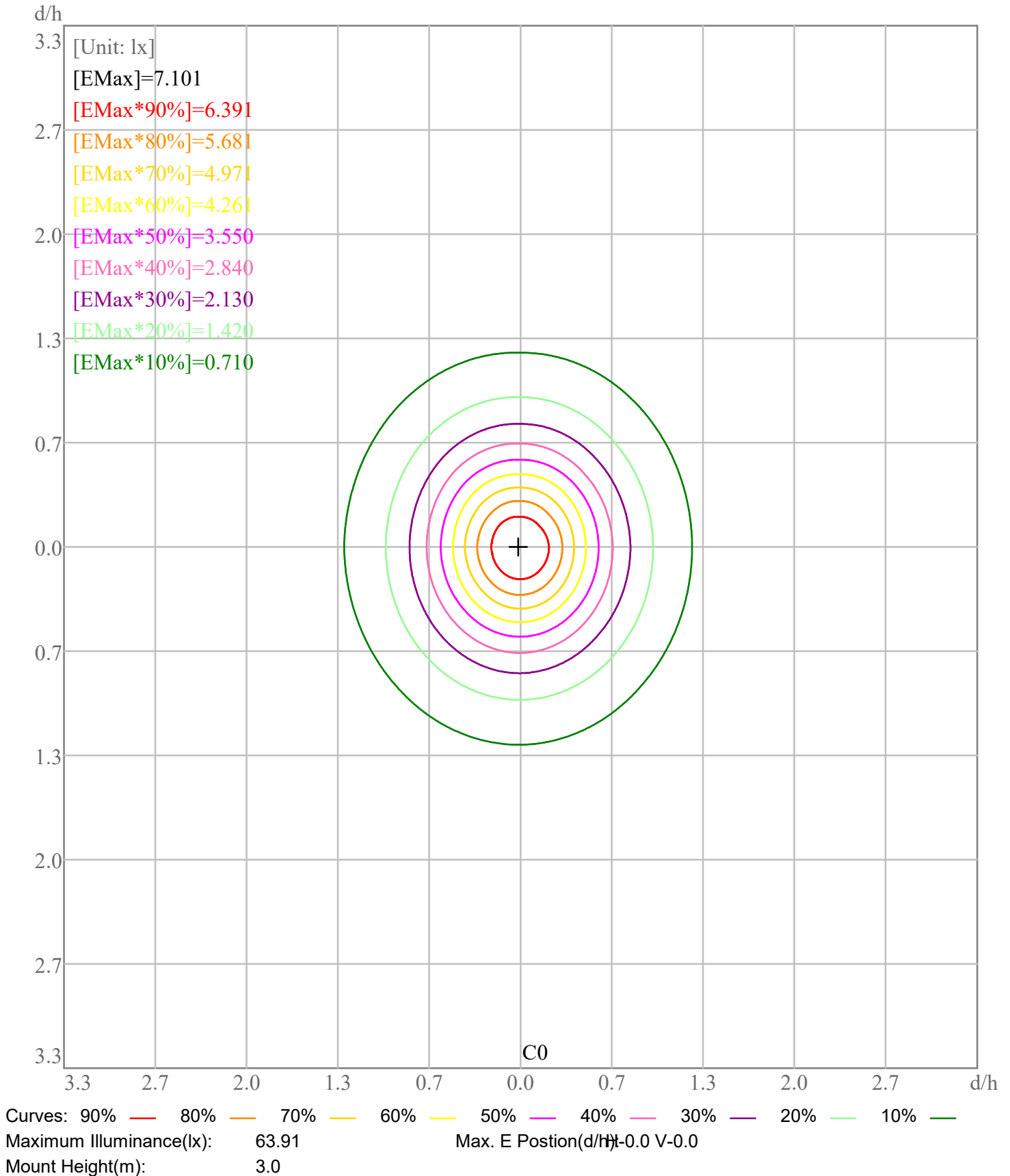

3D Plane ISO Illuminance Curve

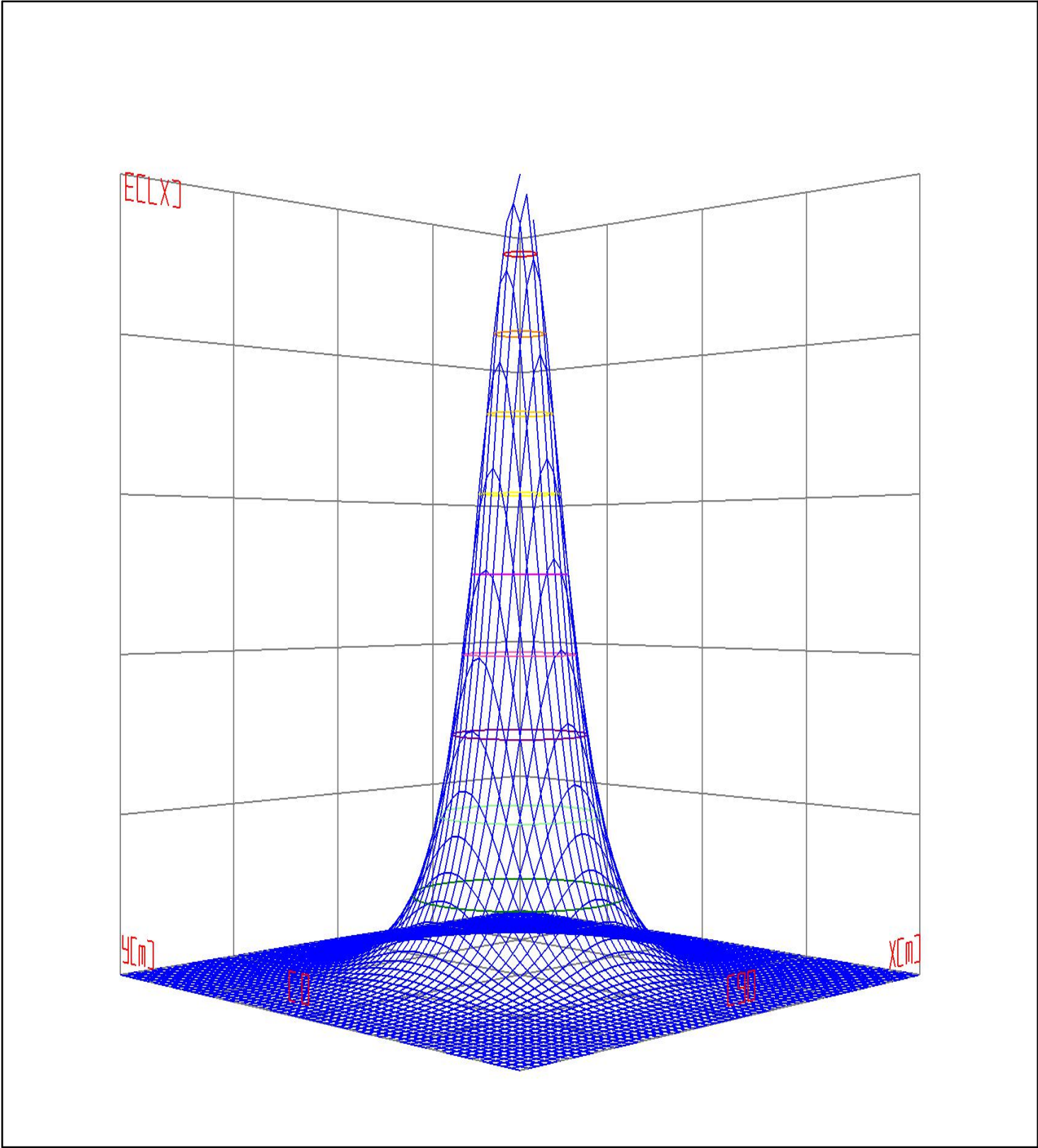

Curves: 3D Model — 90% — 80% — 70% — 60% — 50% — 40% — 30% — 20% — 10%  
View Angles(deg): 0      Height(m): 3.0      Distance(m): 10.0

# IES Indoor Report

Photometric Filename: TT-2835-L600-3000K-2-Frosted LENS.IES

## Space ISO Illuminance Curve

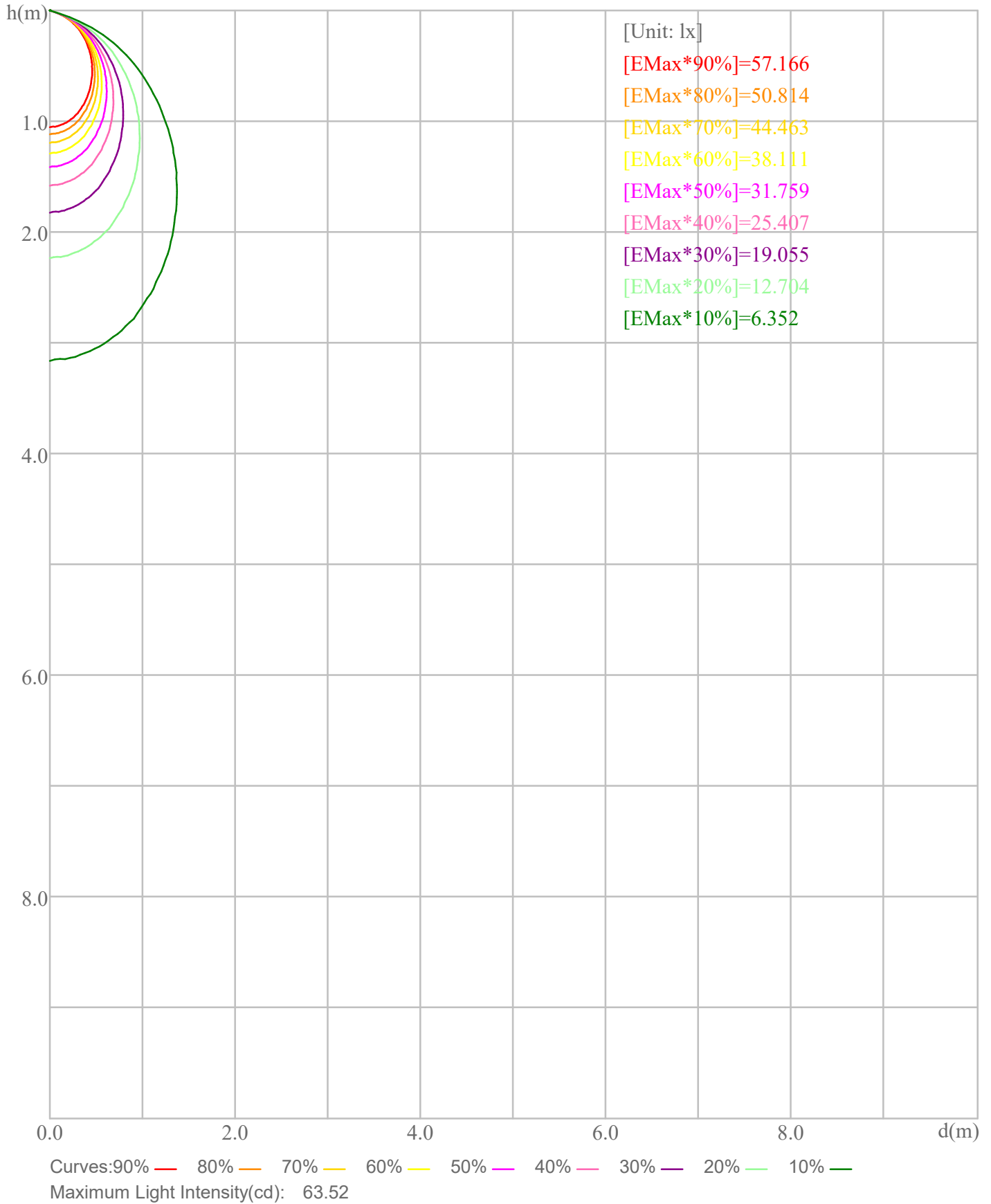



Illuminance-Distance Curve

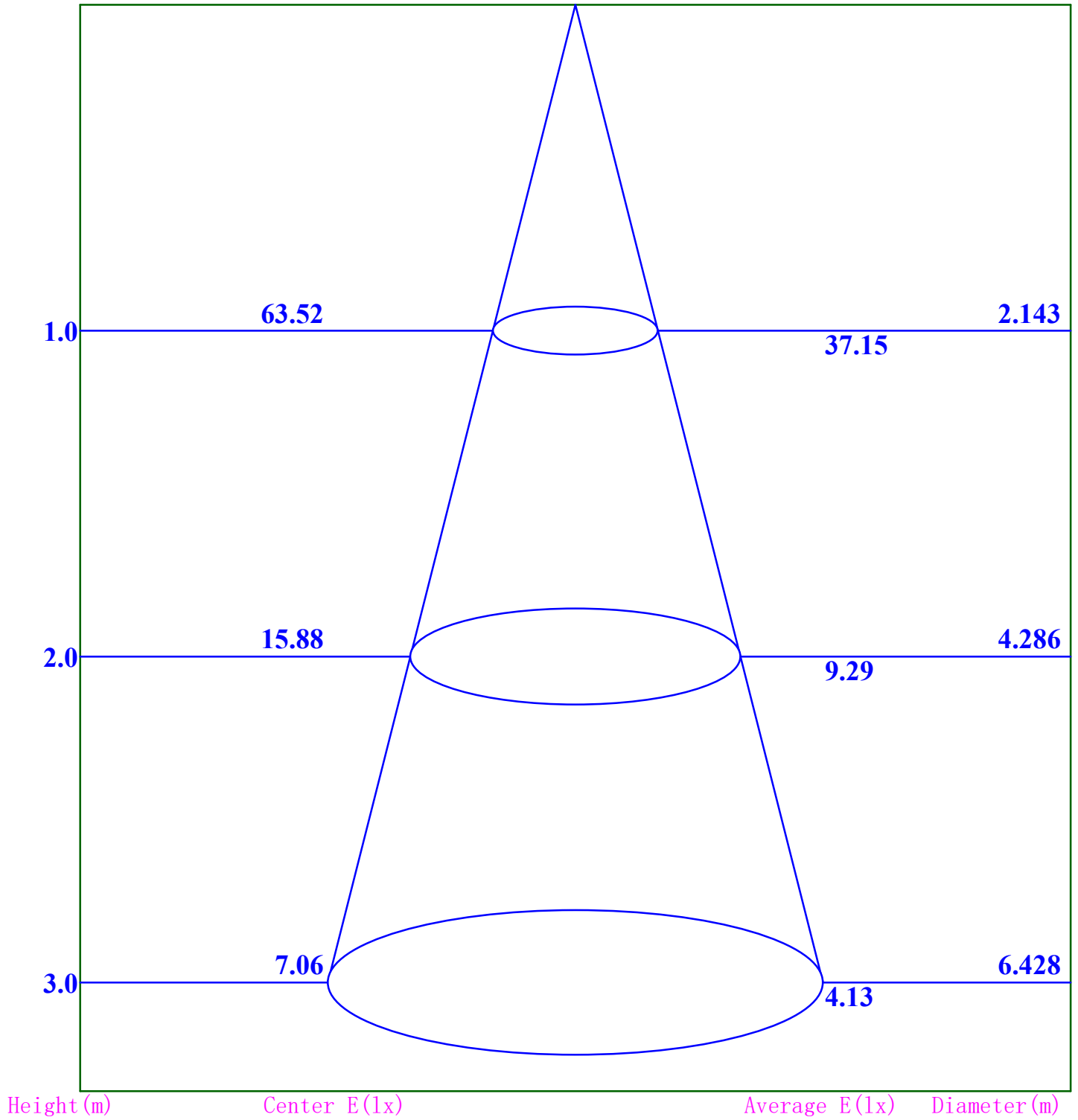

**Beam Angle:93.9**

# IES Indoor Report

Photometric Filename:TT-2835-L600-3000K-2-Frosted LENS.IES

## Indoor Luminance Limiting Curve

Glare Grade Table

GI	Quality	Using Illuminance							
		a	b	c	d	e	f	g	h
1.15	A	2000	1000	500	<=300				
1.5	B		2000	1000	500	<=300			
1.85	C			2000	1000	500	<=300		
2.2	D				2000	1000	500	<=300	
2.55	E					2000	1000	500	<=300
		a	b	c	d	e	f	g	h

Luminance Table

Gama(deg)	45	50	55	60	65	70	75	80	85
C0	846	779	697	603	468	291	23	0	0
C90	862	793	708	598	460	257	0	0	0

Luminance Limiting Curve

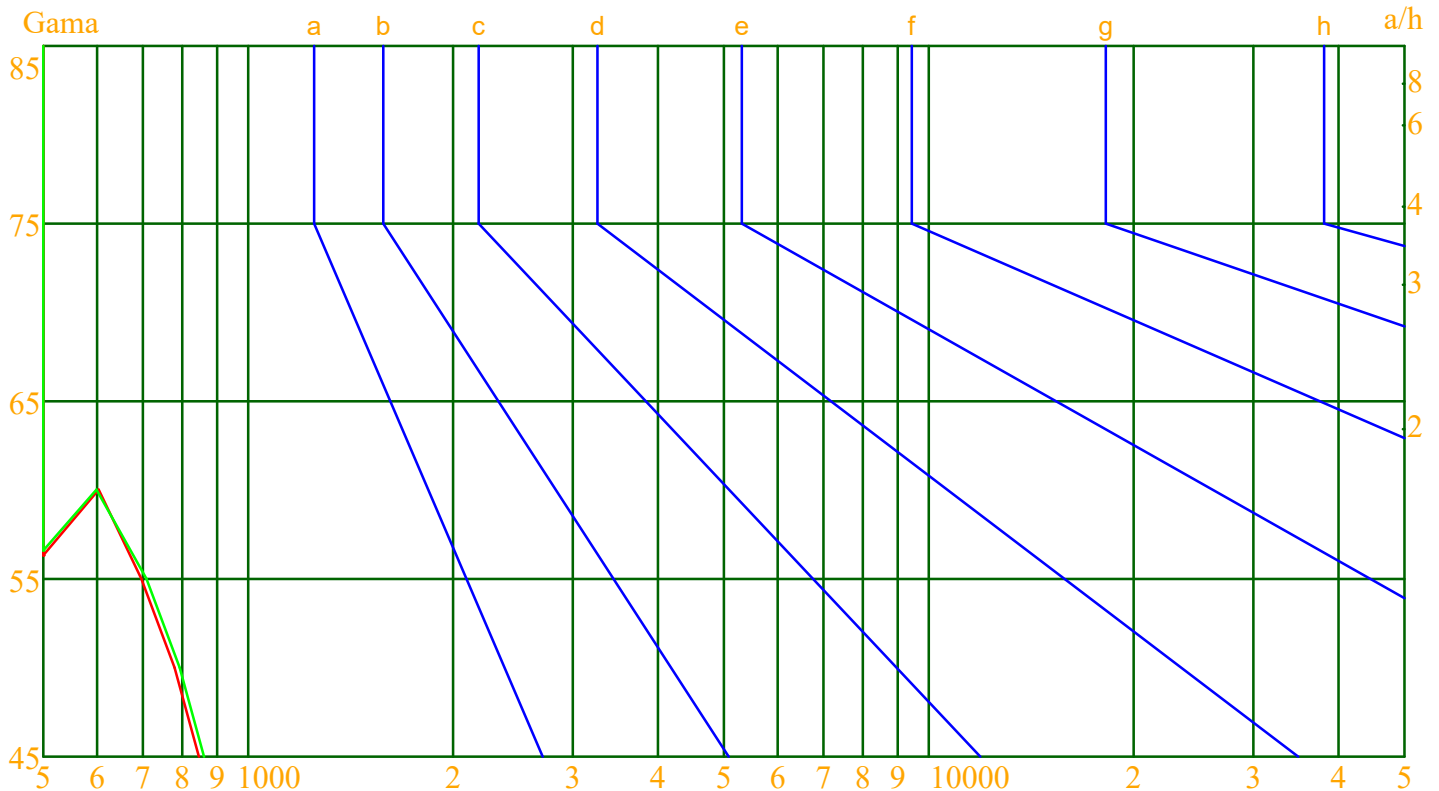

Luminous Size: Length(m)=0.304    Width(m)=0.120    Height(m)=0.060    Area(m<sup>2</sup>)=0.054720  
 Luminous Type: Without Luminous Side  
 Luminous Curves: C0-C180 Color: —    C90-C270 Color: —

# IES Indoor Report

Photometric Filename: TT-2835-L600-3000K-2-Frosted LENS.IES

## Indoor Budgetary Estimate Table

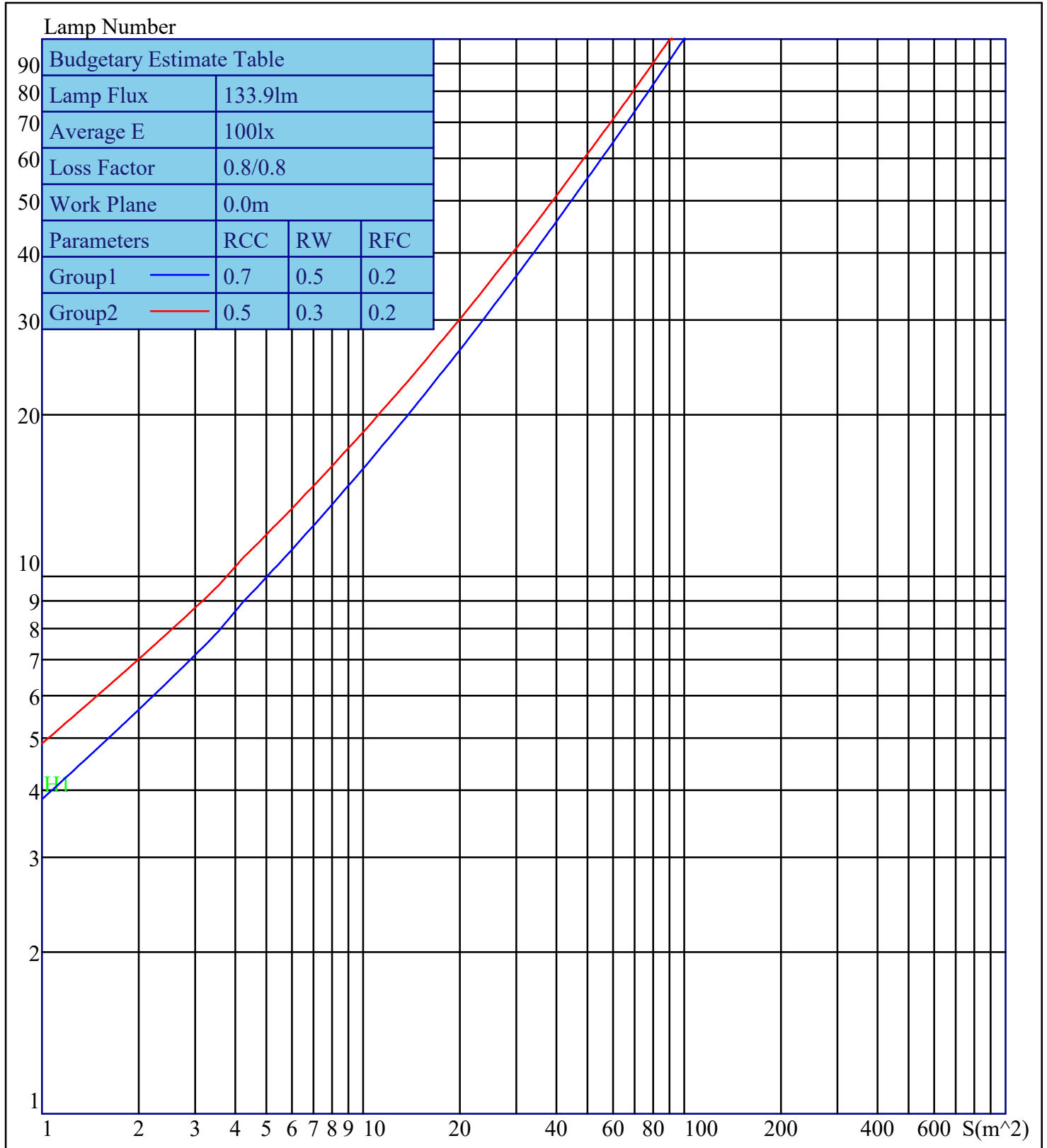

Parameters1: Rhocc = 0.7 Rhow = 0.5 Rhofc = 0.2 LLF = 0.8  
 Parameters2: Rhocc = 0.5 Rhow = 0.3 Rhofc = 0.2 LLF = 0.8  
 Average Illuminance(lx): 100 Cavity Height: H1(m) = 2