

TITANIUM

TECHNOLOGIE

TT-2835-L600

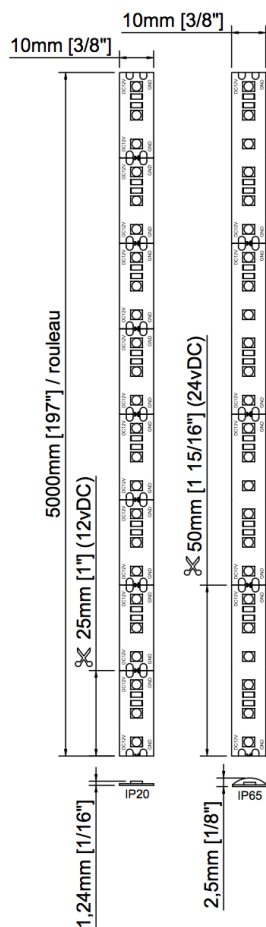

Tension	12vDC	24vDC
DEL/m	120 / m	
Puissance	16,4w / m 5w / pied 82w / rouleau	
Ampérage	1,37A / m 0,42A / pied 6,84A / rouleau	0,69A / m 0,21A / pied 3,42A / rouleau
Lumens	27K - 243 lm/ pied 30K - 221 lm/ pied 35K - 246 lm/ pied 40K - 218 lm/ pied 60K - 245 lm/ pied	61 lm/ w 49 lm/ w 57 lm/ w 51 lm/ w -
IRC (RA)	90	
Angle	120°	
Dimension	IP20	10mm x 1,25mm x 5000mm 3/8" x 1/16" x 1967/8"
	IP65	10mm x 2,5mm x 5000mm 3/8" x 1/8" x 1967/8"
	IP67	13mm x 5mm x 5000mm 1/2" x 3/16" x 1967/8"
Ligne de coupe	25 mm 1"	50 mm 2"
Finition	Blanc	
Gradable	Oui	
Couleur DEL	27K - Blanc chaud 2700K 30K - Blanc chaud 3000K 35K - Blanc neutre 3500K 40K - Blanc neutre 4000K 60K - Blanc froid 6000K R - Rouge G - Vert B - Bleu CB - Bleu IRCstal A - Ambre O - Orange P - Rose UV - UV 395~400nm RGB - Couleurs mixtes 3:1	
Temp. fonctionnement	-40°C ~ 70°C	
IP	20, 65, 67	

CODE PRODUIT

TT	-	SMD	-	DEL PAR ROULEAU	-	IP	-	COULEUR DEL	-	TENSION
TT	-	2835	-	L600	-	20	-	27K	-	24V
TT	-	2835	-	L600	-		-		-	

IES Indoor Report

Photometric Filename:TT-2835-L600-2700K-3-Milky LENS.IES

Indoor Luminaire Photometric Data

Description Information

Luminaire Name: TT-2835-L600-2700k-3-Milk lens		Luminaire Catalog:	Test ID:
Lamp Name: TT-2835-L600-2700k-3-Milk lens		Lamp Catalog: 2835	Test Date: 2021/03/19
Manufacture: TITANIUM TECHNOLOGIE		ShieldingAngle(°):	Test Machine: GON-2000
Test Lab:		Frequency(Hz):	Luminaire CCT(K):
Luminaire Size(W*L*H): 0.120*0.304*0.060		Lighting Area(m2): 0.055	Luminaire Weight(kg): 0.100
Test System: C, γ	Test Step: C=45.0 γ =1.0	Temperature(°C): 25	Humidity(%):

Character Parameter

Lamp Speciality Parameter	
Lamp Rated Lumens(lm): 448.000	Lamp Number in Luminaire: 1
Lamp Norminal Power(W):	Lamp Rated Voltage(V):
Lamp Tested Power(W): 4.165	Lamp Tested Voltage(V): 12.2
Lamp Tested Current(A): 0.341	Lamp Tested PF:
Lamp Size(W*L*H): 0.120*0.304*0.060	
Luminaire Speciality	
Luminaire Lumens(lm): 91.782	Beam Angle(10%Imax): 98.5
Luminaire Efficiency: 20.49%	Left=-49.9 Right=48.6
Luminaire EER(lm/W): 22.037	Field Angle(10%Imax): 137.5
Muximum Cand.(cd): 41.870	Spacing Criteria S/MH(C0_180): 1.202
Max Cd. Angle(°): C=0.0 γ =2.0	Spacing Criteria S/MH(C90_270): 1.210
Downward Lumens(lm): 91.782	CIE Type: Semi-Direct
Upward Lumens(lm): 0.000	ErP ϕ use(120deg): 83.730lm
Downward Total Efficiency%: 100.00	IRF(%): 121.427
Upward Total Efficiency%: 0.00	

IES Indoor Report

Photometric Filename: TT-2835-L600-2700K-3-Milky LENS.IES

2D Light Intensity Distribution Curve

Plane [50%Ang.] [10%Ang.]

C0.0: 98.5 137.5

C0.0: 98.5 137.5

C90.0: 98.8 138.5

Polar Graph

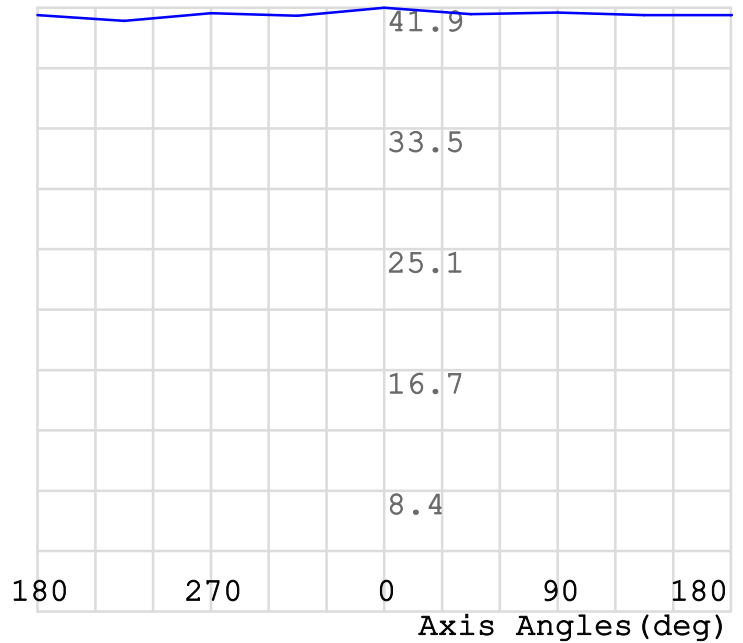
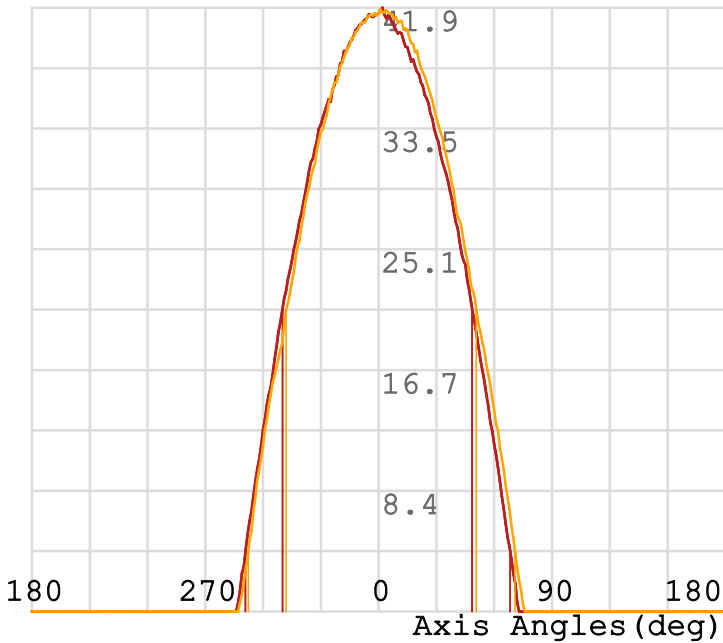
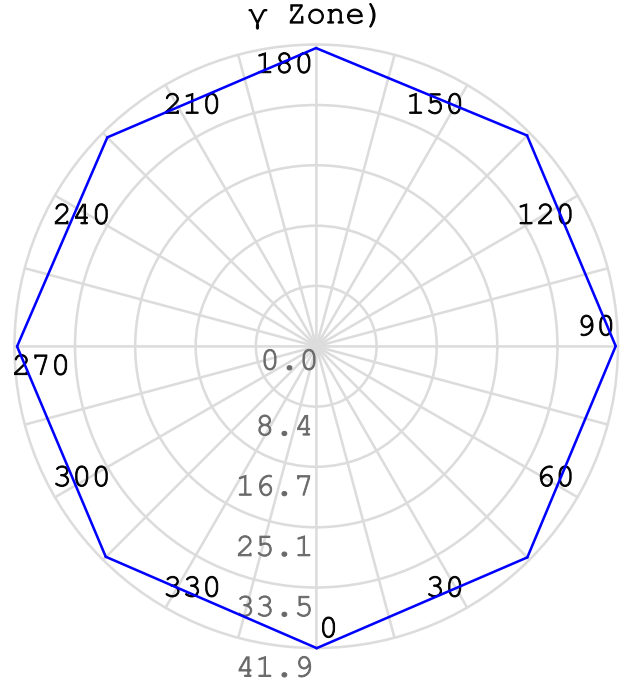
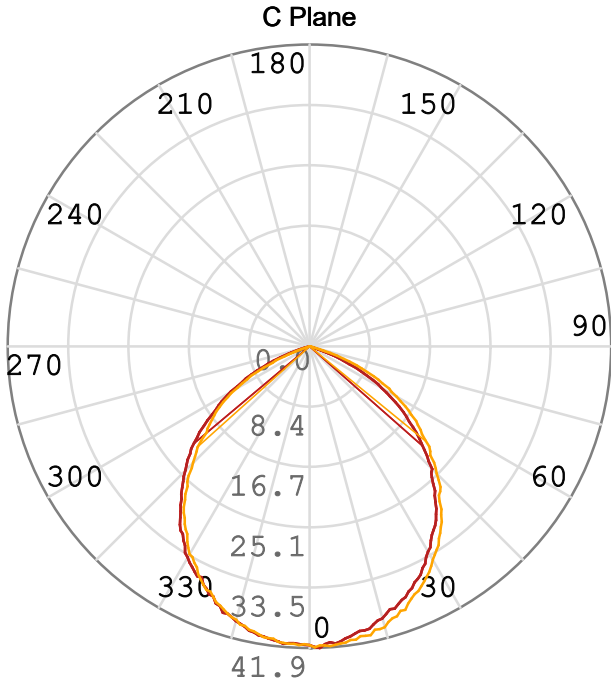

C Plane: C0.0_180.0 ——— C0.0_180.0

γ Cone: γ2.0 ———

C90.0_270.0 ———

3D Light Intensity Distribution Curve

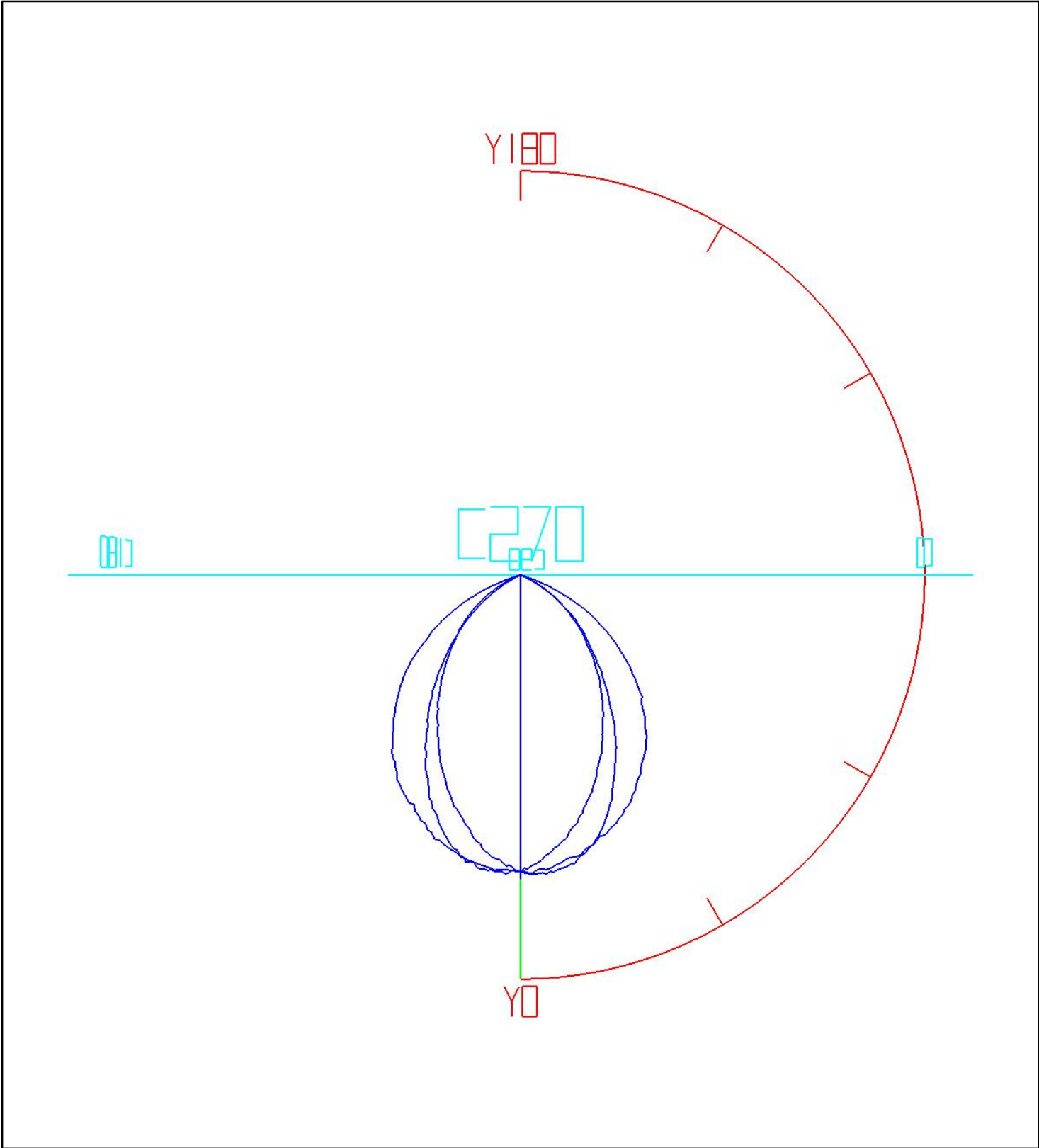

Curves: 3D Model ——— Fixture ——— Vert. HUD ——— Hori. HUD ———
View Angles: Orient:0 Tilt:0 Roll:0 Spin:0

IES Indoor Report

Photometric Filename: TT-2835-L600-2700K-3-Milky LENS.IES

Rectangle ISO Light Intensity Curve

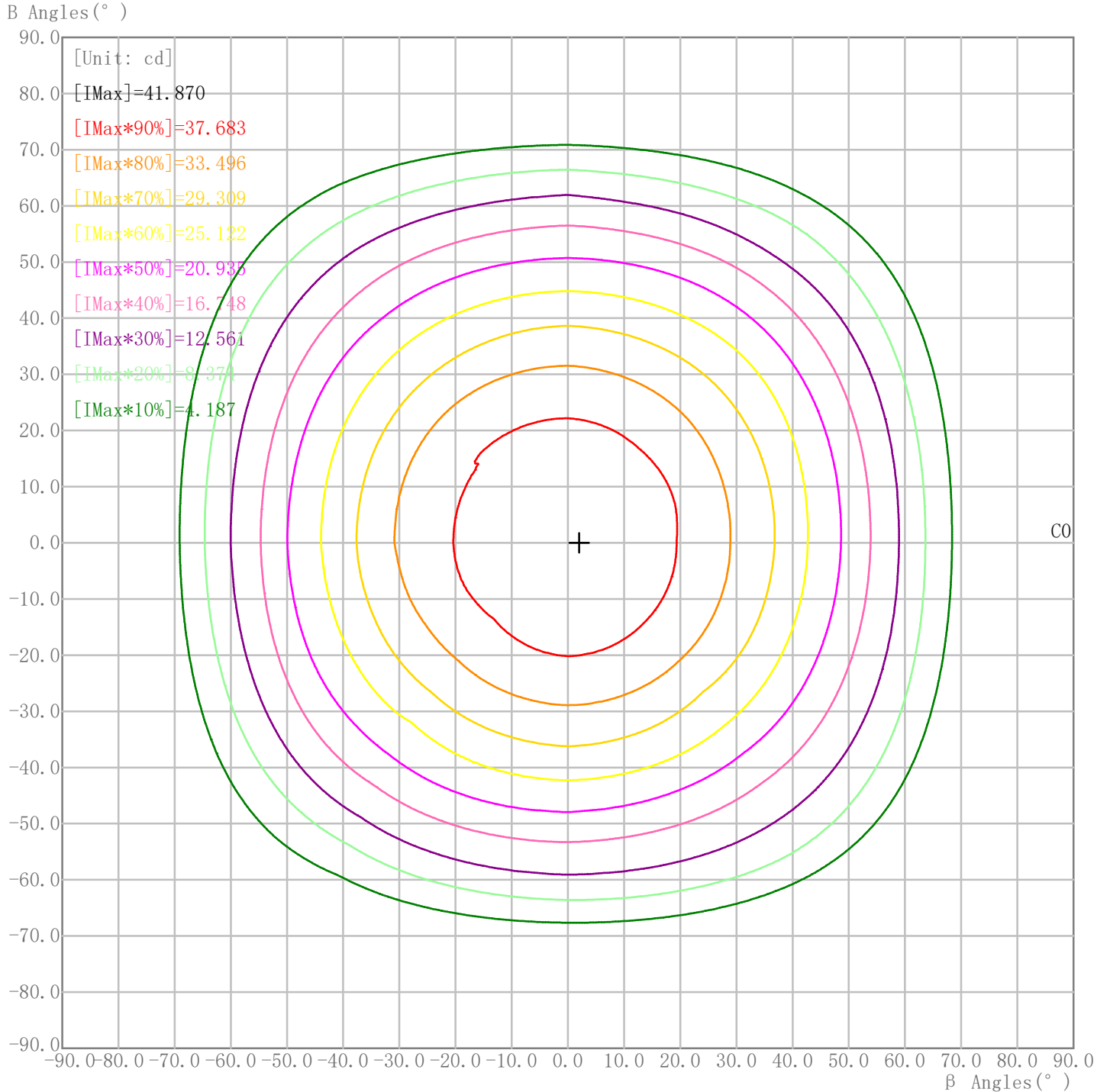

Curves: 90% — 80% — 70% — 60% — 50% — 40% — 30% — 20% — 10% —

Maximum Light Intensity(cd): 41.87

Maximum Cd. Angles: H2.0 V0.0

IES Indoor Report

Photometric Filename: TT-2835-L600-2700K-3-Milky LENS.IES

Plane ISO-Illuminance Curve

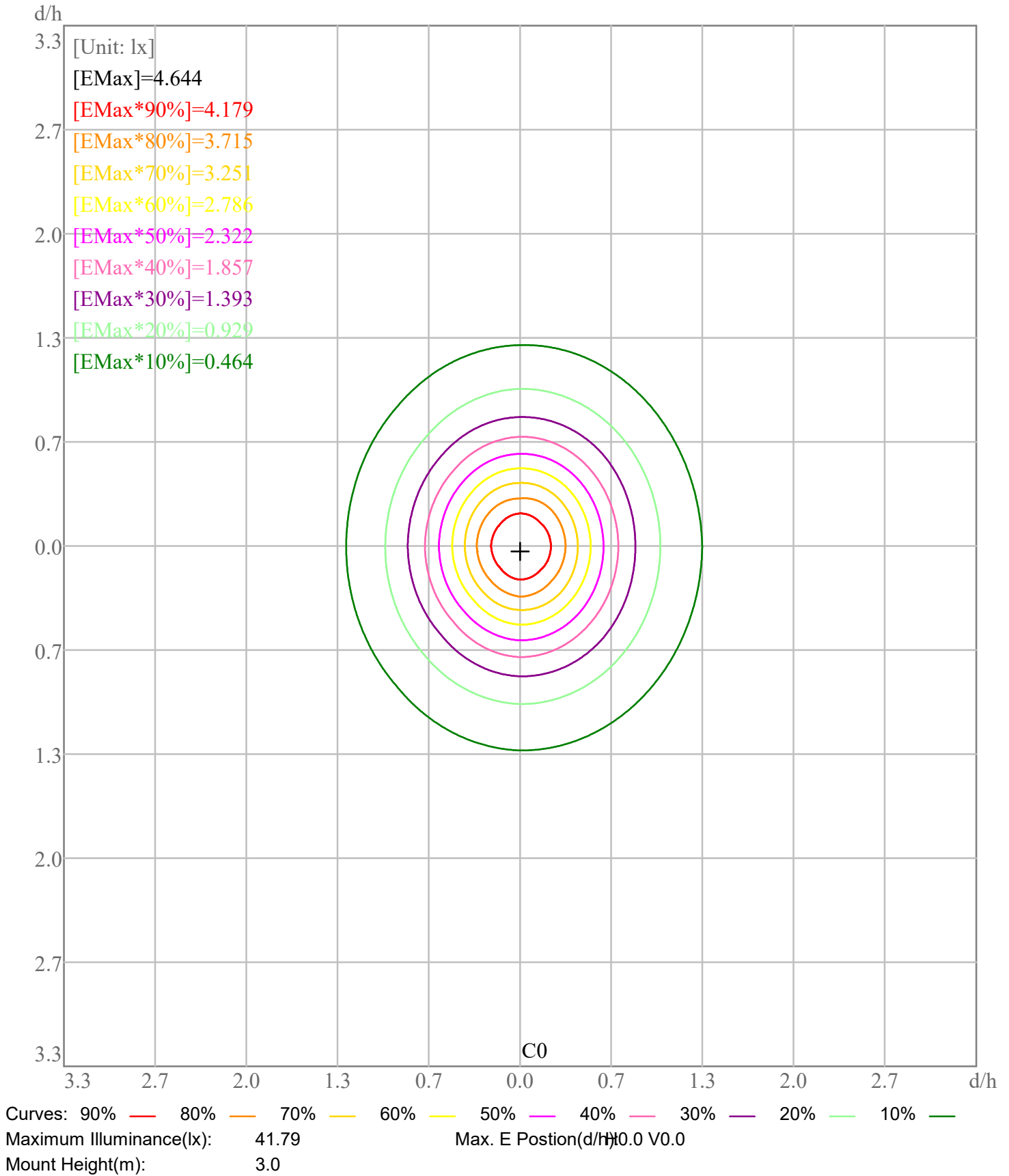

3D Plane ISO Illuminance Curve

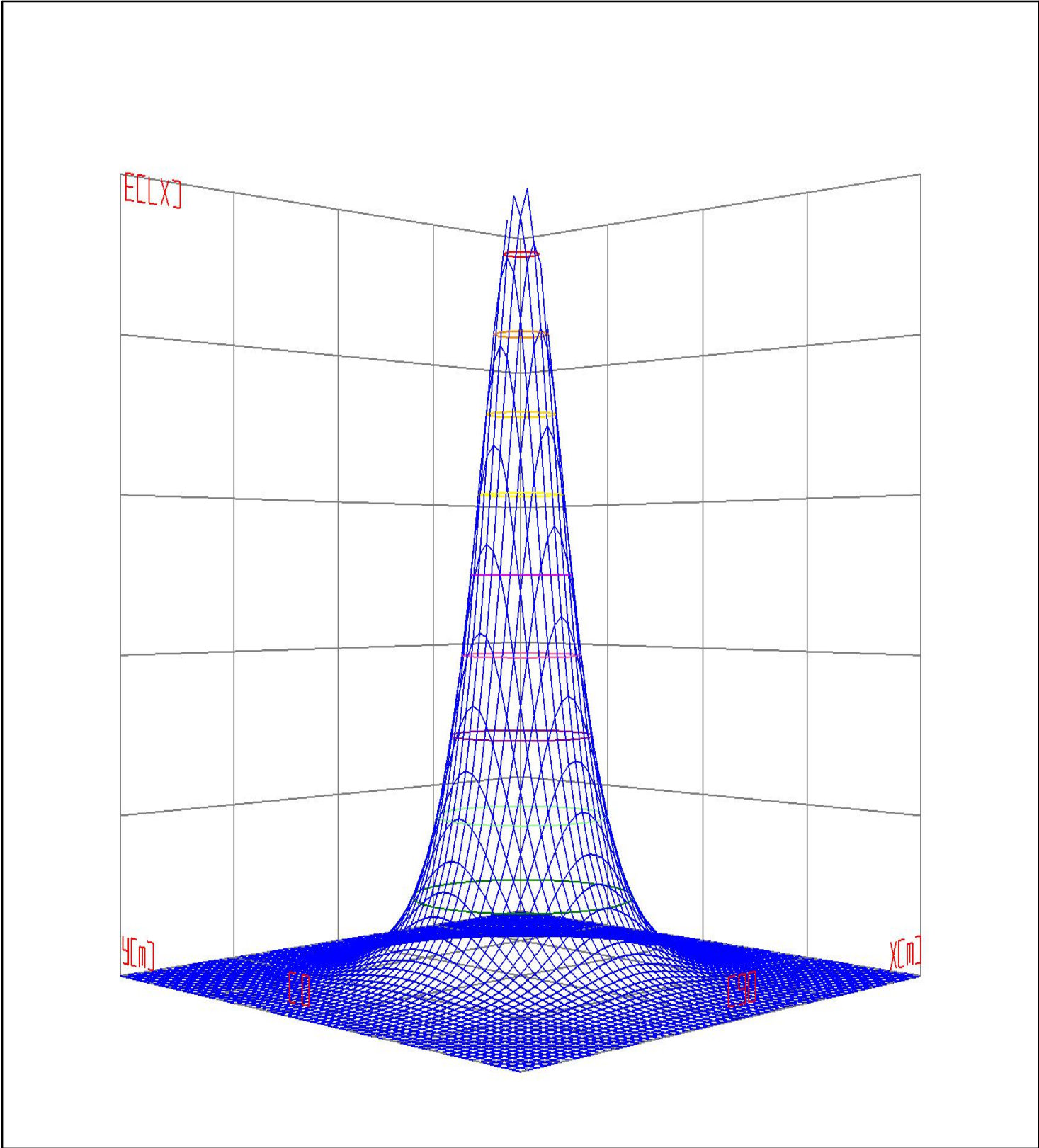

Curves: 3D Model — 90% — 80% — 70% — 60% — 50% — 40% — 30% — 20% — 10%
View Angles(deg): 0 Height(m): 3.0 Distance(m): 10.0

IES Indoor Report

Photometric Filename: TT-2835-L600-2700K-3-Milky LENS.IES

Space ISO Illuminance Curve

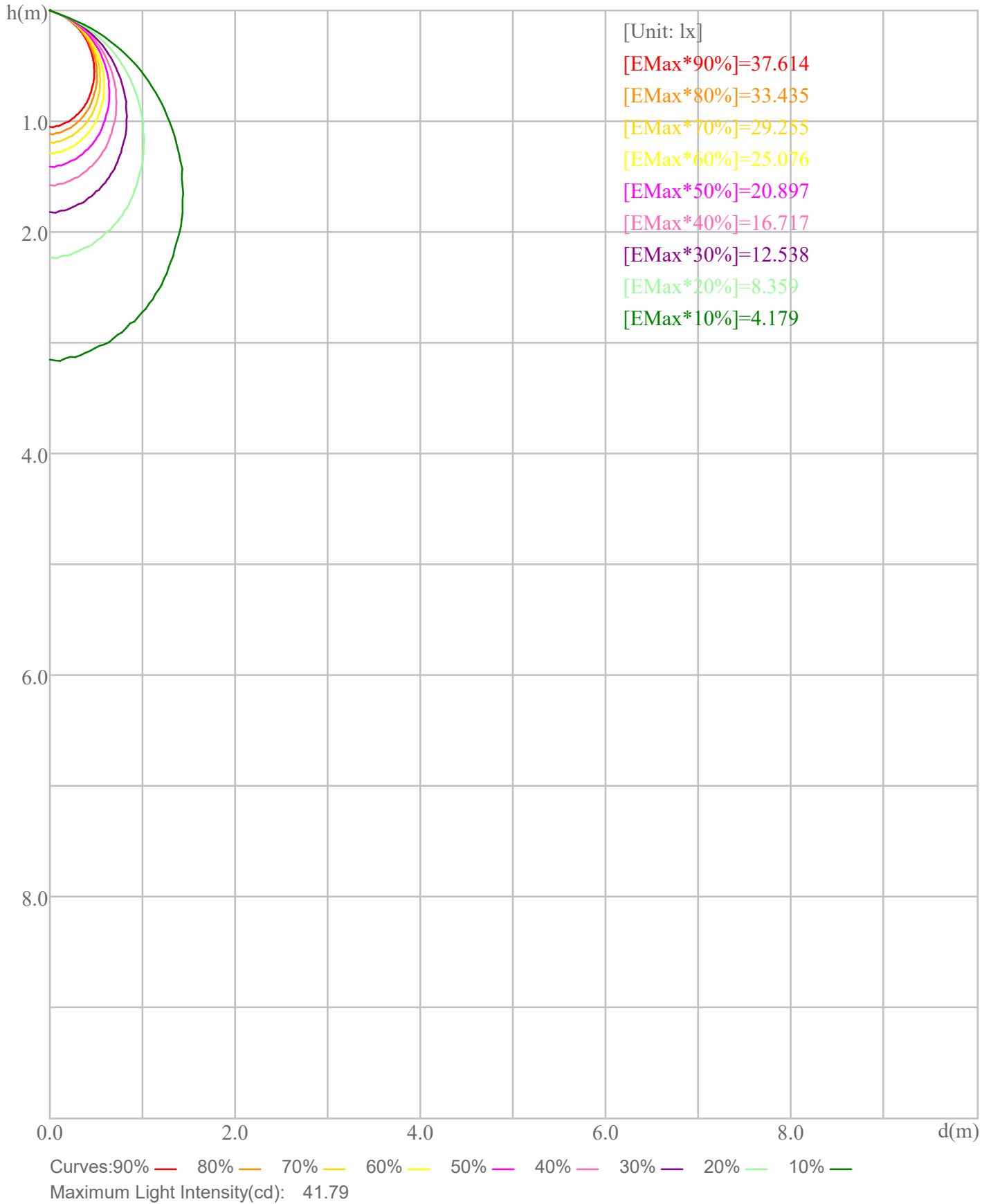

Illuminance-Distance Curve

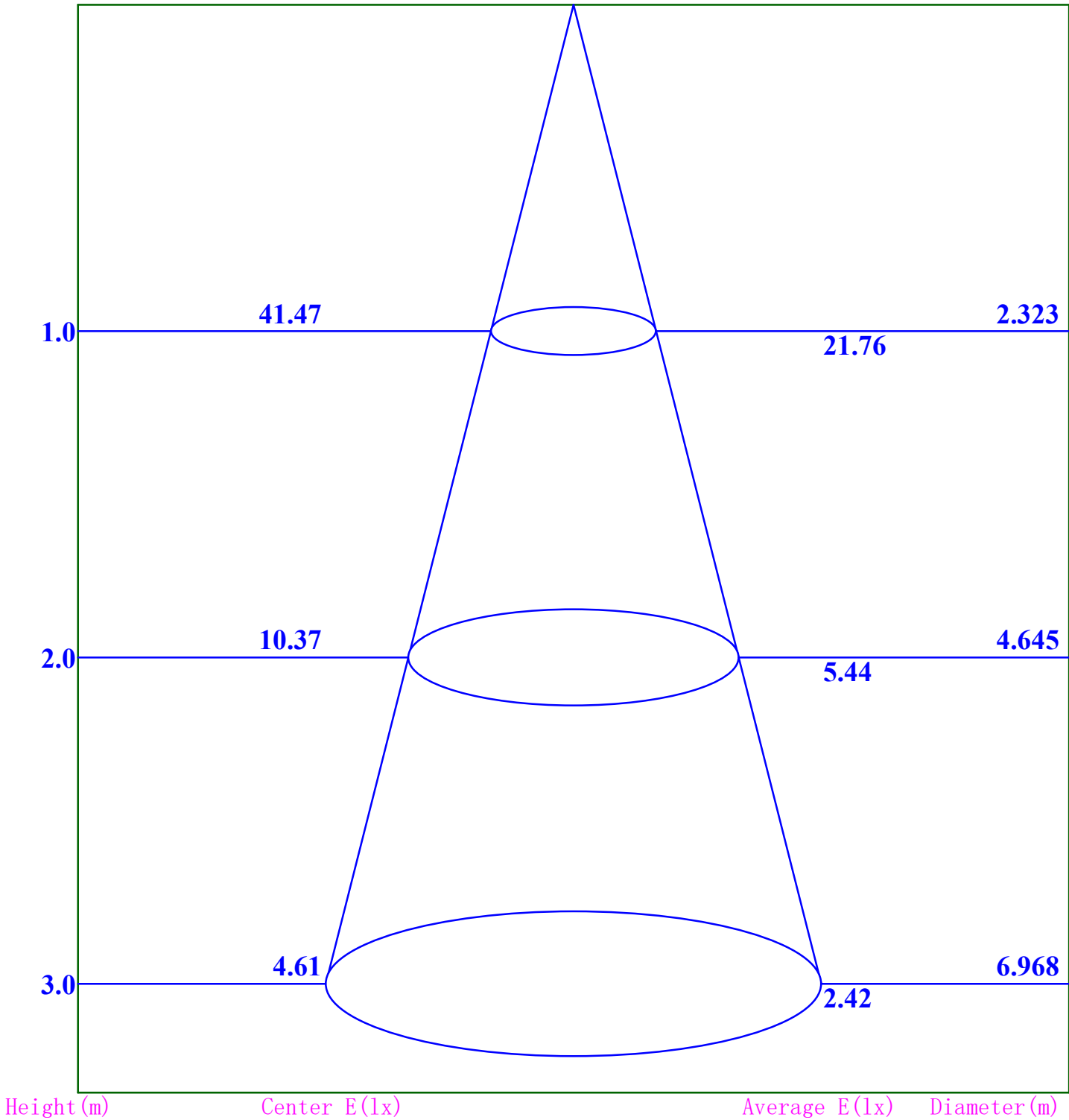

Beam Angle:98.5

IES Indoor Report

Photometric Filename: TT-2835-L600-2700K-3-Milky LENS.IES

Indoor Luminance Limiting Curve

Glare Grade Table

GI	Quality	Using Illuminance							
		a	b	c	d	e	f	g	h
1.15	A	2000	1000	500	<=300				
1.5	B		2000	1000	500	<=300			
1.85	C			2000	1000	500	<=300		
2.2	D				2000	1000	500	<=300	
2.55	E					2000	1000	500	<=300
		a	b	c	d	e	f	g	h

Luminance Table

Gama(deg)	45	50	55	60	65	70	75	80	85
C0	622	567	506	423	308	141	0	0	0
C90	646	616	575	511	426	272	36	0	0

Luminance Limiting Curve

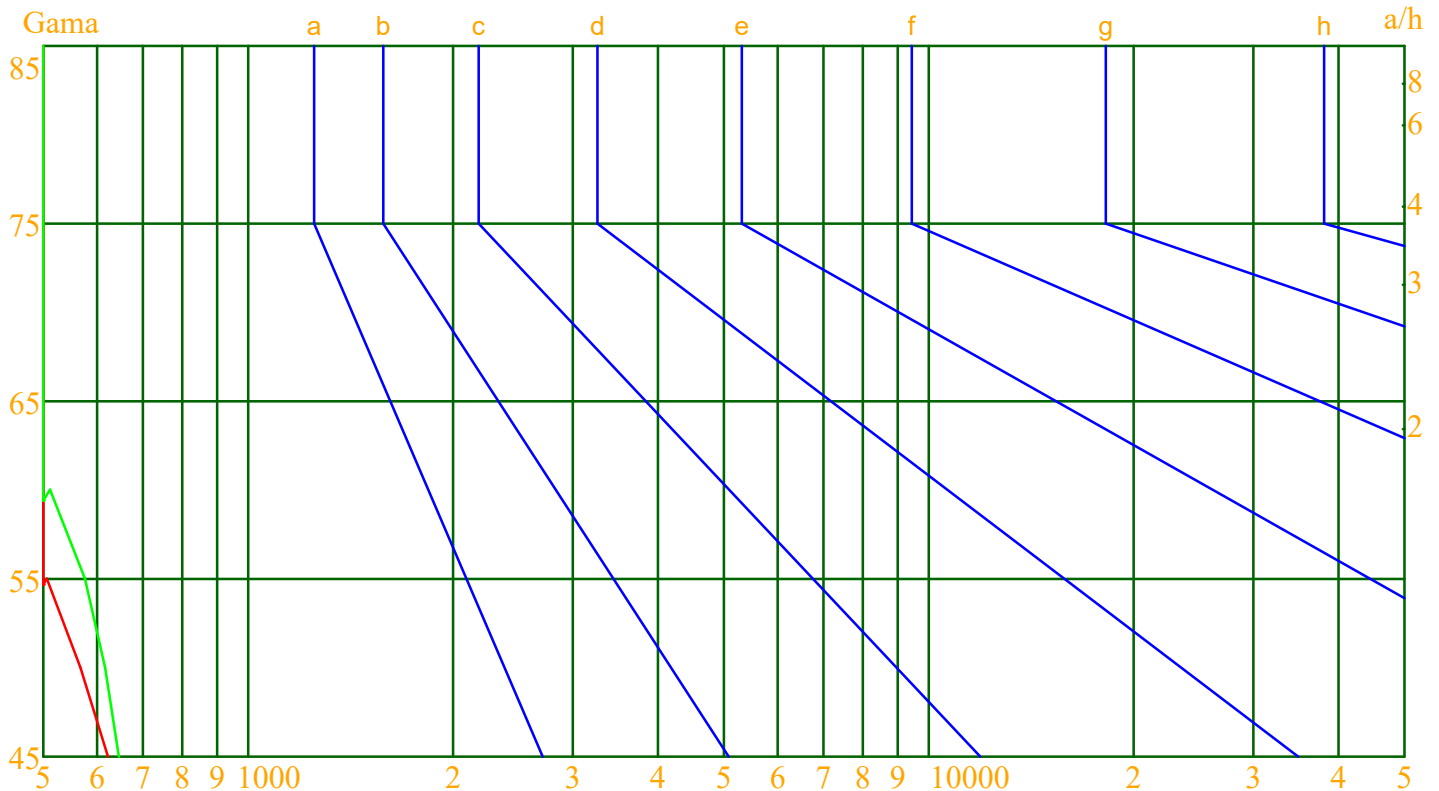

Luminous Size: Length(m)=0.304 Width(m)=0.120 Height(m)=0.060 Area(m²)=0.054720
 Luminous Type: Without Luminous Side
 Luminous Curves: C0-C180 Color: — C90-C270 Color: —

IES Indoor Report

Photometric Filename: TT-2835-L600-2700K-3-Milky LENS.IES

Indoor Budgetary Estimate Table

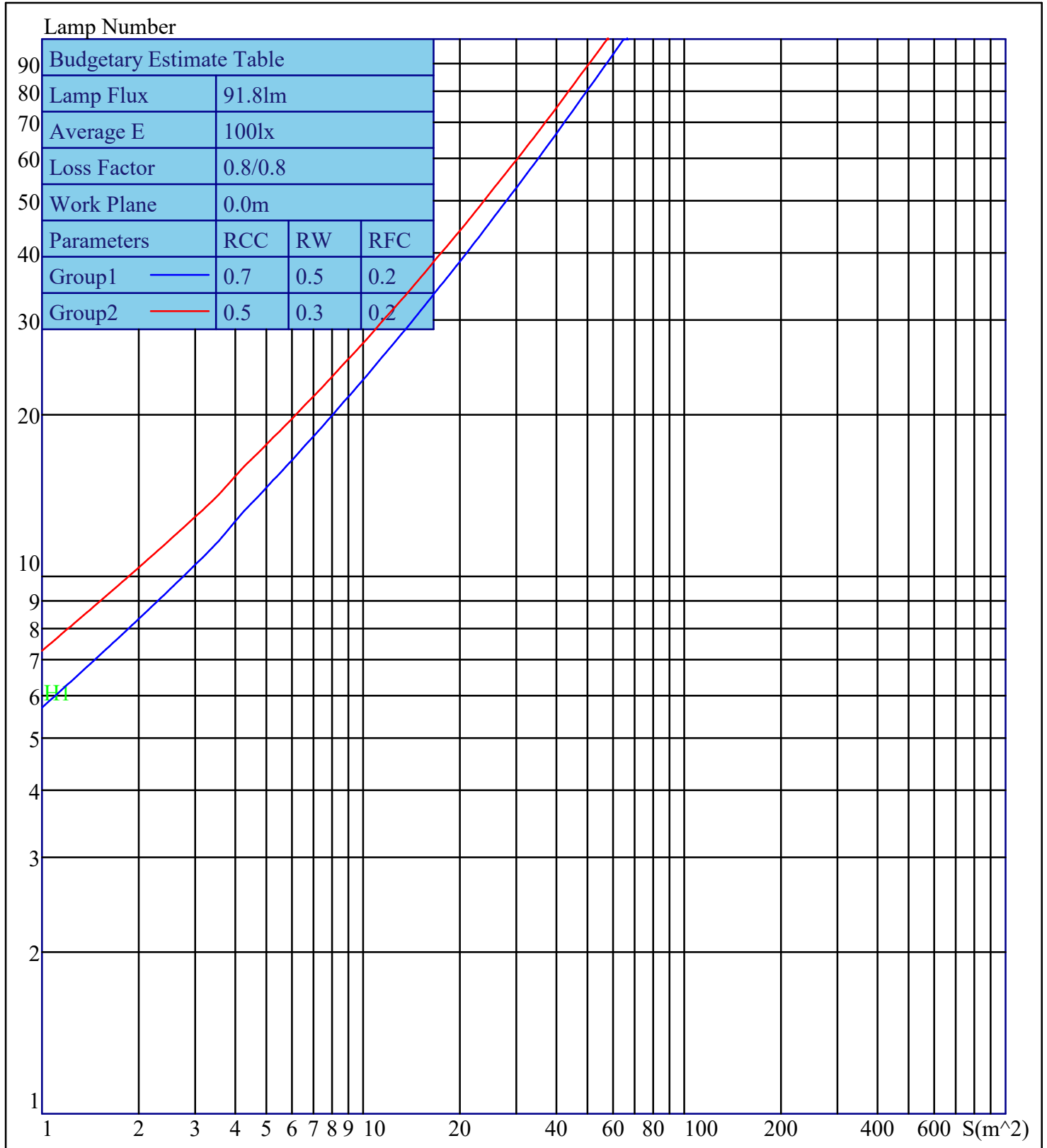

Parameters1: Rhocc = 0.7 Rhow = 0.5 Rhofc = 0.2 LLF = 0.8
 Parameters2: Rhocc = 0.5 Rhow = 0.3 Rhofc = 0.2 LLF = 0.8
 Average Illuminance(lx): 100 Cavity Height: H1(m) = 2