

TITANIUM

TECHNOLOGY

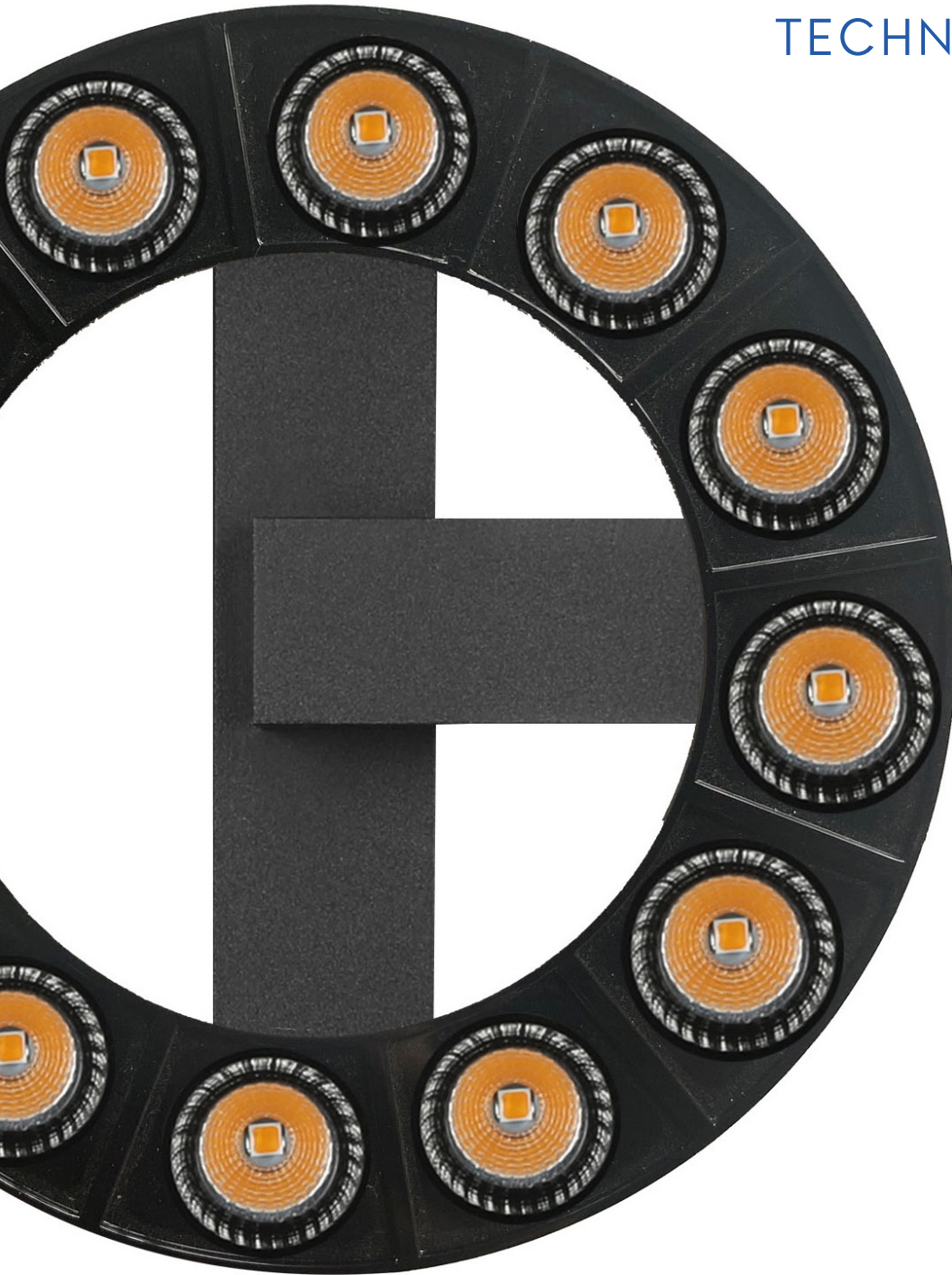

Track Lighting system
2024



TT-TRK-TRACK Page 9

Voltage (vDC)	Power (W/m)	Luminous flux (lm/m)	Angle beam (°)
24	-	-	-

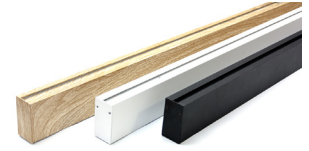

TT-TRK-TRACK-PL Page 10

Voltage (vDC)	Power (W/m)	Luminous flux (lm/m)	Angle beam (°)
24	-	-	-



TT-TRK-1X1 Page 11

Voltage (vDC)	Power (W/m)	Luminous flux (lm/m)	Angle beam (°)
24	2	120	34



TT-TRK-3X1 Page 12

Voltage (vDC)	Power (W/m)	Luminous flux (lm/m)	Angle beam (°)
24	4	380	34



TT-TRK-6X1 Page 13

Voltage (vDC)	Power (W/m)	Luminous flux (lm/m)	Angle beam (°)
24	8	790	34



TT-TRK-12X1 Page 14

Voltage (vDC)	Power (W/m)	Luminous flux (lm/m)	Angle beam (°)
24	16	1550	34



TT-TRK-3X1D Page 15

Voltage (vDC)	Power (W/m)	Luminous flux (lm/m)	Angle beam (°)
24	4	380	34



TT-TRK-6X1D Page 16

Voltage (vDC)	Power (W/m)	Luminous flux (lm/m)	Angle beam (°)
24	8	790	34



TT-TRK-12X1D Page 17

Voltage (vDC)	Power (W/m)	Luminous flux (lm/m)	Angle beam (°)
24	16	1550	34





TT-TRK-322 Page 18

Voltage (vDC)	Power (W/m)	Luminous flux (lm/m)	Angle beam (°)
24	13	980	120



TT-TRK-640 Page 19

Voltage (vDC)	Power (W/m)	Luminous flux (lm/m)	Angle beam (°)
24	26	1900	120



TT-TRK-958 Page 20

Voltage (vDC)	Power (W/m)	Luminous flux (lm/m)	Angle beam (°)
24	39	2850	120

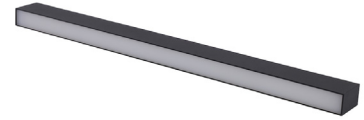

TT-TRK-84D Page 21

Voltage (vDC)	Power (W/m)	Luminous flux (lm/m)	Angle beam (°)
24	4	280	120



TT-TRK-164D Page 22

Voltage (vDC)	Power (W/m)	Luminous flux (lm/m)	Angle beam (°)
24	8	500	120



TT-TRK-323D Page 23

Voltage (vDC)	Power (W/m)	Luminous flux (lm/m)	Angle beam (°)
24	16	980	120



TT-TRK-BALL Page 24

Voltage (vDC)	Power (W/m)	Luminous flux (lm/m)	Angle beam (°)
24	5	290	360



TT-TRK-15 Page 25

Voltage (vDC)	Power (W/m)	Luminous flux (lm/m)	Angle beam (°)
24	8	380	120



TT-TRK-30 Page 26

Voltage (vDC)	Power (W/m)	Luminous flux (lm/m)	Angle beam (°)
24	16	880	120



TITANIUM

TECHNOLOGY



TT-TRK-5W-1 Page 27

Voltage (vDC)	Power (W/m)	Luminous flux (lm/m)	Angle beam (°)
24	5	440	40



TT-TRK-5W-2 Page 28

Voltage (vDC)	Power (W/m)	Luminous flux (lm/m)	Angle beam (°)
24	2 x 5W	880	40



TT-TRK-8W-1 Page 29

Voltage (vDC)	Power (W/m)	Luminous flux (lm/m)	Angle beam (°)
24	8	405	20



TT-TRK-10W-1 Page 30

Voltage (vDC)	Power (W/m)	Luminous flux (lm/m)	Angle beam (°)
24	10	780	24



TT-TRK-15W-1 Page 31

Voltage (vDC)	Power (W/m)	Luminous flux (lm/m)	Angle beam (°)
24	15	905	30



TT-TRK-20W-1 Page 32

Voltage (vDC)	Power (W/m)	Luminous flux (lm/m)	Angle beam (°)
24	20	1450	24



TT-TRK-10W-1Z Page 33

Voltage (vDC)	Power (W/m)	Luminous flux (lm/m)	Angle beam (°)
24	10	780	200



TT-TRK-120C Page 34

Voltage (vDC)	Power (W/m)	Luminous flux (lm/m)	Angle beam (°)
24	12	650	Diffuse



TT-TRK-164C Page 35

Voltage (vDC)	Power (W/m)	Luminous flux (lm/m)	Angle beam (°)
24	12	650	Diffuse





TT-TRK-12X1W-C Page 36

Voltage (vDC)	Power (W/m)	Luminous flux (lm/m)	Angle beam (°)
24	12	1150	34



TT-TRK-18X1W-C Page 37

Voltage (vDC)	Power (W/m)	Luminous flux (lm/m)	Angle beam (°)
24	18	1750	34



TT-TRK-SUSP-BALL Page 38

Voltage (vDC)	Power (W/m)	Luminous flux (lm/m)	Angle beam (°)
24	5	290	-



TT-TRK-SUSP-8W Page 39

Voltage (vDC)	Power (W/m)	Luminous flux (lm/m)	Angle beam (°)
24	8	405	24



TT-TRK-SUSP-5W Page 40

Voltage (vDC)	Power (W/m)	Luminous flux (lm/m)	Angle beam (°)
24	5	450	30



TT-TRK-SUSP-5W-10 Page 41

Voltage (vDC)	Power (W/m)	Luminous flux (lm/m)	Angle beam (°)
24	5	450	30





TT-TRK-SUSP-10W Page 42

Voltage (vDC)	Power (W/m)	Luminous flux (lm/m)	Angle beam (°)
24	10	780	36



TT-TRK-SUSP-CONE Page 43

Voltage (vDC)	Power (W/m)	Luminous flux (lm/m)	Angle beam (°)
24	10	480	Diffuse



TT-TRK-TRACK-R Page 44

Voltage (vDC)	Power (W/m)	Luminous flux (lm/m)	Angle beam (°)
24	200 max.	-	-



TT-TRK-TRACK-R1/2 Page 45

Voltage (vDC)	Power (W/m)	Luminous flux (lm/m)	Angle beam (°)
24	200 max.	-	-



TT-TRK-TRACK-R1/4 Page 46

Voltage (vDC)	Power (W/m)	Luminous flux (lm/m)	Angle beam (°)
24	200 max.	-	-



TT-TRK-TRACK-R1/8 Page 47

Voltage (vDC)	Power (W/m)	Luminous flux (lm/m)	Angle beam (°)
24	200 max.	-	-



TT-TRK-8W-1R Page 48

Voltage (vDC)	Power (W/m)	Luminous flux (lm/m)	Angle beam (°)
24	8	405	30





TT-TRK-SUSP-10W-R Page 49

Voltage (vDC)	Power (W/m)	Luminous flux (lm/m)	Angle beam (°)
24	10	780	36



TT-TRK-15W-1R Page 50

Voltage (vDC)	Power (W/m)	Luminous flux (lm/m)	Angle beam (°)
24	15	905	30



TT-TRK-6X1R Page 51

Voltage (vDC)	Power (W/m)	Luminous flux (lm/m)	Angle beam (°)
24	8	790	34



TT-TRK-163R Page 52

Voltage (vDC)	Power (W/m)	Luminous flux (lm/m)	Angle beam (°)
24	8	500	Diffuse

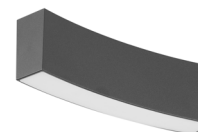

TT-TRK-5W-1R Page 53

Voltage (vDC)	Power (W/m)	Luminous flux (lm/m)	Angle beam (°)
24	5	440	90



TT-TRK-10W-1R Page 54

Voltage (vDC)	Power (W/m)	Luminous flux (lm/m)	Angle beam (°)
24	10	780	24



TT-TRK-BALL-R Page 55

Voltage (vDC)	Power (W/m)	Luminous flux (lm/m)	Angle beam (°)
24	5	290	220



TITANIUM

TECHNOLOGY

TT-TRK-TRACK



Voltage	24vDC	
Size	1000mm x 40mm x 76mm	3000mm x 40mm x 76mm
	39 ³ / ₈ " x 1 ⁹ / ₁₆ " x 3"	118 ¹ / ₄ " x 1 ⁹ / ₁₆ " x 3"
Cut hole	40mm 1 ⁹ / ₁₆ "	
Finish	BK - Black	
	WH - White	
	WOOD - Wood	
IP	20	

PRODUCT CODE

TT	-	TYPE	-	MODEL	-	FINISH
TT	-	TRK	-	TRACK	-	BK
TT	-	TRK	-	TRACK	-	

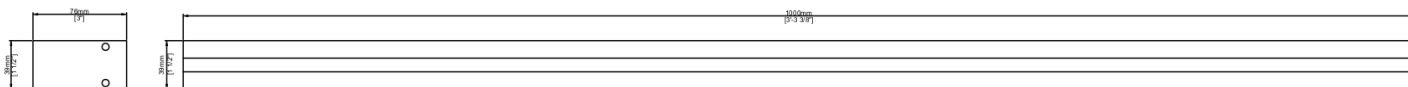

TITANIUM

TECHNOLOGY

TT-TRK-TRACK-PL

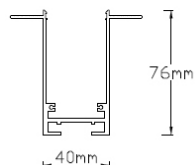
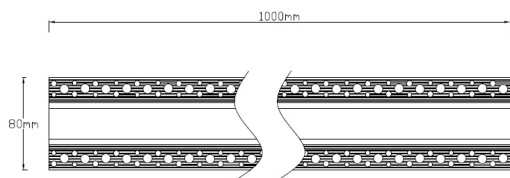
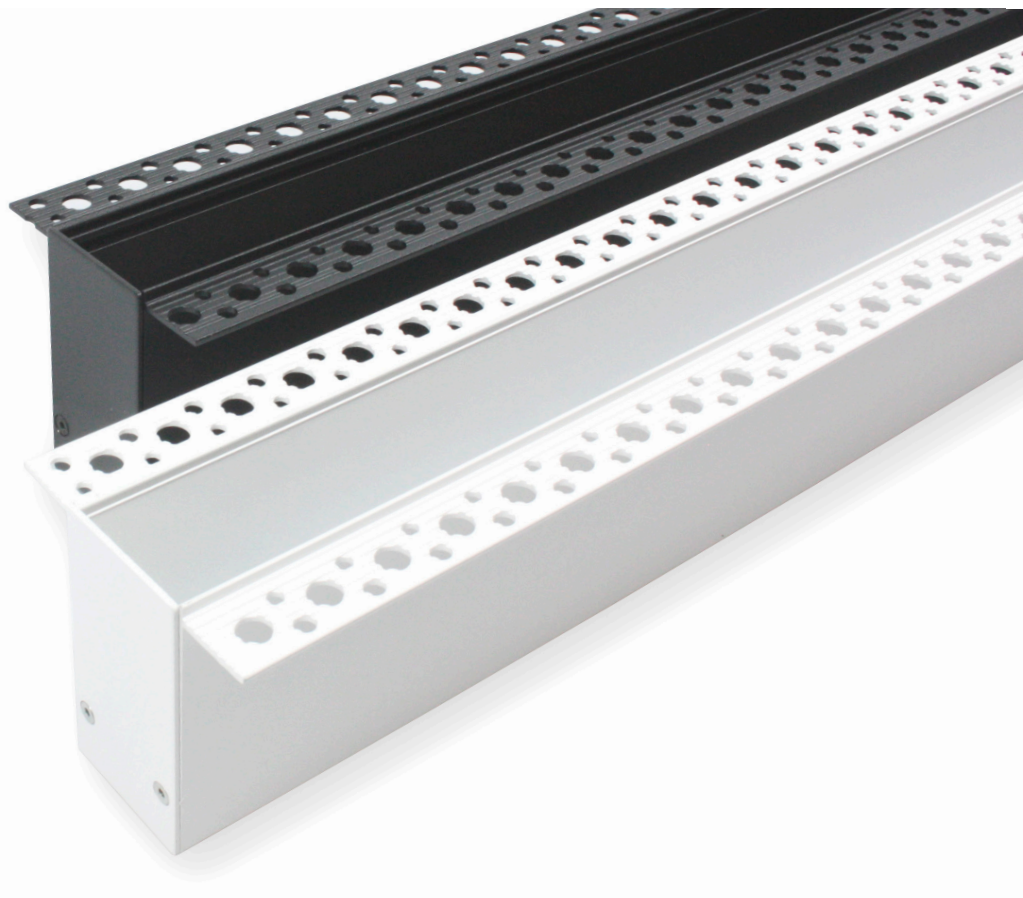

Voltage	24vDC
Size	1000mm x 40mm x 76mm 39 ³ / ₈ " x 1 ⁹ / ₁₆ " x 3"
Cut hole	40mm 1 ⁹ / ₁₆ "
Finish	WH - White BK - Black
IP	20

PRODUCT CODE

TT	-	TYPE	-	MODEL	-	UTILITY	-	FINISH
TT	-	TRK	-	TRACK	-	PL	-	BK
TT	-	TRK	-	TRACK	-	PL	-	

TITANIUM

TECHNOLOGY

TT-TRK-1X1

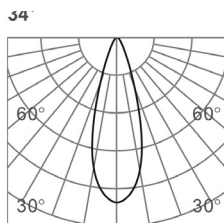
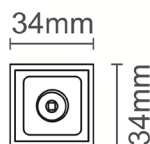
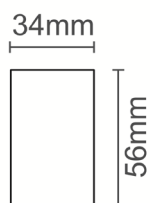
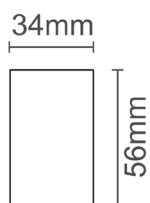

h(m)	E(lx)	Φ(m)
1	429	Φ0.71
2	107	Φ1.43
3	47	Φ2.15
4	26	Φ2.87
5	17	Φ3.59

Voltage	24vDC
Amperage	0,09A
Power LED	2,16W
Lumens	120 lm
CRI	90
Angle	34°
LED Color	27K - Warm white 2700K 30K - Warm white 3000K 40K - Neutral white 4000K
Dimmable	Yes
Size	34 x 34 x 56 mm 1 ⁵ / ₁₆ " x 1 ⁵ / ₁₆ " x 2 ³ / ₁₆ "
Finish	BK - Black WH - White
IP	20

PRODUCT CODE

TT	-	TYPE	-	MODEL	-	FINISH	-	LED COLOR
TT	-	TRK	-	1X1	-	BK	-	27K
TT	-	TRK	-	1X1	-		-	

TITANIUM

TECHNOLOGY

TT-TRK-3X1

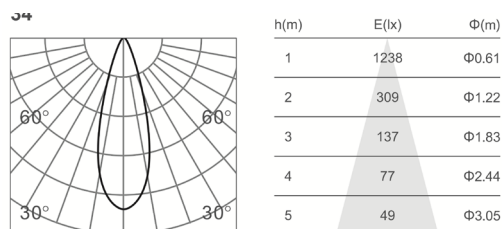
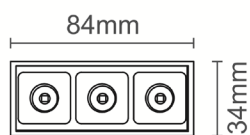
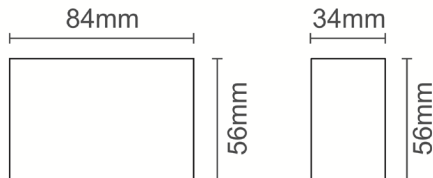

Voltage	24vDC
Amperage	0,19A
Power LED	4,56W
Lumens	380 lm
CRI	90
Angle	34°
LED Color	27K - Warm white 2700K 30K - Warm white 3000K 40K - Neutral white 4000K 50K - Cold white 5000K
Dimmable	Yes
Size	84 x 34 x 56 mm 3 ¹ / ₄ " x 1 ⁵ / ₁₆ " x 2 ³ / ₁₆ "
Finish	BK - Black WH - White
IP	20

PRODUCT CODE

TT	-	TYPE	-	MODEL	-	FINISH	-	LED COLOR
TT	-	TRK	-	3X1	-	BK	-	27K
TT	-	TRK	-	3X1	-		-	

TITANIUM

TECHNOLOGY

TT-TRK-6X1

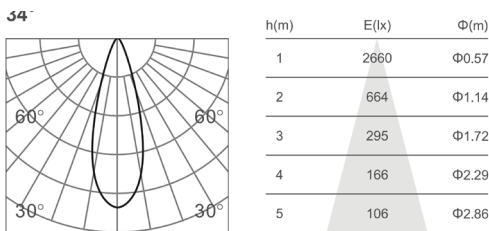
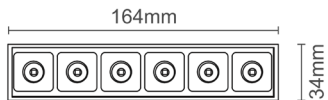
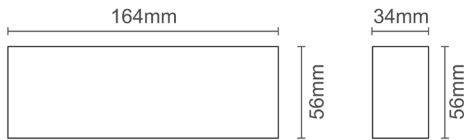

PRODUCT CODE

TT	-	TYPE	-	MODEL	-	FINISH	-	LED COLOR
TT	-	TRK	-	6X1	-	BK	-	27K
TT	-	TRK	-	6X1	-		-	

Voltage	24vDC
Amperage	0,36A
Power LED	8,64W
Lumens	790 lm
CRI	90
Angle	34°
LED Color	27K - Warm white 2700K 30K - Warm white 3000K 40K - Neutral white 4000K 50K - Cold white 5000K
Dimmable	Yes
Size	164 x 34 x 56 mm 6 ⁷ / ₁₆ x 1 ⁵ / ₁₆ " x 2 ³ / ₁₆ "
Finish	BK - Black WH - White
IP	20

TITANIUM

TECHNOLOGY

TT-TRK-12X1

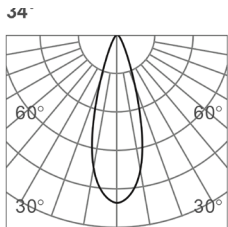
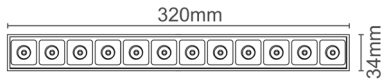
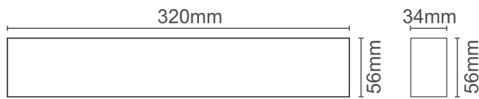

h(m)	E(lx)	Φ(m)
1	5127	Φ0.55
2	1282	Φ1.11
3	569	Φ1.67
4	320	Φ2.23
5	205	Φ2.78

Voltage	24vDC
Amperage	0,72A
Power LED	17,28W
Lumens	1550 lm
CRI	90
Angle	34°
LED Color	27K - Warm white 2700K 30K - Warm white 3000K 40K - Neutral white 4000K 50K - Cold white 5000K
Dimmable	Yes
Size	320 x 34 x 56 mm 12 ¹ / ₂ x 1 ⁵ / ₁₆ " x 2 ³ / ₁₆ "
Finish	BK - Black WH - White
IP	20

PRODUCT CODE

TT	-	TYPE	-	MODEL	-	FINISH	-	LED COLOR
TT	-	TRK	-	12X1	-	BK	-	27K
TT	-	TRK	-	12X1	-		-	

TITANIUM

TECHNOLOGY

TT-TRK-3X1D

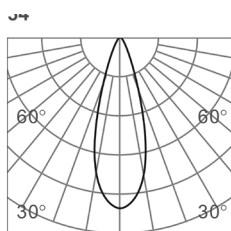
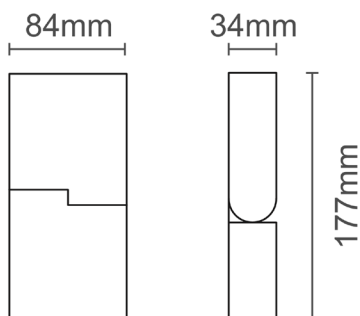

h(m)	E(lx)	Φ(m)
1	1238	Φ0.61
2	309	Φ1.22
3	137	Φ1.83
4	77	Φ2.44
5	49	Φ3.05

Voltage	24vDC
Amperage	0,19A
Power LED	4,56W
Lumens	380 lm
CRI	90
Angle	34°
LED Color	27K - Warm white 2700K 30K - Warm white 3000K 40K - Neutral white 4000K 50K - Cold white 5000K
Dimmable	Yes
Size	84 x 34 x 177 mm 3 1/4" x 1 5/16" x 7"
Finish	BK - Black WH - White
IP	20

PRODUCT CODE

TT	-	TYPE	-	MODEL	-	FINISH	-	LED COLOR
TT	-	TRK	-	3X1D	-	BK	-	27K
TT	-	TRK	-	3X1D	-		-	

TITANIUM

TECHNOLOGY

TT-TRK-6X1D

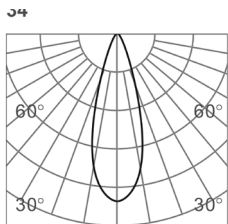
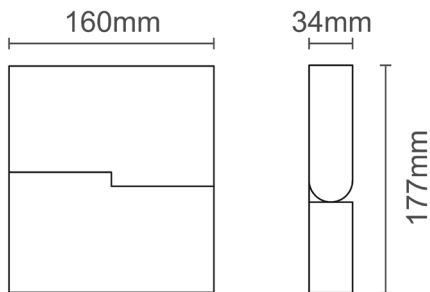

h(m)	E(lx)	Φ(m)
1	2660	Φ0.57
2	664	Φ1.14
3	295	Φ1.72
4	166	Φ2.29
5	106	Φ2.86

Voltage	24vDC
Amperage	0,36A
Power LED	8,64W
Lumens	790 lm
CRI	90
Angle	34°
LED Color	27K - Warm white 2700K 30K - Warm white 3000K 40K - Neutral white 4000K 50K - Cold white 5000K
Dimmable	Yes
Size	160 x 34 x 177 mm 6 ¹ / ₄ " x 1 ³ / ₈ " x 7"
Finish	BK - Black WH - White
IP	20

PRODUCT CODE

TT	-	TYPE	-	MODEL	-	FINISH	-	LED COLOR
TT	-	TRK	-	6X1D	-	BK	-	27K
TT	-	TRK	-	6X1D	-		-	

TITANIUM

TECHNOLOGY

TT-TRK-12X1D

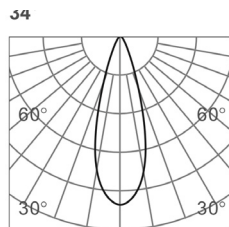
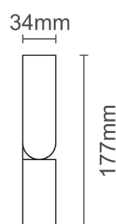
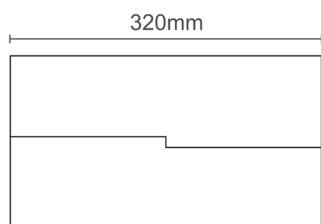

h(m)	E(lx)	Φ(m)
1	5127	Φ0.55
2	1282	Φ1.11
3	569	Φ1.67
4	320	Φ2.23
5	205	Φ2.78

Voltage	24vDC
Amperage	0,72A
Power LED	17,28W
Lumens	1550 lm
CRI	90
Angle	34°
LED Color	27K - Warm white 2700K 30K - Warm white 3000K 40K - Neutral white 4000K 50K - Cold white 5000K
Dimmable	Yes
Size	320 x 34 x 177 mm 12 ¹ / ₂ " x 1 ⁵ / ₁₆ " x 7"
Finish	BK - Black WH - White
IP	20

PRODUCT CODE

TT	-	TYPE	-	MODEL	-	FINISH	-	LED COLOR
TT	-	TRK	-	12X1D	-	BK	-	27K
TT	-	TRK	-	12X1D	-		-	

TITANIUM

TECHNOLOGY

TT-TRK-322

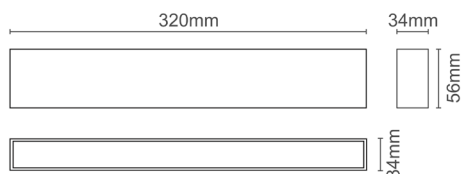

Diffuse

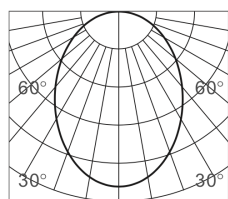

h(m)	E(lx)	Φ(m)
1	426	Φ2.51
2	106	Φ5.02
3	47	Φ7.53
4	26	Φ10.04
5	17	Φ12.55

Voltage	24vDC
Amperage	0,7A
Power LED	16,8W
Lumens	980 lm
CRI	90
Angle	120°
LED Color	27K - Warm white 2700K 30K - Warm white 3000K 40K - Neutral white 4000K 50K - Cold white 5000K
Dimmable	Yes
Size	320 x 34 x 56 mm 12 ⁵ / ₈ " x 1 ⁵ / ₁₆ " x 2 ³ / ₁₆ "
Finish	BK - Black WH - White
IP	20

PRODUCT CODE

TT	-	TYPE	-	MODEL	-	FINISH	-	LED COLOR
TT	-	TRK	-	322	-	BK	-	27K
TT	-	TRK	-	322	-		-	

TITANIUM

TECHNOLOGY

TT-TRK-640

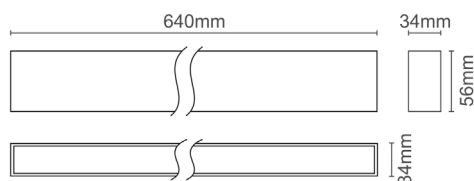

Diffuse

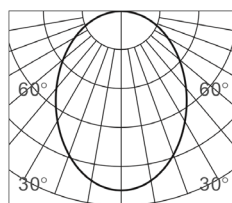

h(m)	E(lx)	Φ(m)
1	479	Φ2.65
2	119	Φ5.30
3	53	Φ7.95
4	29	Φ10.60
5	19	Φ13.25

PRODUCT CODE

TT	-	TYPE	-	MODEL	-	FINISH	-	LED COLOR
TT	-	TRK	-	640	-	BK	-	27K
TT	-	TRK	-	640	-		-	

Voltage	24vDC
Amperage	1,08A
Power LED	26W
Lumens	1900 lm
CRI	90
Angle	120°
LED Color	27K - Warm white 2700K 30K - Warm white 3000K 40K - Neutral white 4000K 50K - Cold white 5000K
Dimmable	Yes
Size	640 x 34 x 56 mm 25 ¹ / ₄ " x 1 ⁵ / ₁₆ " x 2 ³ / ₁₆ "
Finish	BK - Black WH - White
IP	20

TITANIUM

TECHNOLOGY

TT-TRK-958

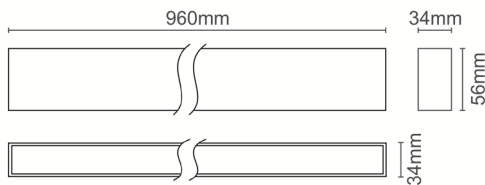
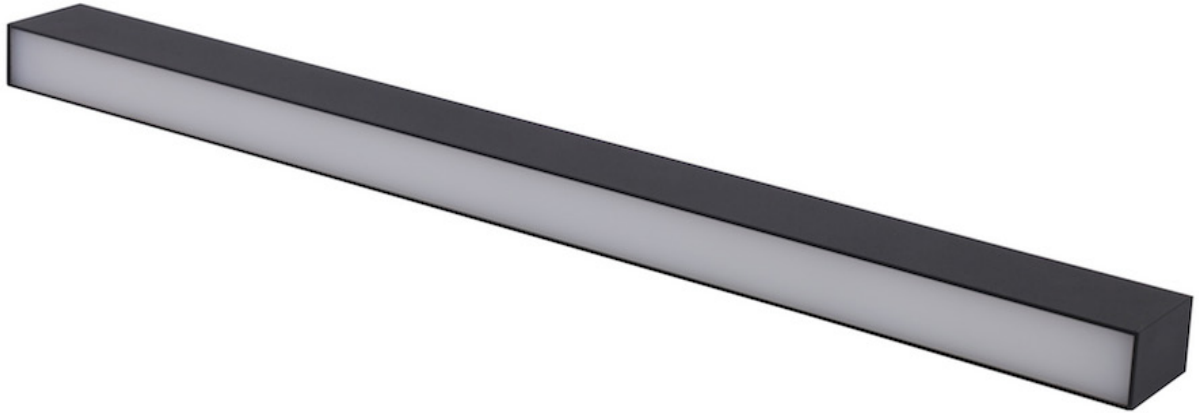

Diffuse

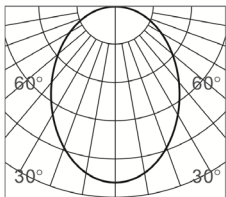

h(m)	E(lx)	Φ(m)
1	889	Φ2.23
2	222	Φ4.46
3	98	Φ6.69
4	55	Φ8.92
5	35	Φ11.15

Voltage 24vDC

Amperage 1,625A

Power LED 39W

Lumens 2850 lm

CRI 90

Angle 120°

LED Color
27K - Warm white 2700K
30K - Warm white 3000K
40K - Neutral white 4000K
50K - Cold white 5000K

Dimmable Yes

Size 960 x 34 x 56 mm
 37¹³/₁₆" x 1⁵/₁₆" x 2³/₁₆"

Finish **BK** - Black
WH - White

IP 20

PRODUCT CODE

TT	-	TYPE	-	MODEL	-	FINISH	-	LED COLOR
TT	-	TRK	-	958	-	BK	-	27K
TT	-	TRK	-	958	-		-	

TITANIUM

TECHNOLOGY

TT-TRK-84D

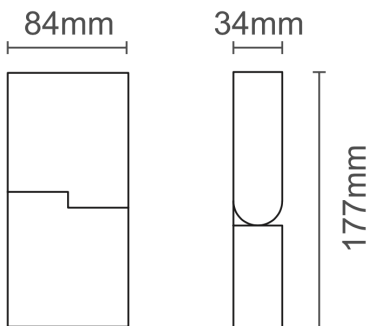

Diffuse

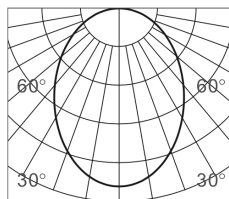

h(m)	E(lx)	Φ(m)
1	105.5	Φ2.60
2	26.3	Φ5.20
3	11.7	Φ7.80
4	6.5	Φ10.40
5	4.2	Φ13.00

PRODUCT CODE

TT	-	TYPE	-	MODEL	-	FINISH	-	LED COLOR
TT	-	TRK	-	84D	-	BK	-	27K
TT	-	TRK	-	84D	-		-	

Voltage	24vDC
Amperage	0,18A
Power LED	4,32W
Lumens	280 lm
CRI	90
Angle	120°
LED Color	27K - Warm white 2700K 30K - Warm white 3000K 40K - Neutral white 4000K 50K - Cold white 5000K
Dimmable	Yes
Size	84 x 34 x 177 mm 3 ¹ / ₄ " x 1 ⁵ / ₁₆ " x 6 ¹⁵ / ₁₆ "
Finish	BK - Black WH - White
IP	20

TITANIUM

TECHNOLOGY

TT-TRK-164D

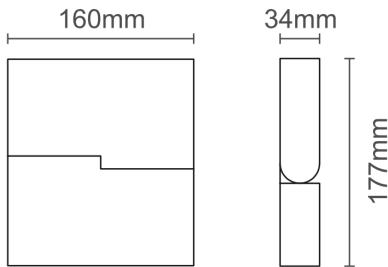

Diffuse

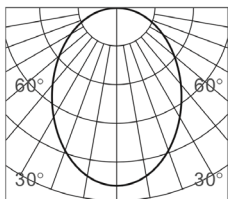

h(m)	E(lx)	Φ(m)
1	236	Φ2.59
2	59	Φ5.19
3	26	Φ7.79
4	14	Φ10.39
5	9	Φ12.99

Voltage	24vDC
Amperage	0,36A
Power LED	8,64W
Lumens	500 lm
CRI	90
Angle	120°
LED Color	27K - Warm white 2700K 30K - Warm white 3000K 40K - Neutral white 4000K 50K - Cold white 5000K
Dimmable	Yes
Size	160 x 34 x 177 mm 6 ⁵ / ₁₆ " x 1 ⁵ / ₁₆ " x 6 ¹⁵ / ₁₆ "
Finish	BK - Black WH - White
IP	20

PRODUCT CODE

TT	-	TYPE	-	MODEL	-	FINISH	-	LED COLOR
TT	-	TRK	-	164D	-	BK	-	27K
TT	-	TRK	-	164D	-		-	

TITANIUM

TECHNOLOGY

TT-TRK-323D

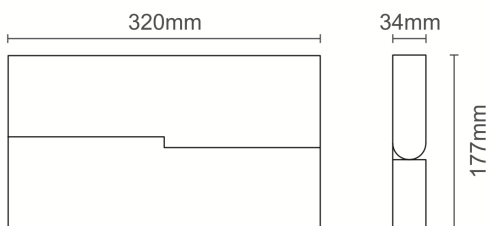

Diffuse

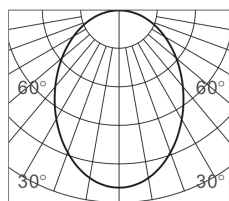

h(m)	E(lx)	Φ(m)
1	234	Φ2.47
2	58	Φ4.95
3	26	Φ7.43
4	14	Φ9.90
5	9	Φ12.38

PRODUCT CODE

TT	-	TYPE	-	MODEL	-	FINISH	-	LED COLOR
TT	-	TRK	-	323D	-	BK	-	27K
TT	-	TRK	-	323D	-		-	

Voltage 24vDC

Amperage 0,7A

Power LED 16,8W

Lumens 980 lm

CRI 90

Angle 120°

LED Color
27K - Warm white 2700K
30K - Warm white 3000K
40K - Neutral white 4000K
50K - Cold white 5000K

Dimmable Yes

Size 320 x 34 x 177 mm
 12⁵/₈" x 1⁵/₁₆" x 6¹⁵/₁₆"

Finish **BK** - Black
WH - White

IP 20

TITANIUM

TECHNOLOGY

TT-TRK-BALL

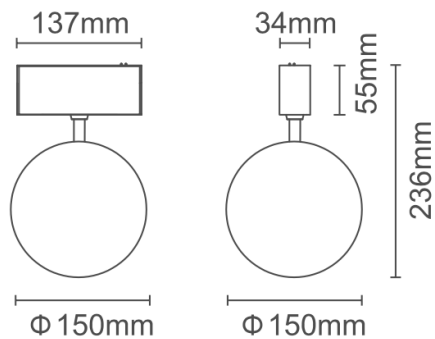

Diffuse

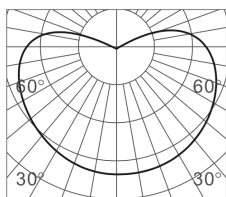

h(m)	E(lx)	Φ(m)
1	24	Φ2
2	6	Φ4
3	2	Φ6
4	1	Φ8
5	0.9	Φ10

PRODUCT CODE

TT - TYPE - FORM - FINISH - LED COLOR

TT	-	TRK	-	BALL	-	BK	-	27K
TT	-	TRK	-	BALL	-		-	

Voltage 24vDC

Amperage 0,30A

Power LED 7,2W

Lumens 290 lm

CRI 90

Angle 360°

LED Color
27K - Warm white 2700K
30K - Warm white 3000K
40K - Neutral white 4000K
50K - Cold white 5000K

Dimmable Yes

Size 137 x 34 x 55 mm Ø140mm
 5³/₈ " x 1⁵/₁₆ " x 2³/₁₆ " Ø5¹/₂ "

Finish **BK** - Black
WH - White

IP 20

TITANIUM

TECHNOLOGY

TT-TRK-15

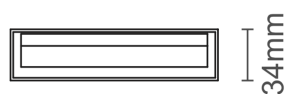
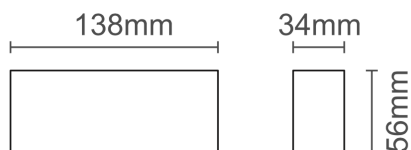

Wallwasher

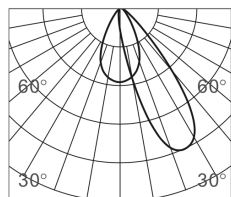

h(m)	E(lx)	Φ(m)
1	137	Φ0.97
2	34	Φ1.94
3	15	Φ2.91
4	8	Φ3.88
5	5	Φ4.85

PRODUCT CODE

TT	-	TYPE	-	MODEL	-	FINISH	-	LED COLOR
TT	-	TRK	-	15	-	BK	-	27K
TT	-	TRK	-	15	-		-	

Voltage	24vDC
Amperage	0,29A
Power LED	6,96W
Lumens	380 lm
CRI	90
Angle	120°
LED Color	27K - Warm white 2700K 30K - Warm white 3000K 40K - Neutral white 4000K 50K - Cold white 5000K
Dimmable	Yes
Size	138 x 34 x 56 mm 5 ⁷ / ₁₆ " x 1 ⁵ / ₁₆ " x 2 ³ / ₁₆ "
Finish	BK - Black WH - White
IP	20

TITANIUM

TECHNOLOGY

TT-TRK-30

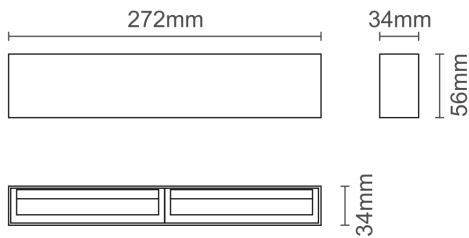

Wallwasher

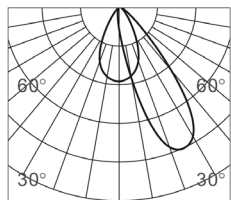

h(m)	E(lx)	Φ(m)
1	344	Φ0.90
2	86	Φ1.80
3	38	Φ2.70
4	21	Φ3.59
5	13	Φ4.49

PRODUCT CODE

TT	-	TYPE	-	MODEL	-	FINISH	-	LED COLOR
TT	-	TRK	-	30	-	BK	-	27K
TT	-	TRK	-	3X1	-		-	

Voltage 24vDC

Amperage 0,58A

Power LED 13,92W

Lumens 880 lm

CRI 90

Angle 120°

LED Color
27K - Warm white 2700K
30K - Warm white 3000K
40K - Neutral white 4000K
50K - Cold white 5000K

Dimmable Yes

Size 272 x 34 x 56 mm
 10^{11/16}" x 1^{5/16}" x 2^{3/16}"

Finish **BK** - Black
WH - White

IP 20

TITANIUM

TECHNOLOGY

TT-TRK-5W-1

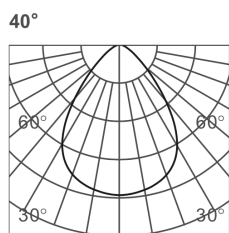
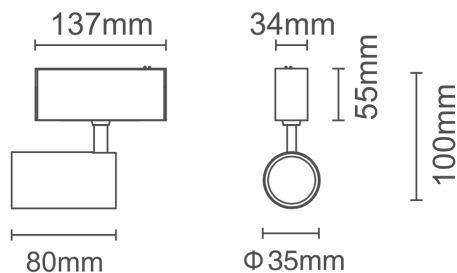

h(m)	E lx	Φ(m)
2	278	Φ0.96
3	124	Φ1.44
3.5	91	Φ1.68
4	69	Φ1.92
5	44	Φ2.40

Voltage	24vDC
Amperage	0,24A
Power LED	5,76W
Lumens	440 lm
CRI	90
Angle	40°
LED Color	27K - Warm white 2700K 30K - Warm white 3000K 40K - Neutral white 4000K 50K - Cold white 5000K
Dimmable	Yes
Size	Ø35 x 80 mm Ø1 ³ / ₈ " x 3 ¹ / ₈ "
Finish	BK - Black WH - White
IP	20

PRODUCT CODE

TT	TYPE	POWER	PROJECTOR	FINISH	LED COLOR
TT	TRK	5W	1	BK	27K
TT	TRK	5W	1		

TITANIUM

TECHNOLOGY

TT-TRK-5W-2

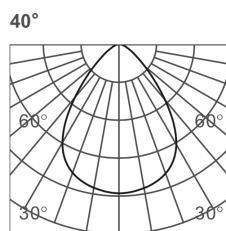
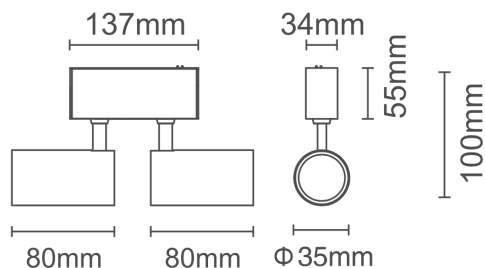

h(m)	E(lx)	Φ(m)
2	278	Φ0.96
3	124	Φ1.44
3.5	91	Φ1.68
4	69	Φ1.92
5	44	Φ2.40

Voltage	24vDC
Amperage	0,48A
Power LED	11,52W
Lumens	880 lm
CRI	90
Angle	40°
LED Color	27K - Warm white 2700K 30K - Warm white 3000K 40K - Neutral white 4000K 50K - Cold white 5000K
Dimmable	Yes
Size	2 x Ø35 x 80 mm 2 x Ø1 ³ / ₈ " x 3 ¹ / ₈ "
Finish	BK - Black WH - White
IP	20

PRODUCT CODE

TT	-	TYPE	-	POWER	-	PROJECTOR	-	FINISH	-	LED COLOR
TT	-	TRK	-	5W	-	2	-	BK	-	27K
TT	-	TRK	-	5W	-	2	-		-	

TITANIUM

TECHNOLOGY

TT-TRK-8W-1

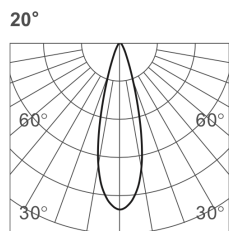
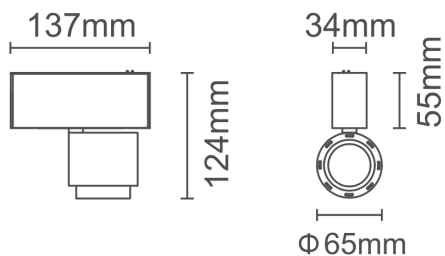

h(m)	E(lx)	Φ(m)
1	2675	Φ0.26
2	668	Φ0.53
3	297	Φ0.80
4	167	Φ1.06
5	107	Φ1.33

Voltage	24vDC
Amperage	0,36A
Power LED	8,64W
Lumens	405 lm
CRI	90
Angle	20°
LED Color	27K - Warm white 2700K 30K - Warm white 3000K 40K - Neutral white 4000K 50K - Cold white 5000K
Dimmable	Yes
Size	Ø65 mm Ø2 1/2"
Finish	BK - Black WH - White
IP	20

PRODUCT CODE

TT	TYPE	POWER	PROJECTOR	FINISH	LED COLOR
TT	TRK	8W	1	BK	27K
TT	TRK	8W	1		

TITANIUM

TECHNOLOGY

TT-TRK-10W-1

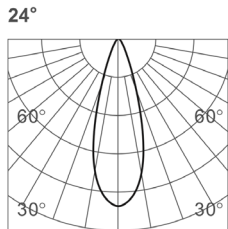
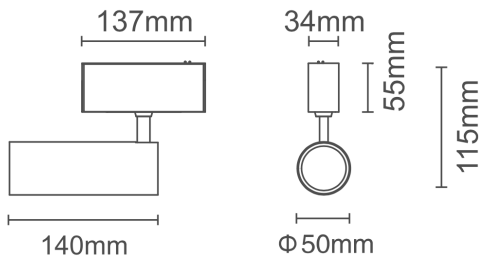

h(m)	E(lx)	Φ(m)
1	3857	Φ0.40
2	964	Φ0.81
3	428	Φ1.22
4	241	Φ1.62
5	154	Φ2.03

Voltage 24vDC

Amperage 0,44A

Power LED 10,56W

Lumens 780 lm

CRI 90

Angle 24°

LED Color
27K - Warm white 2700K
30K - Warm white 3000K
40K - Neutral white 4000K
50K - Cold white 5000K

Dimmable Yes

Size
 Ø50 x 140 mm
 Ø2" x 5 1/2"

Finish
BK - Black
WH - White

IP 20

PRODUCT CODE

TT	-	TYPE	-	POWER	-	PROJECTOR	-	FINISH	-	LED COLOR
TT	-	TRK	-	10W	-	1	-	BK	-	27K
TT	-	TRK	-	10W	-	1	-		-	

TITANIUM

TECHNOLOGY

TT-TRK-15W-1

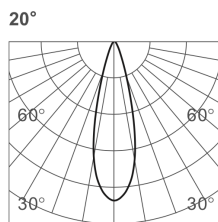
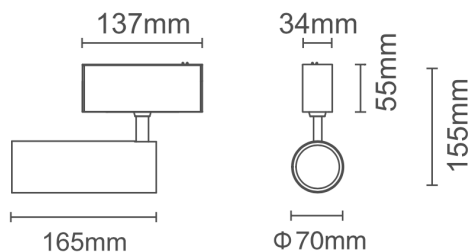

h(m)	E(lx)	Φ(m)
1	4847	Φ0.30
2	1212	Φ0.60
3	538	Φ0.90
4	302	Φ1.20
5	193	Φ1.51

Voltage	24vDC
Amperage	0,68A
Power LED	16,32W
Lumens	905 lm
CRI	90
Angle	30°
LED Color	27K - Warm white 2700K 30K - Warm white 3000K 40K - Neutral white 4000K 50K - Cold white 5000K
Dimmable	Yes
Size	Ø92 mm Ø3 ⁵ / ₈ "
Finish	BK - Black WH - White
IP	20

PRODUCT CODE

TT	TYPE	POWER	PROJECTOR	FINISH	LED COLOR
TT	TRK	15W	1	BK	27K
TT	TRK	15W	1		

TITANIUM

TECHNOLOGY

TT-TRK-20W-1

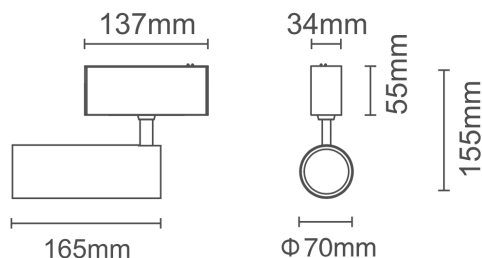

24°

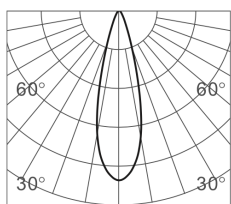

h(m)	E(lx)	Φ(m)
1	5787	Φ0.47
2	1447	Φ0.95
3	643	Φ1.42
4	361	Φ1.90
5	231	Φ2.37

Voltage 24vDC

Amperage 0,9A

Power LED 21,6W

Lumens 1450 lm

CRI 90

Angle 24°

LED Color
27K - Warm white 2700K
30K - Warm white 3000K
40K - Neutral white 4000K
50K - Cold white 5000K

Dimmable Yes

Size
 Ø70 x 165 mm
 Ø2³/₄" x 6¹/₂"

Finish
BK - Black
WH - White

IP 20

PRODUCT CODE

TT	-	TYPE	-	POWER	-	PROJECTOR	-	FINISH	-	LED COLOR
TT	-	TRK	-	20W	-	1	-	BK	-	27K
TT	-	TRK	-	20W	-	1	-		-	

TITANIUM

TECHNOLOGY

TT-TRK-10W-1Z

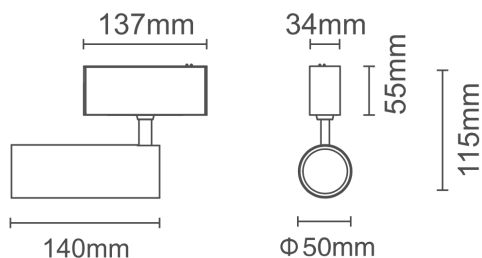

Voltage	24vDC
Amperage	0,43A
Power LED	10,32W
Lumens	780 lm
CRI	90
Angle	10° to 50°
LED Color	27K - Warm white 2700K 30K - Warm white 3000K 40K - Neutral white 4000K 50K - Cold white 5000K
Dimmable	Yes
Size	Ø50 x 140 mm Ø2" x 5½"
Finish	BK - Black WH - White
IP	20

PRODUCT CODE

TT	TYPE	POWER	PROJECTOR	FINISH	LED COLOR
TT	TRK	10W	1Z	BK	27K
TT	TRK	10W	1Z		

TITANIUM

TECHNOLOGY

TT-TRK-120-C

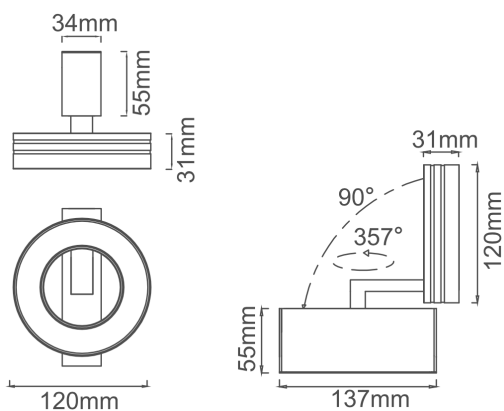
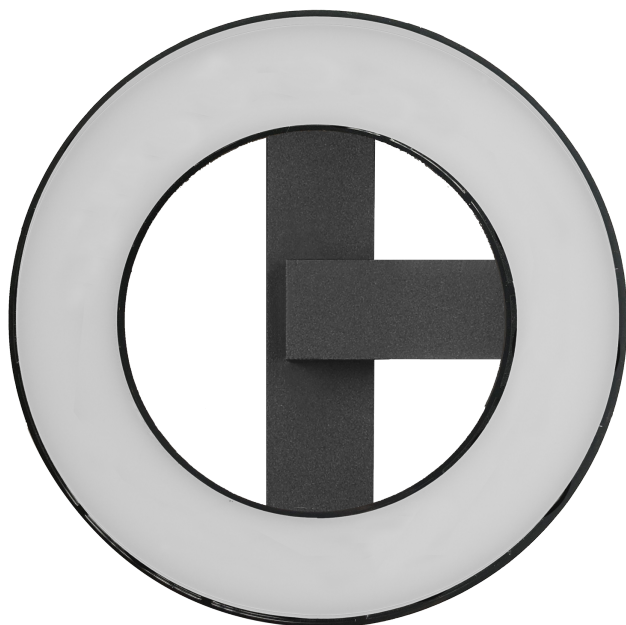

Voltage 24vDC

Amperage 0,5A

Power LED 12W

Lumens 650 lm

CRI 90

Angle Diffuse

LED Color
27K - Warm white 2700K
30K - Warm white 3000K
40K - Neutral white 4000K
50K - Cold white 5000K

Dimmable Yes

Size 137 mm x 34 mm x 56 mm x Ø120 mm
 $5\frac{3}{8}'' \times 1\frac{3}{8}'' \times 2\frac{3}{16}'' \times \text{Ø}4\frac{3}{4}''$

Finish **BK** - Black
WH - White

IP 20

PRODUCT CODE

TT	TYPE	MODEL	CURVE	FINISH	LED COLOR
TT	TRK	120	C	BK	27K
TT	TRK	120	C		

TITANIUM

TECHNOLOGY

TT-TRK-164-C

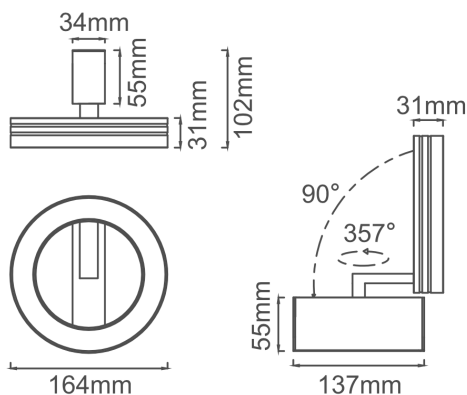

Voltage	24vDC
Amperage	0,75A
Power LED	18W
Lumens	650 lm
CRI	90
Angle	Diffuse
LED Color	27K - Warm white 2700K 30K - Warm white 3000K 40K - Neutral white 4000K 50K - Cold white 5000K
Dimmable	Yes
Size	137 mm x 34 mm x 55 mm x Ø164 mm 5 ³ / ₈ " x 1 ³ / ₈ " x 2 ³ / ₁₆ " x Ø6 ⁷ / ₁₆ "
Finish	BK - Black WH - White
IP	20

PRODUCT CODE

TT	TYPE	MODEL	CURVE	FINISH	LED COLOR
TT	TRK	164	C	BK	27K
TT	TRK	164	C		

TITANIUM

TECHNOLOGY

TT-TRK-12X1W-C

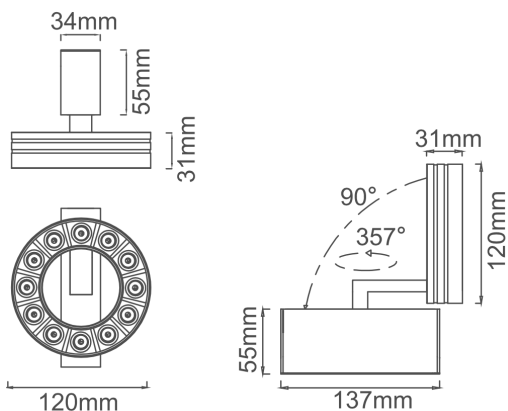
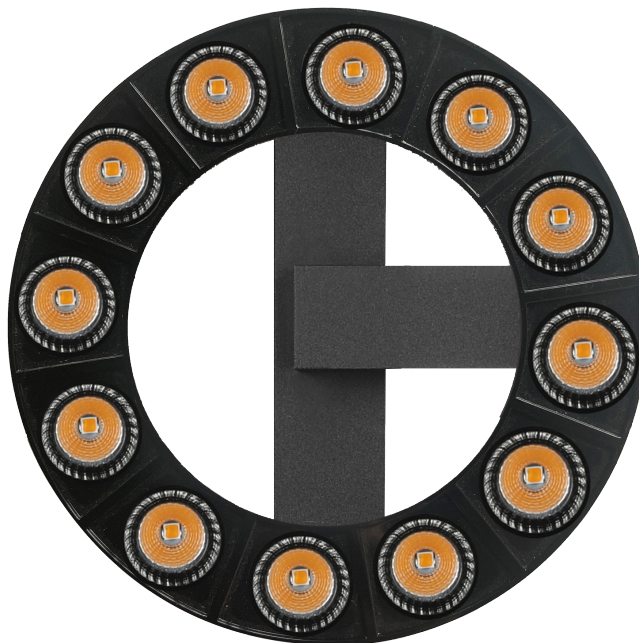

Voltage	24vDC
Amperage	0,52A
Power LED	12,48W
Lumens	1150 lm
CRI	90
Angle	34°
LED Color	27K - Warm white 2700K 30K - Warm white 3000K 40K - Neutral white 4000K 50K - Cold white 5000K
Dimmable	Yes
Size	137 mm x 34 mm x 55 mm x Ø120 mm 5 ³ / ₈ " x 1 ³ / ₈ " x 2 ³ / ₁₆ " x Ø4 ³ / ₄ "
Finish	BK - Black WH - White
IP	20

PRODUCT CODE

TT	TYPE	POWER	CURVE	FINISH	LED COLOR
TT	TRK	12X1W	C	BK	27K
TT	TRK	12X1W	C		

TITANIUM

TECHNOLOGY

TT-TRK-18X1W-C

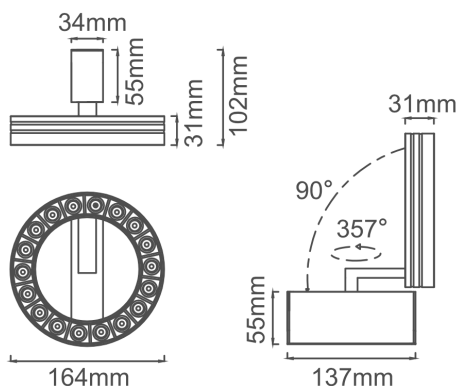

Voltage	24vDC
Amperage	0,75A
Power LED	18W
Lumens	1750 lm
CRI	90
Angle	34°
LED Color	27K - Warm white 2700K 30K - Warm white 3000K 40K - Neutral white 4000K 50K - Cold white 5000K
Dimmable	Yes
Size	137 mm x 34 mm x 55 mm x Ø164 mm 5 ³ / ₈ " x 1 ³ / ₈ " x 2 ³ / ₁₆ " x Ø6 ⁷ / ₁₆ "
Finish	BK - Black WH - White
IP	20

PRODUCT CODE

TT	TYPE	POWER	CURVE	FINISH	LED COLOR
TT	TRK	18X1W	C	BK	27K
TT	TRK	18X1W	C		

TITANIUM

TECHNOLOGY

TT-TRK-SUSP-BALL

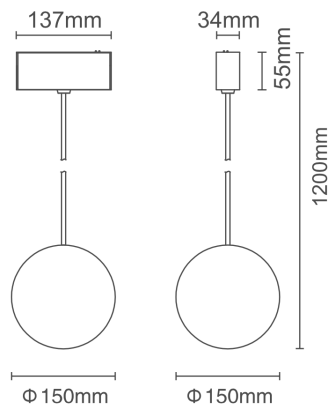

Diffuse

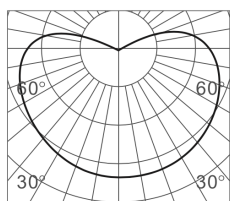

h(m)	E(lx)	Φ(m)
1	24	Φ2
2	6	Φ4
3	2	Φ6
4	1	Φ8
5	0.9	Φ10

Voltage 24vDC

Amperage 0,30A

Power LED 7,2W

Lumens 290 lm

CRI 90

LED Color
27K - Warm white 2700K
30K - Warm white 3000K
40K - Neutral white 4000K
50K - Cold white 5000K

Dimmable Yes

Size 137 x 34 x 55 mm Ø1200mm
 5³/₈ " x 1⁵/₁₆ " x 2³/₁₆ " x Ø47¹/₄ "

Finish **BK** - Black
WH - White

IP 20

PRODUCT CODE

TT	-	TYPE	-	MODEL	-	FORM	-	FINISH	-	LED COLOR
TT	-	TRK	-	SUSP	-	BALL	-	BK	-	27K
TT	-	TRK	-	SUSP	-	BALL	-		-	

TITANIUM

TECHNOLOGY

TT-TRK-SUSP-8W

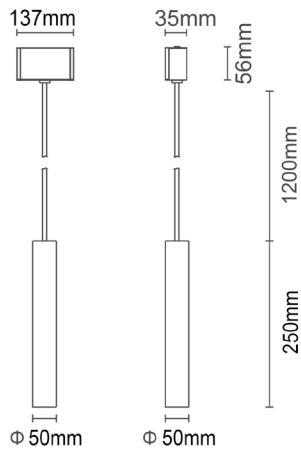

Voltage	24vDC
Amperage	0,33A
Power LED	8W
Lumens	405 lm
CRI	90
Angle	24°
LED Color	27K - Warm white 2700K 30K - Warm white 3000K 40K - Neutral white 4000K 50K -Cold white 5000K
Dimmable	Yes
Size	Ø50 x 250 mm Ø2" x 9 ⁷ / ₈ "
Finish	BK - Black WH - White
IP	20

PRODUCT CODE

TT	TYPE	MODEL	POWER	FINISH	LED COLOR
TT	TRK	SUSP	8W	BK	27K
TT	TRK	SUSP	8W		

TITANIUM

TECHNOLOGY

TT-TRK-SUSP-5W

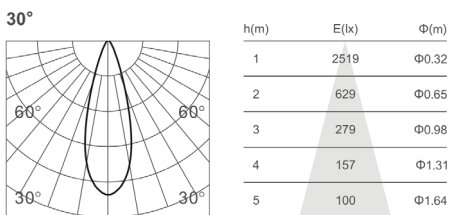
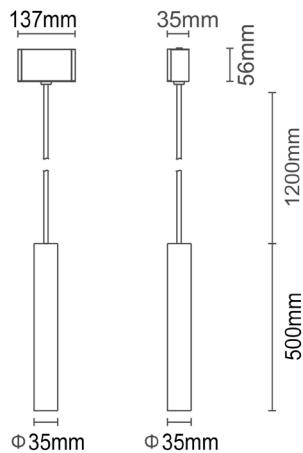

PRODUCT CODE

TT	-	TYPE	-	MODEL	-	POWER	-	FINISH	-	LED COLOR
TT	-	TRK	-	SUSP	-	5W	-	BK	-	27K
TT	-	TRK	-	SUSP	-	5W	-		-	

Voltage 24vDC

Amperage 0,29A

Power LED 6,96W

Lumens 450 lm

CRI 90

Angle 30°

LED Color
27K - Warm white 2700K
30K - Warm white 3000K
40K - Neutral white 4000K
50K - Cold white 5000K

Dimmable Yes

Size
 Ø35 mm x 500mm
 Ø3⁵/₈" x 19¹¹/₁₆"

Finish
BK - Black
WH - White

IP 20

TITANIUM

TECHNOLOGY

TT-TRK-SUSP-5W-10



Voltage	24vDC
Amperage	0,29A
Power LED	6,96W
Lumens	450 lm
CRI	90
Angle	30°
LED Color	27K - Warm white 2700K 30K - Warm white 3000K 40K - Neutral white 4000K 50K - Cold white 5000K
Acrylic length (cm)	10 20 30 40
Dimmable	Yes
Size	Ø35 mm x 500mm Ø3 ⁵ / ₈ " x 19 ¹¹ / ₁₆ "
Finish	BK - Black WH - White
IP	20

PRODUCT CODE

TT	-	TYPE	-	MODEL	-	POWER	-	ACRYLIC LENGTH (CM)	-	FINISH	-	LED COLOR
TT	-	TRK	-	SUSP	-	5W	-	10	-	BK	-	27K
TT	-	TRK	-	SUSP	-	5W	-		-		-	

TITANIUM

TECHNOLOGY

TT-TRK-SUSP-10W

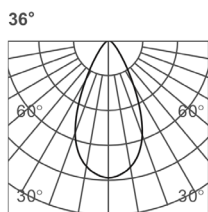
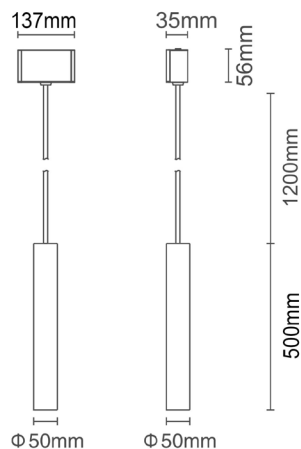

h(m)	E(x)	Φ(m)
1	2154	Φ0.64
2	538	Φ1.28
3	239	Φ1.92
4	134	Φ2.56
5	86	Φ3.21

Voltage	24vDC
Amperage	0,46A
Power LED	11,04W
Lumens	780 lm
CRI	90
Angle	36°
LED Color	27K - Warm white 2700K 30K - Warm white 3000K 40K - Neutral white 4000K 50K - Cold white 5000K
Dimmable	Yes
Size	Ø50 x 500 mm Ø2" x 19 ¹¹ / ₁₆ "
Finish	BK - Black WH - White
IP	20

PRODUCT CODE

TT	-	TYPE	-	MODEL	-	POWER	-	FINISH	-	LED COLOR
TT	-	TRK	-	SUSP	-	10W	-	BK	-	27K
TT	-	TRK	-	SUSP	-	10W	-		-	

TITANIUM

TECHNOLOGY

TT-TRK-SUSP-CONE

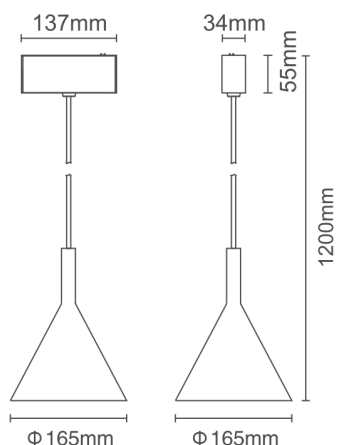

Diffuse

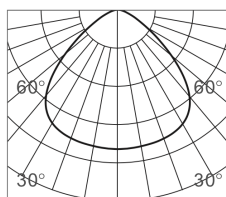

h(m)	E(lx)	Φ(m)
1	500	Φ1.20
2	125	Φ2.40
3	55.6	Φ3.60
4	31.2	Φ4.80
5	20	Φ6.00

PRODUCT CODE

TT - TYPE - MODEL - FORM - FINISH - LED COLOR

TT	-	TRK	-	SUSP	-	CONE	-	BK	-	27K
TT	-	TRK	-	SUSP	-	CONE	-		-	

Voltage 24vDC

Amperage 0,43A

Power LED 10,32W

Lumens 480 lm

CRI 90

Angle Diffuse

LED Color
27K - Warm white 2700K
30K - Warm white 3000K
40K - Neutral white 4000K
50K - Cold white 5000K

Dimmable Yes

Size 137 x 34 x 55 x 1200mm
 $5\frac{3}{8}$ " x $1\frac{5}{16}$ " x $2\frac{3}{16}$ " x $47\frac{1}{4}$ "

Finish **BK** - Black
WH - White

IP 20

TITANIUM

TECHNOLOGY

TT-TRK-TRACK-R

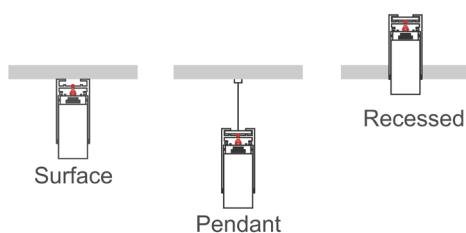
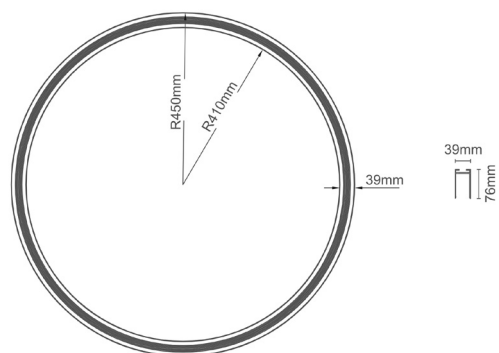

Voltage	24vDC
Size	900mm x 39mm x 76mm 35 ³ / ₈ " x 1 ¹ / ₂ " x 3"
Power	200w max.
Finish	BK - Black WH - White
IP	20

CODE PRODUIT

TT	-	TYPE	-	MODEL	-	UTILITY	-	FINISH
TT	-	TRK	-	TRACK	-	R	-	BK
TT	-	TRK	-	TRACK	-	R	-	

Accessories



TT-TRACK-SUSP

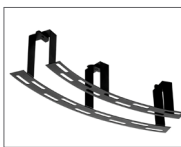

TT-TRK-R-PL

TITANIUM

TECHNOLOGY

TT-TRK-TRACK-R1/2

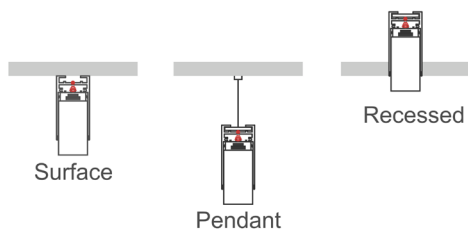
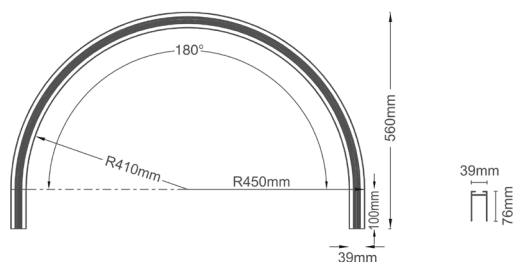

Voltage	24vDC
Size	906mm x 39mm x 76mm 35 ⁵ / ₈ " x 1 ¹ / ₂ " x 3"
Power	200w max.
Cut hole	40mm 1 ⁹ / ₁₆ "
Finish	BK - Black WH - White
IP	20

Accessories



TT-TRACK-SUSP

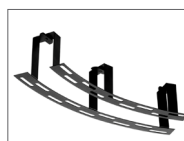

TT-TRK-R-PL

CODE PRODUIT

TT	-	TYPE	-	MODEL	-	UTILITY	-	FINISH
TT	-	TRK	-	TRACK	-	R1/2	-	BK
TT	-	TRK	-	TRACK	-	R1/2	-	

TITANIUM

TECHNOLOGY

TT-TRK-TRACK-R1/4

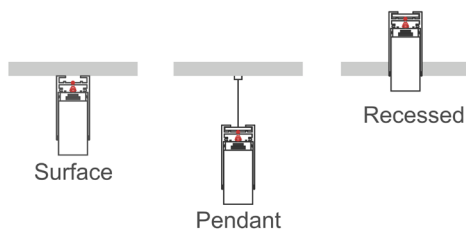
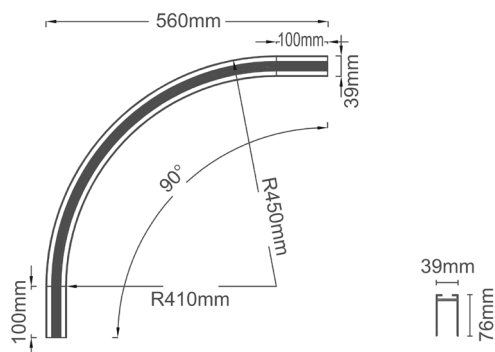

Voltage	24vDC
Size	560mm x 39mm x 76mm 22" x 1 1/2" x 3"
Power	200w max.
Finish	BK - Black WH - White
IP	20

Accessories



TT-TRACK-SUSP

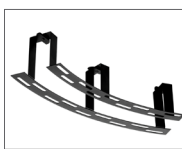

TT-TRK-R-PL

CODE PRODUIT

TT	-	TYPE	-	MODEL	-	UTILITY	-	FINISH
TT	-	TRK	-	TRACK	-	R1/4	-	BK
TT	-	TRK	-	TRACK	-	R1/4	-	

TITANIUM

TECHNOLOGY

TT-TRK-TRACK-R1/8

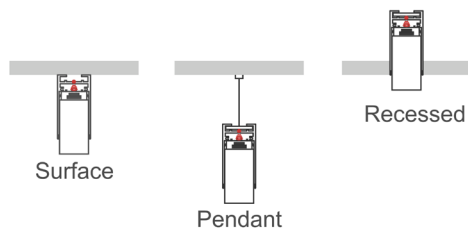
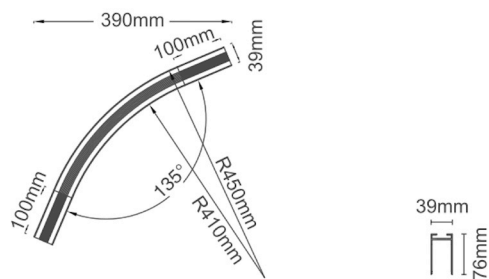

Voltage	24vDC
Size	390mm x 39mm x 76mm 15 ³ / ₈ " x 1 ¹ / ₂ " x 3"
Power	200w max.
Finish	BK - Black WH - White
IP	20

CODE PRODUIT

TT	-	TYPE	-	MODEL	-	UTILITY	-	FINISH
TT	-	TRK	-	TRACK	-	R1/8	-	BK
TT	-	TRK	-	TRACK	-	R1/8	-	

Accessories



TT-TRACK-SUSP

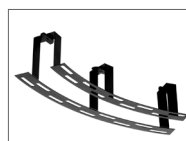

TT-TRK-R-PL

TITANIUM

TECHNOLOGY

TT-TRK-8W-1R

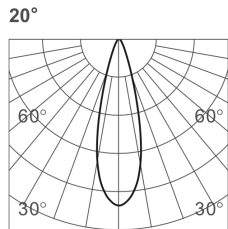
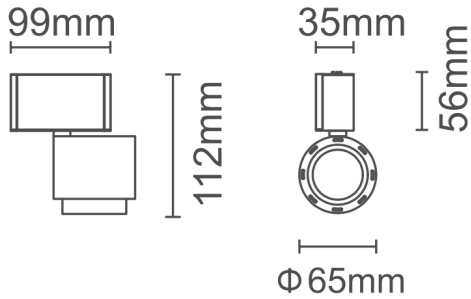

h(m)	E lx	Φ(m)
1	2675	Φ0.26
2	668	Φ0.53
3	297	Φ0.80
4	167	Φ1.06
5	107	Φ1.33

PRODUCT CODE

TT	- TYPE -	PWOER	PROJECTOR	- FINISH -	LED COLOR
TT	- TRK -	8W	- 1R -	BK	- 27K
TT	- TRK -	8W	- 1R -		

Voltage 24vDC

Amperage 0,36A

Power LED 8,64W

Lumens 405 lm

CRI 90

Angle 30°

LED Color
27K - Warm white 2700K
30K - Warm white 3000K
40K - Neutral white 4000K

Size 137 x 125 x 34 mm
 5³/₈" x 4⁷/₈" x 1³/₈"

Finish **BK** - Black
WH - White

IP 20

TITANIUM

TECHNOLOGY

TT-TRK-SUSP-10W-R

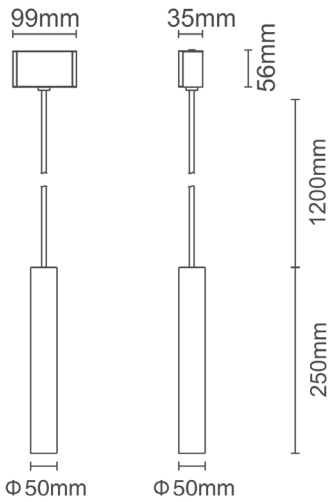

36°

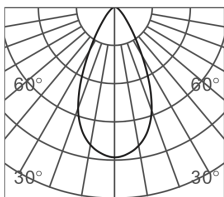

h(m)	E(lx)	Φ(m)
1	2154	Φ0.64
2	538	Φ1.28
3	239	Φ1.92
4	134	Φ2.56
5	86	Φ3.21

Voltage 24vDC

Amperage 0,46A

Power LED 11,04W

Lumens 780 lm

CRI 90

Angle 36°

LED Color
27K - Warm white 2700K
30K - Warm white 3000K
40K - Neutral white 4000K

Size 99 x 38 x 1450 mm
 3⁷/₈" x 1³/₈" x 57¹/₈"

Finish **BK** - Black
WH - White

IP 20

PRODUCT CODE

TT - TYPE - MODEL POWER - FORM - FINISH - LED COLOR

TT	-	TRK	-	SUSP	-	10W	-	R	-	BK	-	27K
TT	-	TRK	-	SUSP	-	10W	-	R	-		-	

TITANIUM

TECHNOLOGY

TT-TRK-15W-1R

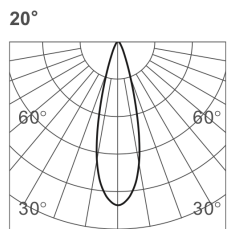
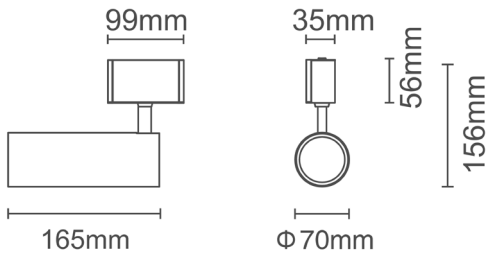

h(m)	E lx	Φ(m)
1	4847	Φ 0.30
2	1212	Φ 0.60
3	538	Φ 0.90
4	302	Φ 1.20
5	193	Φ 1.51

Voltage	24vDC
Amperage	0,68A
Power LED	16,32W
Lumens	905 lm
CRI	90
Angle	30°
LED Color	27K - Warm white 2700K 30K - Warm white 3000K 40K - Neutral white 4000K
Size	99 x 35 x 156 mm 3 ⁷ / ₈ " x 1 ³ / ₈ " x 6 ¹ / ₈ "
Finish	BK - Black WH - White
IP	20

PRODUCT CODE

TT	-	TYPE	-	POWER	-	PROJECTOR	-	FINISH	-	LED COLOR
TT	-	TRK	-	15W	-	1R	-	BK	-	27K
TT	-	TRK	-	15W	-	1R	-		-	

TITANIUM

TECHNOLOGY

TT-TRK-6X1R

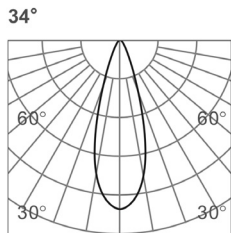
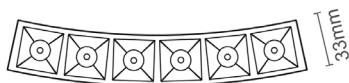
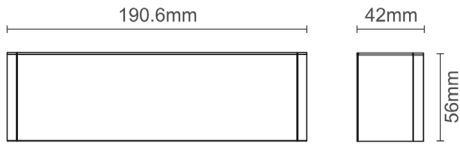

h(m)	E lx	Φ(m)
1	2800	Φ0.53
2	700	Φ1.07
3	311	Φ1.60
4	175	Φ2.14
5	112	Φ2.67

Voltage 24vDC

Amperage 0,36A

Power LED 8,64W

Lumens 790 lm

CRI 90

Angle 34°

LED Color
27K - Warm white 2700K
30K - Warm white 3000K
40K - Neutral white 4000K

Dimmable Yes

Size 190 mm x 42 mm x 56 mm
 7¹/₂" x 1⁵/₁₆" x 2³/₁₆"

Finish **BK** - Black
WH - White

IP 20

PRODUCT CODE

TT	-	TYPE	-	MODEL	-	FINISH	-	LED COLOR
TT	-	TRK	-	6X1R	-	BK	-	27K
TT	-	TRK	-	6X1R	-		-	

TITANIUM

TECHNOLOGY

TT-TRK-163R

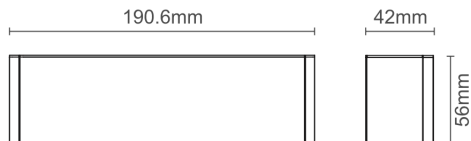

Diffuse

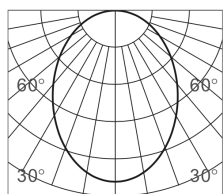

h(m)	E(lx)	Φ(m)
1	119	Φ2.56
2	29	Φ5.12
3	13	Φ7.68
4	7	Φ10.24
5	4	Φ12.81

Voltage 24vDC

Amperage 0,36A

Power LED 8,64W

Lumens 500 lm

CRI 90

Angle Diffuse

LED Color
27K - Warm white 2700K
30K - Warm white 3000K
40K - Neutral white 4000K

Dimmable Yes

Size 190 mm x 42 mm x 56 mm
 $7\frac{1}{2}'' \times 1\frac{5}{16}'' \times 2\frac{3}{16}''$

Finish **BK** - Black
WH - White

IP 20

PRODUCT CODE

TT	-	TYPE	-	MODEL	-	FINISH	-	LED COLOR
TT	-	TRK	-	163R	-	BK	-	27K
TT	-	TRK	-	163R	-		-	

TITANIUM

TECHNOLOGY

TT-TRK-5W-1R

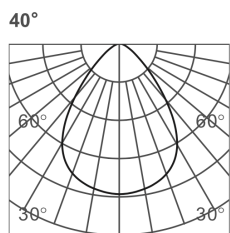
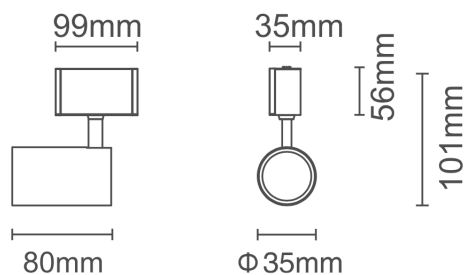

h(m)	E(lx)	Φ(m)
2	278	Φ0.96
3	124	Φ1.44
3.5	91	Φ1.68
4	69	Φ1.92
5	44	Φ2.40

Voltage 24vDC

Amperage 0,24A

Power LED 5,76W

Lumens 440 lm

CRI 90

LED Color
27K - Warm white 2700K
30K - Warm white 3000K
40K - Neutral white 4000K

Dimmable Yes

Size 99 mm x 35 mm x 101
 3⁷/₈" x 1³/₈" x 4"

Finish **BK** - Black
WH - White

IP 20

PRODUCT CODE

TT	- TYPE -	POWER	- PROJECTOR -	FINISH	- LED COLOR
TT	- TRK -	5W	- 1R -	BK	27K
TT	- TRK -	5W	- 1R -		

TITANIUM

TECHNOLOGY

TT-TRK-10W-1R

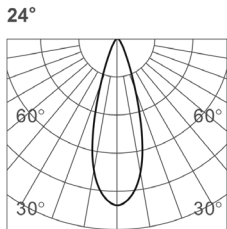
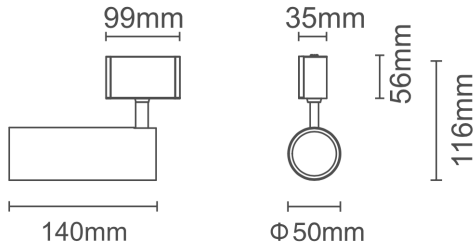

h(m)	E(lx)	Φ(m)
1	3857	Φ0.40
2	964	Φ0.81
3	428	Φ1.22
4	241	Φ1.62
5	154	Φ2.03

PRODUCT CODE

TT	TYPE	POWER	PROJECTOR	FINISH	LED COLOR
TT	TRK	10W	1R	BK	27K
TT	TRK	10W	1R		

Voltage 24vDC

Amperage 0,44A

Power LED 10,56W

Lumens 780 lm

CRI 90

Angle 24°

LED Color
27K - Warm white 2700K
30K - Warm white 3000K
40K - Neutral white 4000K

Dimmable Yes

Size 99 mm x 35 mm x 116
 3⁷/₈" x 1³/₈" x 3⁹/₁₆"

Finish
BK - Black
WH - White

IP 20

TITANIUM

TECHNOLOGY

TT-TRK-BALL-R

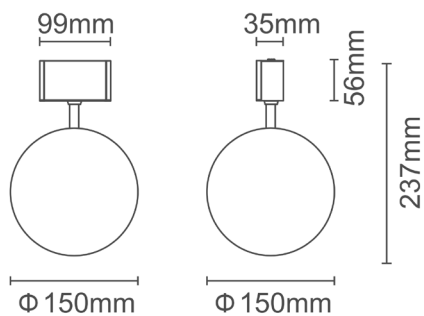

Diffuse

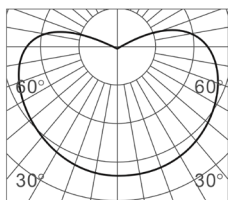

h(m)	E(lx)	Φ(m)
1	24	Φ2
2	6	Φ4
3	2	Φ6
4	1	Φ8
5	0.9	Φ10

PRODUCT CODE

TT - TYPE - FORM - FINISH - LED COLOR

TT - TRK - BALL-R - BK - 27K

TT - TRK - BALL-R - - -

Voltage 24vDC

Amperage 0,30A

Power LED 7,2W

Lumens 290 lm

CRI 90

Angle 220°

LED Color
27K - Warm white 2700K
30K - Warm white 3000K
40K - Neutral white 4000K

Size 99 x 35 x 237 mm
 3⁷/₈" x 1³/₈" x 9³/₈"

Finish **BK** - Black
WH - White

IP 20

TITANIUM

TECHNOLOGY

TT-TRK-L

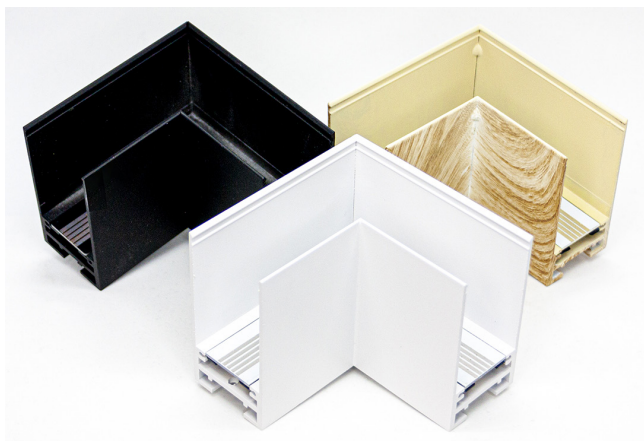

- Corner

PRODUCT CODE

TT	-	TYPE	-	MODEL	-	FINISH
TT	-	TRK	-	L	-	BK
TT	-	TRK	-	L	-	

Dimension	39 x 76 x 90 mm 1 9/16" x 3" x 3 9/16"
Finish	BK - Black WH - White WOOD - Wood

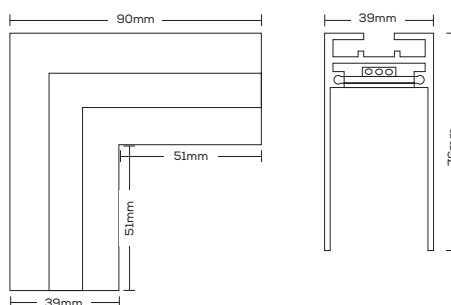

TT-TRK-Lo



- Outside corner union

PRODUCT CODE

TT	-	TYPE	-	MODEL	-	FINISH
TT	-	TRK	-	Lo	-	BK
TT	-	TRK	-	Lo	-	

Dimension	39 x 76 x 123 mm 1 9/16" x 3" x 4 7/8"
Finish	BK - Black WH - White

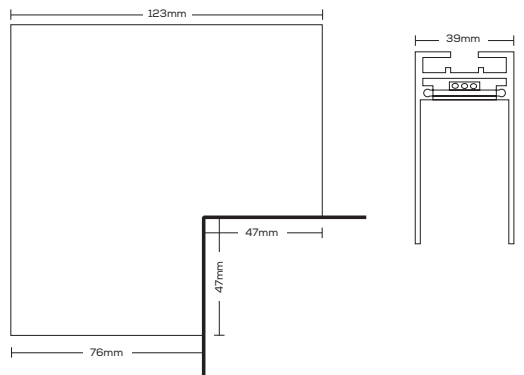

TITANIUM

TECHNOLOGY

TT-TRK-Li

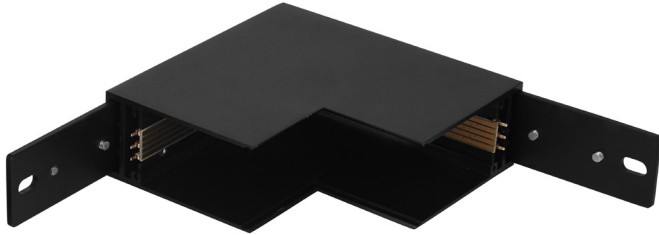

- Union interior corner

PRODUCT CODE

TT	-	TYPE	-	MODEL	-	FINISH
TT	-	TRK	-	Li	-	BK
TT	-	TRK	-	Li	-	

Dimension	39 x 76 x 123 mm
	1 9/16" x 3" x 4 7/8"
Finish	BK - Black
	WH - White

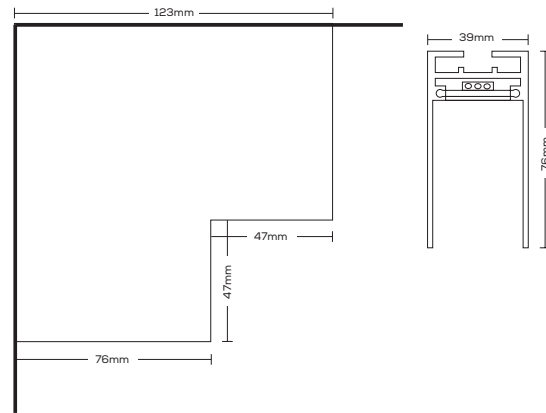

TT-TRK-T



- T Corner

PRODUCT CODE

TT	-	TYPE	-	MODEL	-	FINISH
TT	-	TRK	-	T	-	BK
TT	-	TRK	-	T	-	

Dimension	39 x 76 x 141 mm
	1 9/16" x 3" x 5 9/16"
Finish	BK - Black
	WH - White

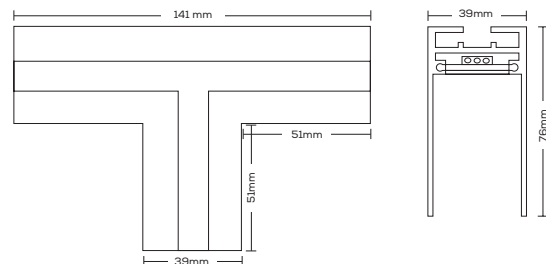

TITANIUM

TECHNOLOGY

TT-TRK-X



- X Corner

PRODUCT CODE

TT	-	TYPE	-	MODEL	-	FINISH
TT	-	TRK	-	X	-	BK
TT	-	TRK	-	X	-	

Dimension	39 x 76 x 141 mm
	1 9/16" x 3" x 5 9/16"
Finish	BK - Black
	WH - White

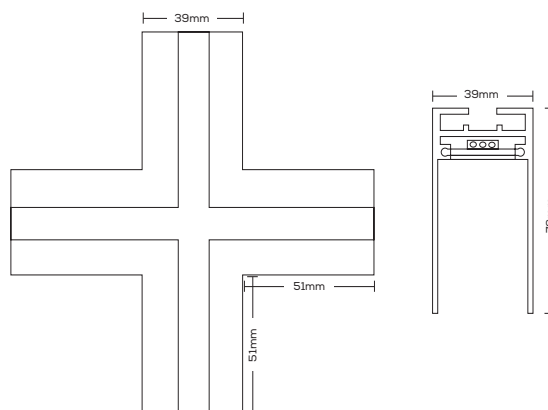

TT-TRK-V



- V Corner

PRODUCT CODE

TT	-	TYPE	-	MODEL	-	FINISH
TT	-	TRK	-	V	-	BK
TT	-	TRK	-	V	-	

Dimension	39 x 76 x 110 mm
	1 9/16" x 3" x 5 9/16"
Finish	BK - Black
	WH - White

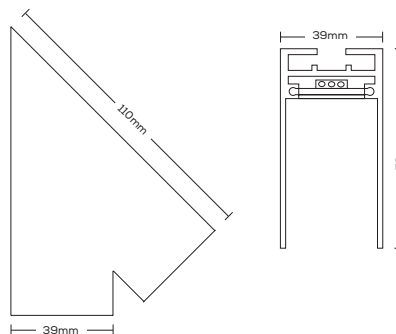

TITANIUM

TECHNOLOGY

TT-TRK-L-PL

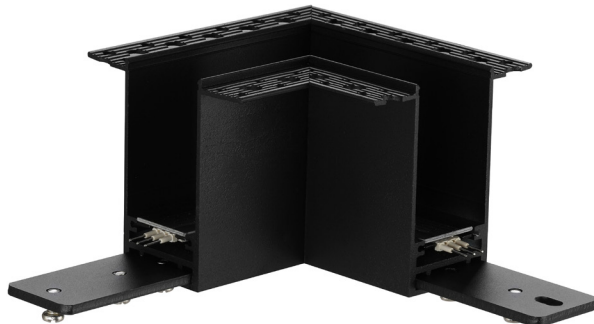

- Corner

PRODUCT CODE

TT	-	TYPE	-	MODEL	-	FINISH
TT	-	TRK	-	L-PL	-	BK
TT	-	TRK	-	L-PL	-	

Dimension	39 x 76 x 90 mm
	1 9/16" x 3" x 3 9/16"
Finish	BK - Black
	WH - White

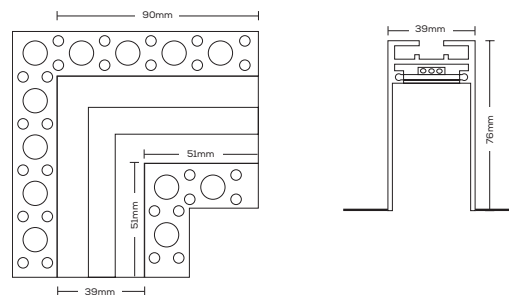

TT-TRK-Lo-PL

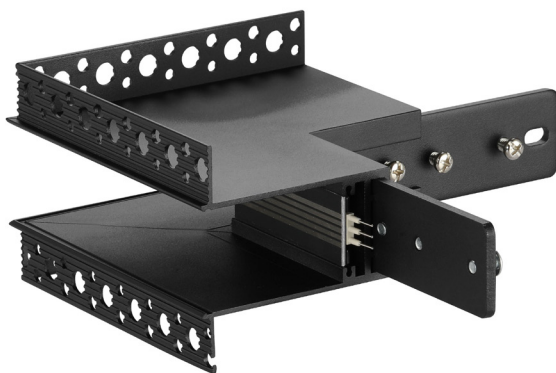

- Outside corner union

PRODUCT CODE

TT	-	TYPE	-	MODEL	-	FINISH
TT	-	TRK	-	Lo-PL	-	BK
TT	-	TRK	-	Lo-PL	-	

Dimension	39 x 76 x 90 mm
	1 9/16" x 3" x 3 9/16"
Finish	BK - Black
	WH - White

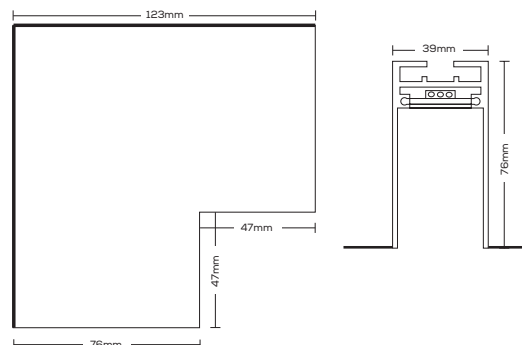

TITANIUM

TECHNOLOGY

TT-TRK-Li-PL



- Union interior corner

PRODUCT CODE

TT	-	TYPE	-	MODEL	-	FINISH
TT	-	TRK	-	Li-PL	-	BK
TT	-	TRK	-	Li-PL	-	

Dimension	39 x 76 x 90 mm
	1 ⁹ / ₁₆ " x 3" x 3 ⁹ / ₁₆ "
Finish	BK - Black
	WH - White

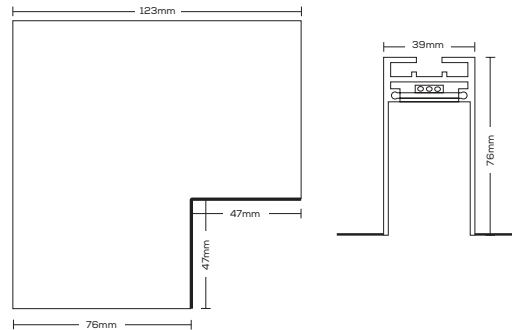

TT-TRK-T-PL



- T Corner

PRODUCT CODE

TT	-	TYPE	-	MODEL	-	FINISH
TT	-	TRK	-	T-PL	-	BK
TT	-	TRK	-	T-PL	-	

Dimension	39 x 76 x 141 mm
	1 ⁹ / ₁₆ " x 3" x 5 ⁹ / ₁₆ "
Finish	BK - Black
	WH - White

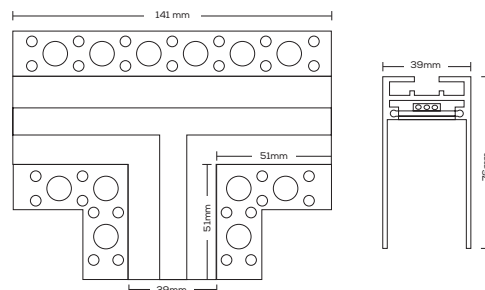

TITANIUM

TECHNOLOGY

TT-TRK-END

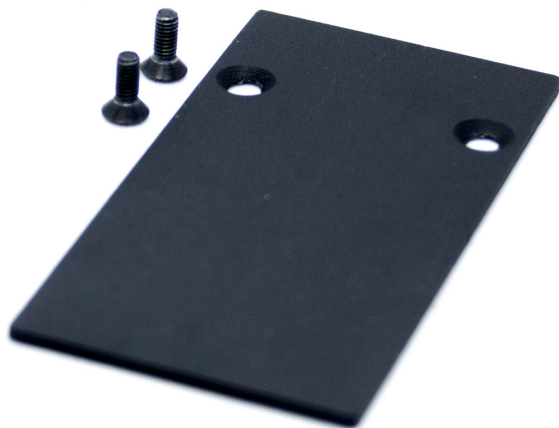

- End cap.

PRODUCT CODE

TT	-	TYPE	-	MODEL	-	FINISH
TT	-	TRK	-	END	-	BK
TT	-	TRK	-	END	-	

Dimension	39 x 76 x 2.5mm 1 9/16" x 3" x 1/8"
Finish	BK - Black WH - White WOOD - Wood

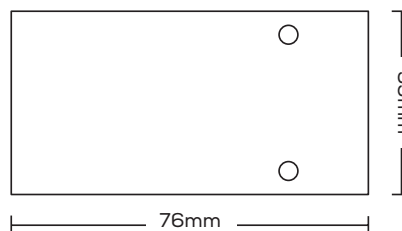

TT-TRK-CLIP



- Clip

PRODUCT CODE

TT	-	TYPE	-	MODEL	-	FINISH
TT	-	TRK	-	CLIP	-	BK
TT	-	TRK	-	CLIP	-	

Dimension	43 x 67 x 39 mm 1 11/16" x 2 5/8" x 1 9/16"
Finish	BK - Black WH - White

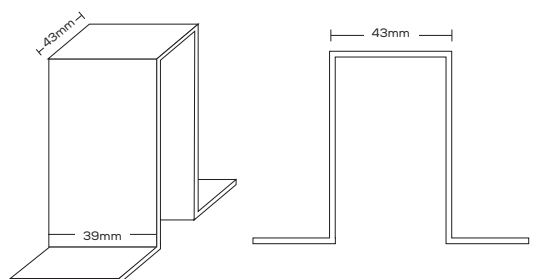

TITANIUM

TECHNOLOGY

TT-TRK-COVER



Dimension	36 x 1000 mm x 2.5mm 1 7/16" x 39 3/8" x 1/8"
Finish	BK - Black WH - White WOOD - Wood

- Blank cover

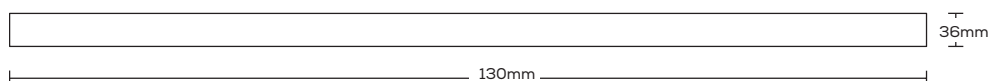

PRODUCT CODE

TT	-	TYPE	-	MODEL	-	FINISH
TT	-	TRK	-	COVER	-	BK
TT	-	TRK	-	COVER	-	

TT-TRK-EXT



Dimension	130 x 33 x 4 mm 5 1/8" x 1 5/16" x 3/16"
Finish	BK - Black WH - White WOOD - Wood

- Junction bar

PRODUCT CODE

TT	-	TYPE	-	MODEL	-	FINISH
TT	-	TRK	-	EXT	-	BK
TT	-	TRK	-	EXT	-	

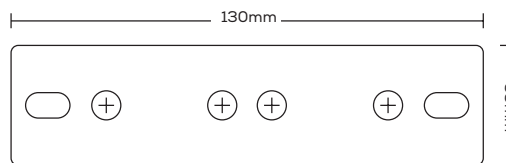

TITANIUM

TECHNOLOGY

TT-TRK-O

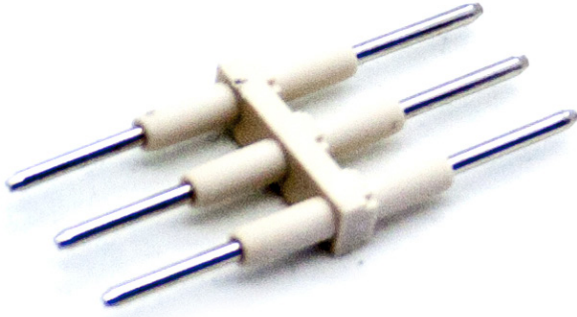

- Pin for electrical conductor

Dimension	26 x 11 x 3 mm
	1" x 7/16" x 1/8"

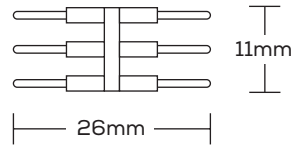

PRODUCT CODE

TT	-	TYPE	-	MODEL
TT	-	TRK	-	O
TT	-	TRK	-	O

TT-TRK-I



- Electrical conductor

Dimension	65 x 31 x 3 mm
	2 9/16" x 1 1/4" x 1/8"

Finish	BK - Black
--------	-------------------

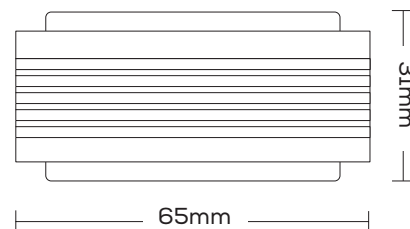

PRODUCT CODE

TT	-	TYPE	-	MODEL	-	FINISH
TT	-	TRK	-	I	-	BK
TT	-	TRK	-	I	-	

TITANIUM

TECHNOLOGY

TT-TRK-SUSP-A

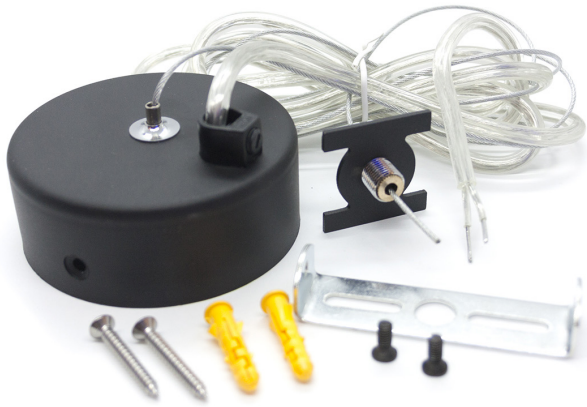

- Suspension kit with power cord.

PRODUCT CODE

TT	-	TYPE	-	MODEL	-	FINISH
TT	-	TRK	-	SUSP-A	-	BK
TT	-	TRK	-	SUSP-A	-	

Dimension	Ø80 x 30 mm
	Ø3 3/16" x 1 3/16"
Finish	BK - Black
	WH - White

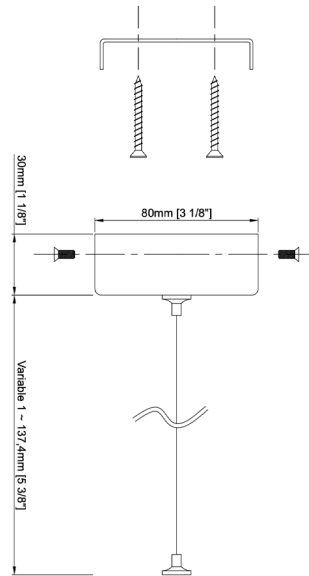

TT-TRK-SUSP-B



- Suspension kit

PRODUCT CODE

TT	-	TYPE	-	MODEL	-	FINISH
TT	-	TRK	-	SUSP-B	-	BK
TT	-	TRK	-	SUSP-B	-	

Dimension	Ø80 x 30 mm
	Ø3 3/16" x 1 3/16"
Finish	BK - Black
	WH - White

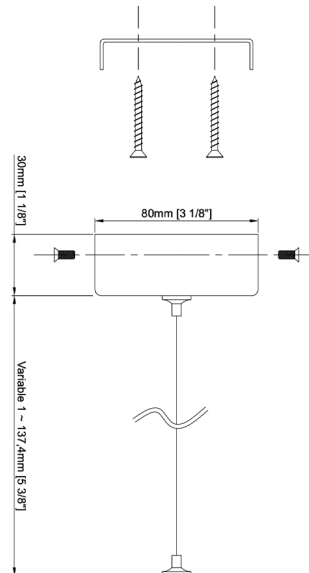

TITANIUM

TECHNOLOGY

TT-TRK-SUSP-C



- Suspension kit with power cord.

PRODUCT CODE

TT	-	TYPE	-	MODEL	-	FINISH
TT	-	TRK	-	SUSP-C	-	BK
TT	-	TRK	-	SUSP-C	-	

Dimension	Ø110 x 25 mm Ø4 5/8" x 1"
Finish	BK - Black WH - White

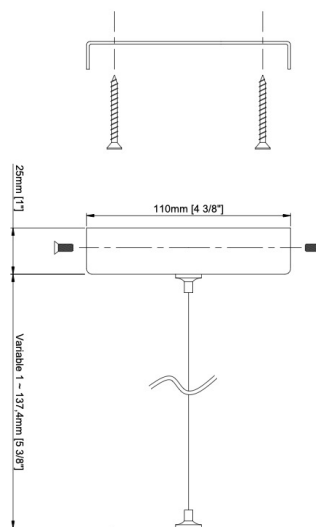

TT-TRK-SUSP-D

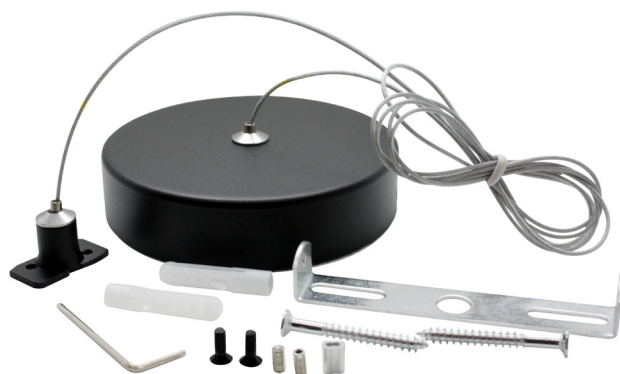

- Suspension kit

PRODUCT CODE

TT	-	TYPE	-	MODEL	-	FINISH
TT	-	TRK	-	SUSP-D	-	BK
TT	-	TRK	-	SUSP-D	-	

Dimension	Ø100 x 25 mm Ø4 5/8" x 1"
Finish	BK - Black WH - White

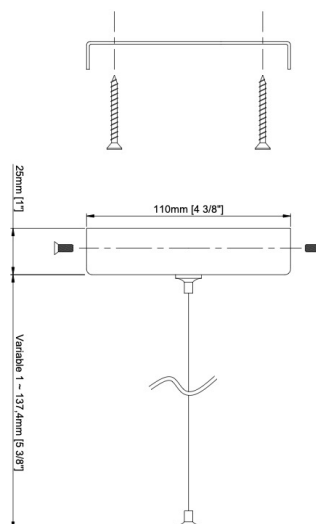

TITANIUM

TECHNOLOGY

TT-TRK-CONNECT-PL



- Power junction.

PRODUCT CODE

TT	-	TYPE	-	MODEL	-	FINISH
TT	-	TRK	-	CONNECT-PL	-	BK
TT	-	TRK	-	CONNECT-PL	-	

Dimension	39 x 76 x 47 mm 1 9/16" x 3" x 1 7/8"
Finish	BK - Black WH - White

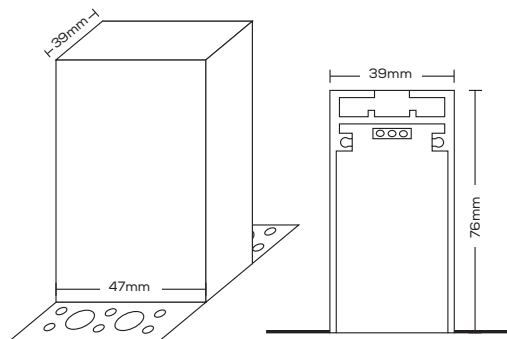

TT-TRK-CONNECT



- Power junction.

PRODUCT CODE

TT	-	TYPE	-	MODEL	-	FINISH
TT	-	TRK	-	CONNECT	-	BK
TT	-	TRK	-	CONNECT	-	

Dimension	39 x 76 x 47 mm 1 9/16" x 3" x 1 7/8"
Finish	BK - Black WH - White WOOD - Wood

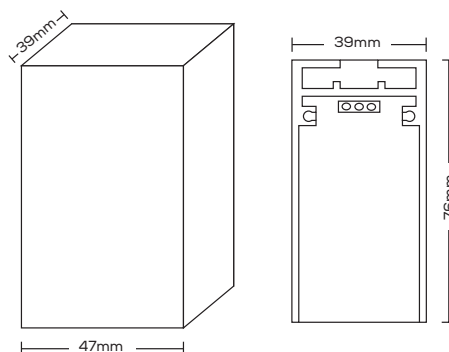

SUSPENDED CONFIGURATIONS

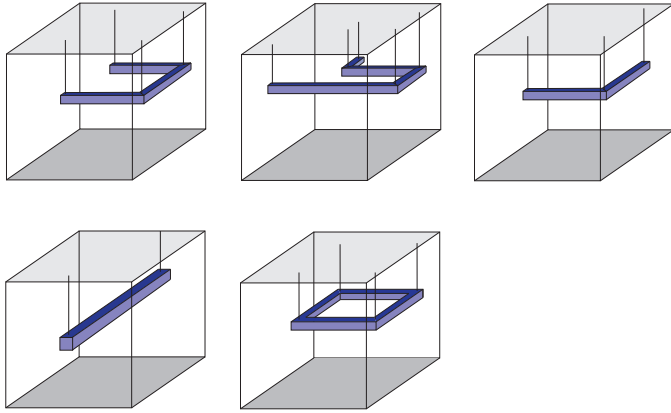

WALL ONLY CONFIGURATIONS

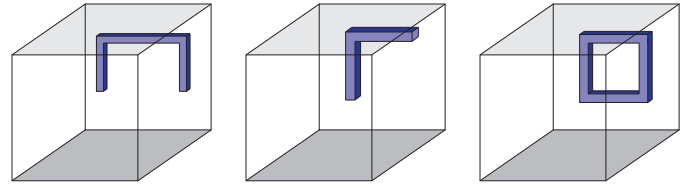

CEILING ONLY CONFIGURATIONS

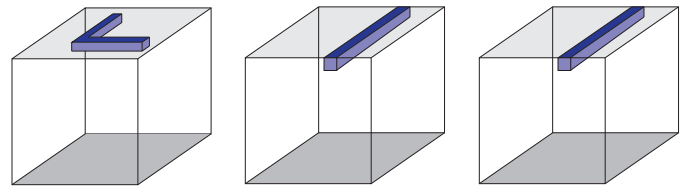

WALL TO CEILING CONFIGURATIONS

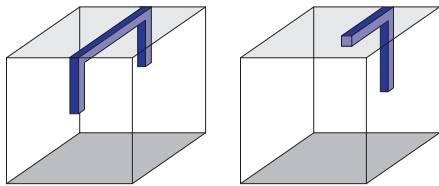

WALL TO WALL CONFIGURATIONS

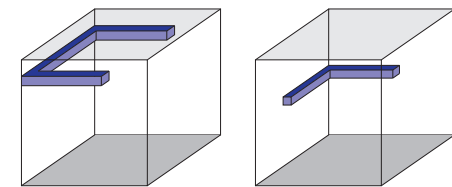

SEGMENT STANDARD LENGTHS

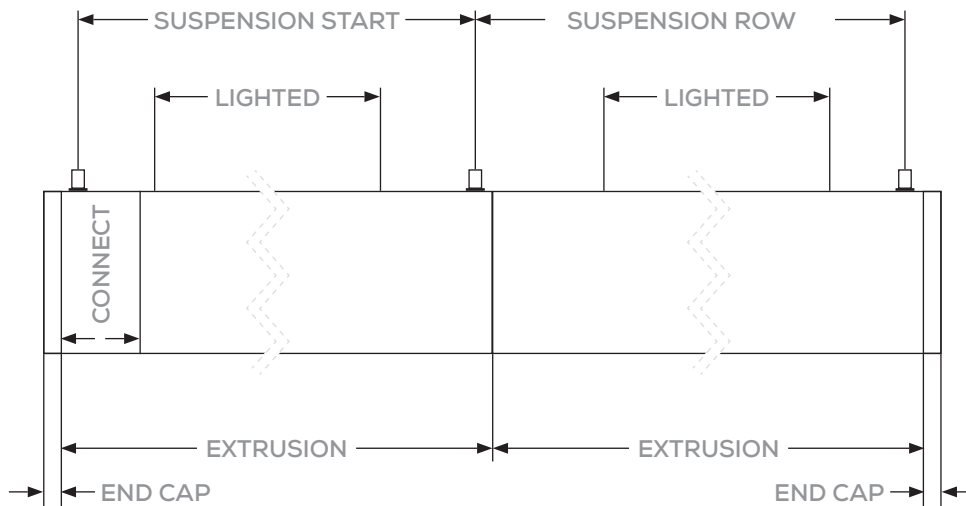

MAXIMUM MODULE QUANTITY PER DRIVER

Maximum quantity of fixtures per driver are calculated by dividing the maximum DC load (200w) by the DC power consumption per module. For example, a maximum of TT-TRK-640 can be powered by a single power feed: $200w \div 26w = 7$ units. A variety of different fixtures are available and combining several fixtures is possible and recommended.

TT-DR-CV-200-BOX



- Transformers dimmable to the primary 120vAC.
- 160 watts maximum load.
- Minimum load of 1 watts.
- Triac dimmable from 5% to 100%

Voltage in	120vAC	
Voltage out	12vDC	24vDC
Amperage in	3,2A	3,2A
Amperage out	16,6A	8,3A
Power	200w	
Minimum Load	1w	
Size	405mm x 85mm x 63mm 16" x 3 3/8" x 2 1/2"	
Dimmable	Yes - Forward phase, Magnetic low voltage 5% ~100% Triac	
IP	66	

TT-DR-CV-384-24V-BOX-5IN1



- Transformers dimmable to the primary 120vAC.
- 4 x out 96w.
- 5 in 1
- Class 2

Voltage in	120vAC	
Voltage out	24vDC Class 2	
Amperage in	4,8A	
Amperage out	4 x 4A	
Power	4 x 96w	
Size	405mm x 85mm x 63mm 16" x 3 3/8" x 2 1/2"	
Dimmable	Yes 5% ~100% Triac 0-10V Potentiometer 10V PWM	
IP	66	
Dimming	Triac 0-10V Potentiometer 10V pwm Phase	

TITANIUM

TECHNOLOGY

Surface mount kit

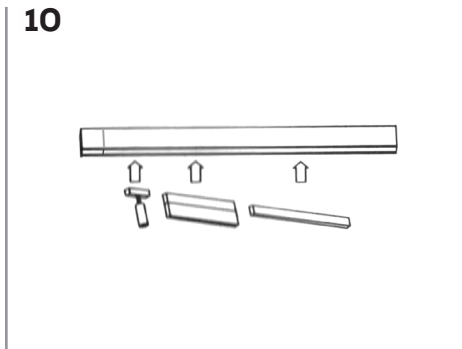
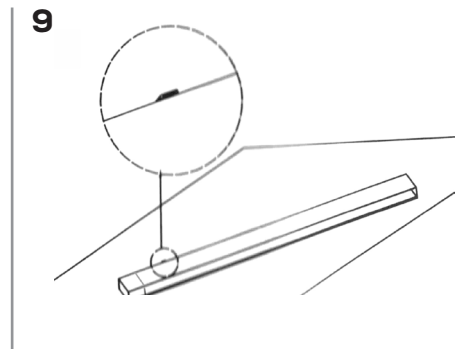
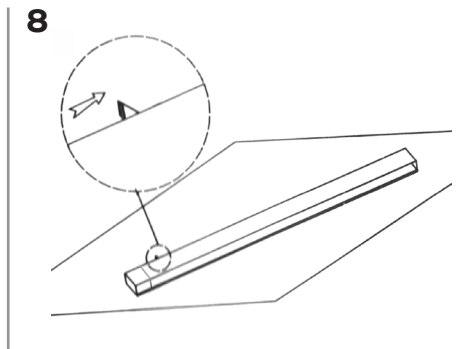
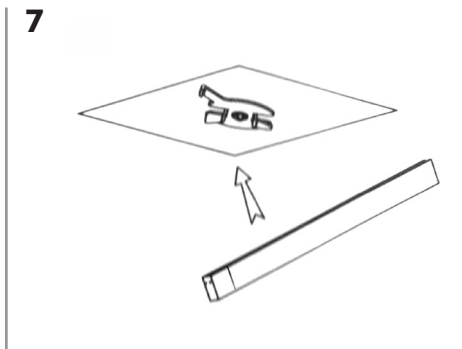
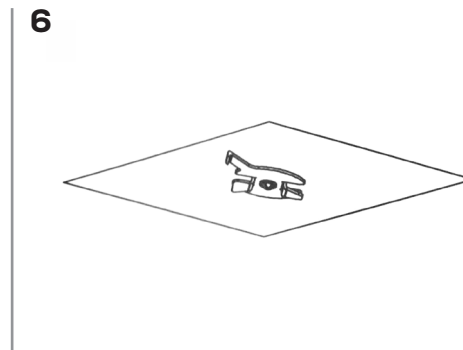
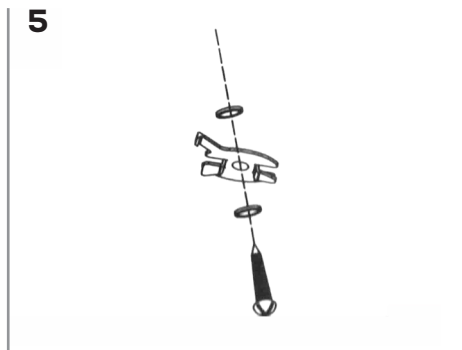
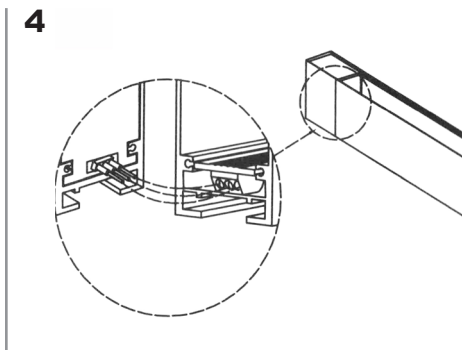
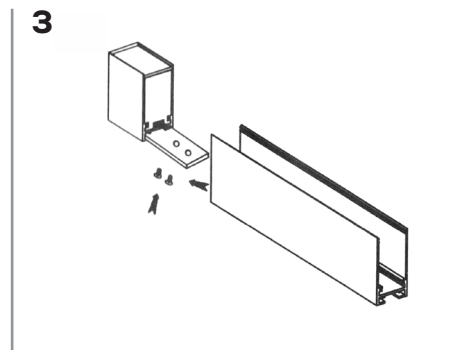
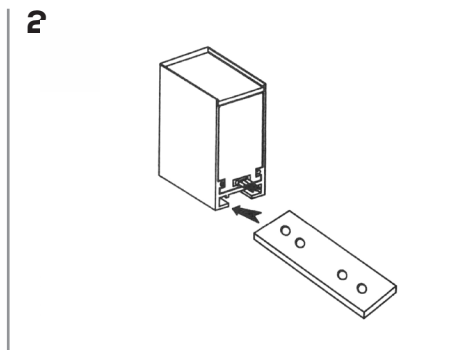
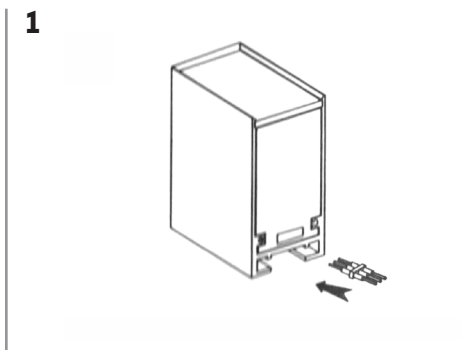

Surface mounted

Caution : This system is a LOW Voltage DC24V product

1

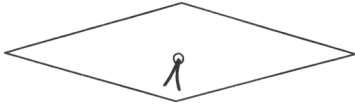

2

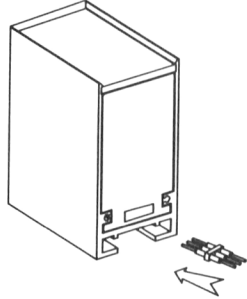

3

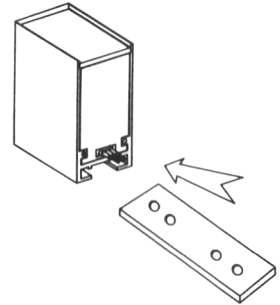

4

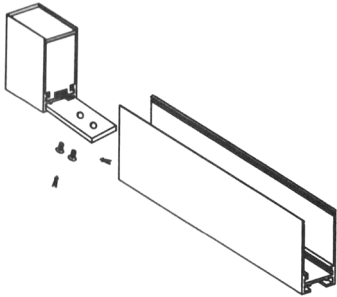

5

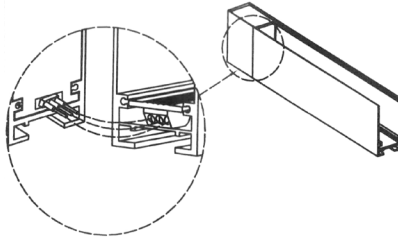

6

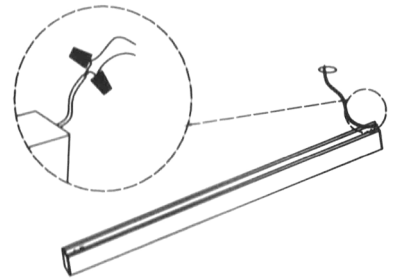

7

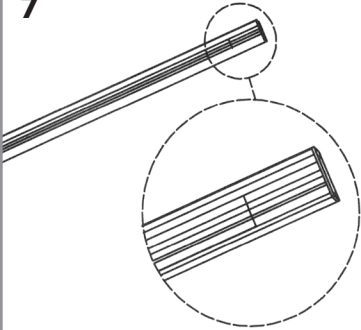

8

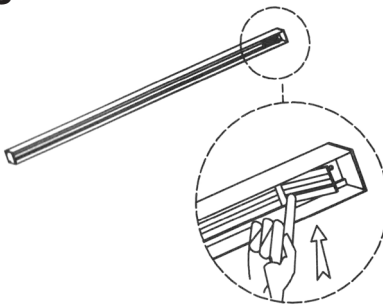

9

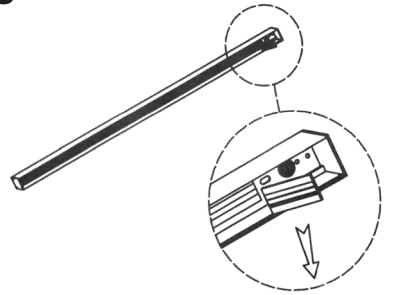

10

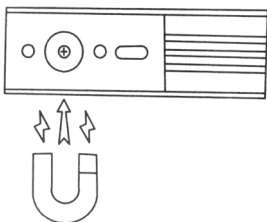

11

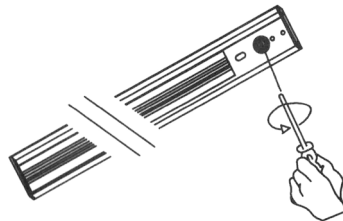

12

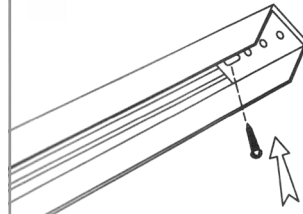

Surface mounted (continued)

13

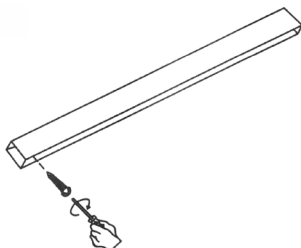

14

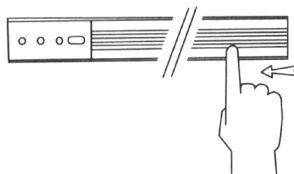

15

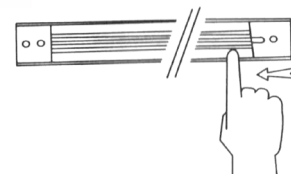

16

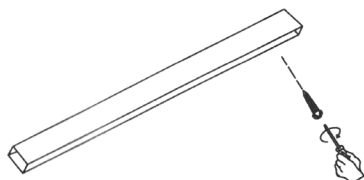

17

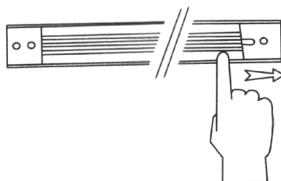

18

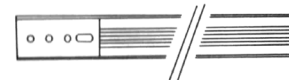

19

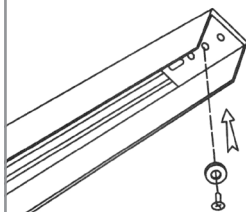

20

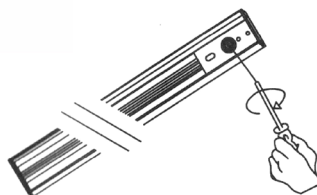

21

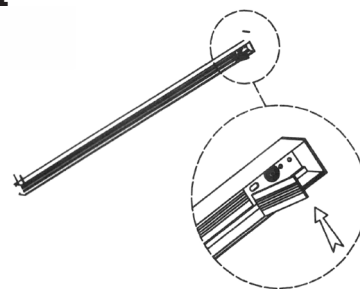

22

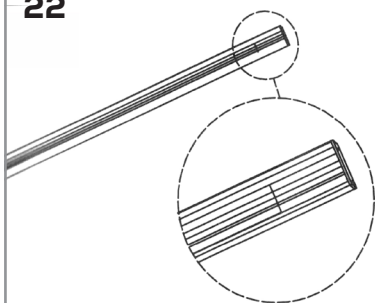

23

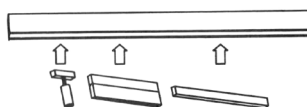

24



Recessed mounted

1

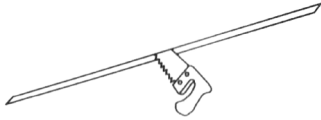

2

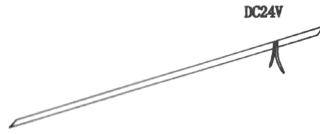

3

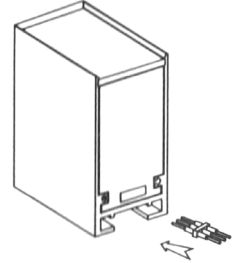

4

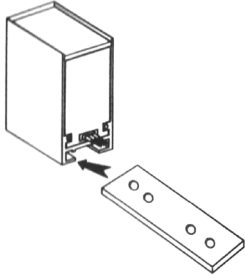

5

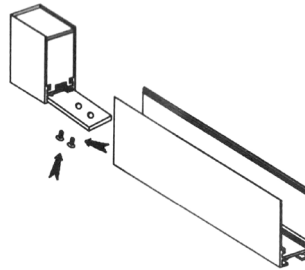

6

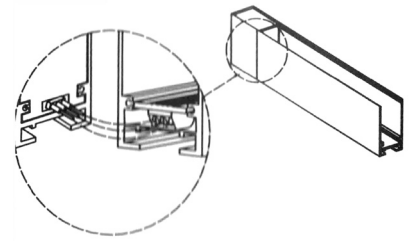

7

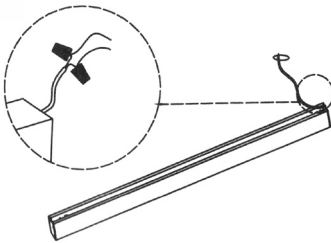

8

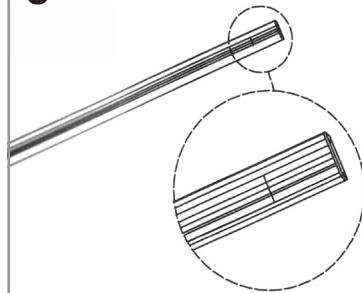

9

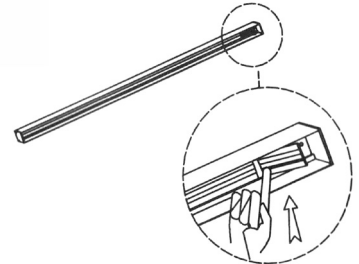

10

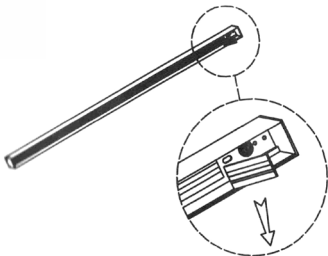

11

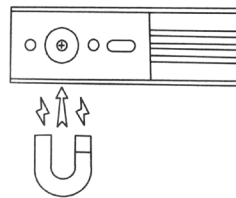

12

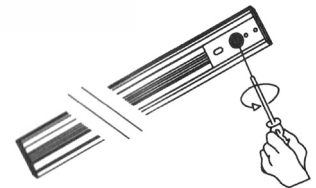

TITANIUM

TECHNOLOGY

Recessed mounted (continued)

13

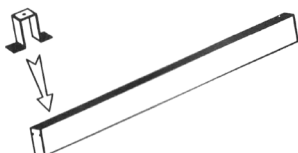

14

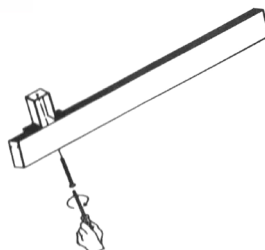

15

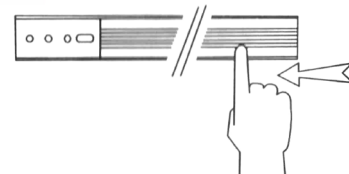

16

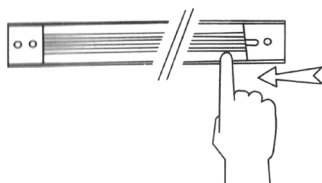

17

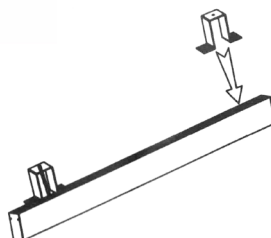

18

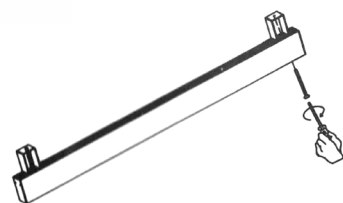

19

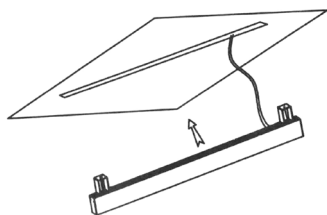

20

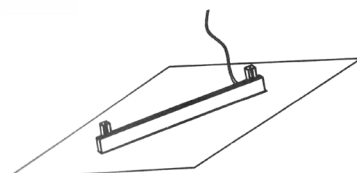

21

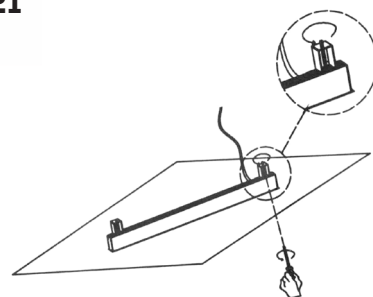

22

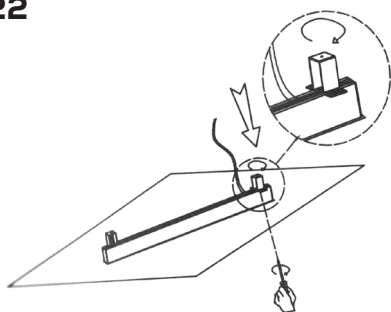

23

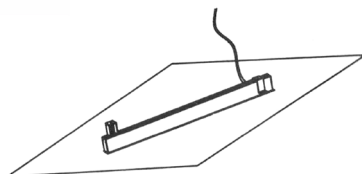

24

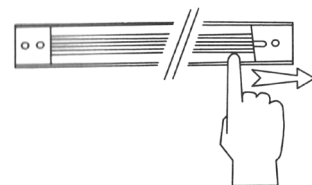

Recessed mounted (continued)

25

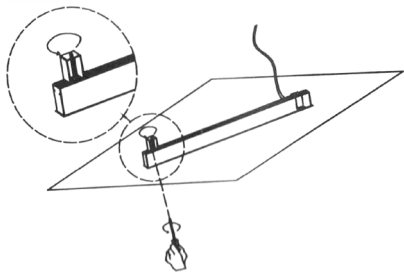

26

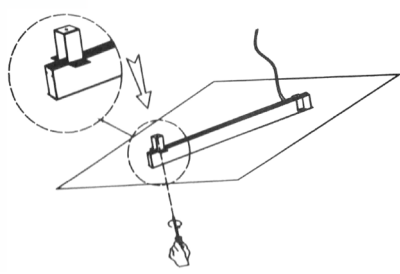

27

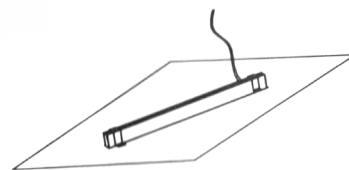

28



29



30

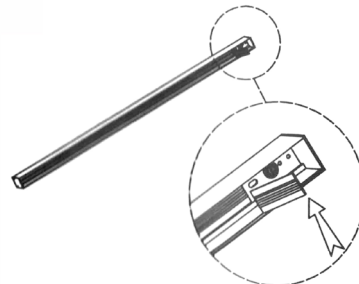

31

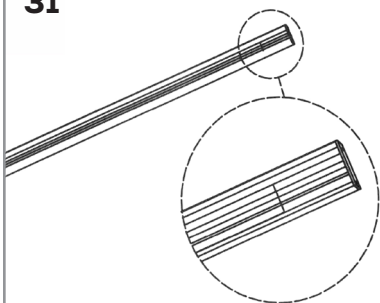

32



33

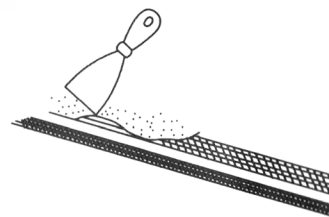

34

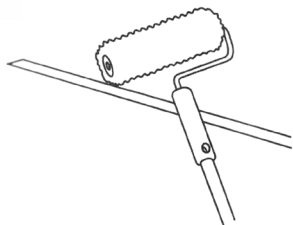

35

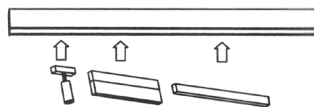

36

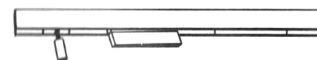

TITANIUM

TECHNOLOGY

Pendant mounted

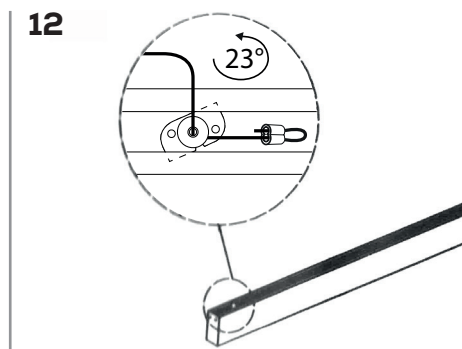
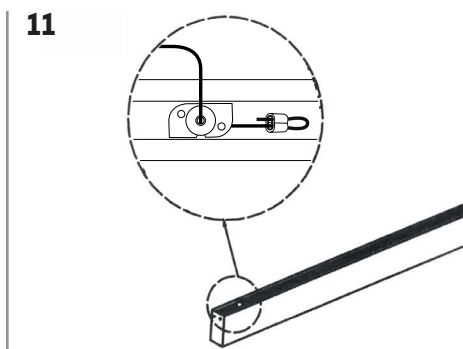
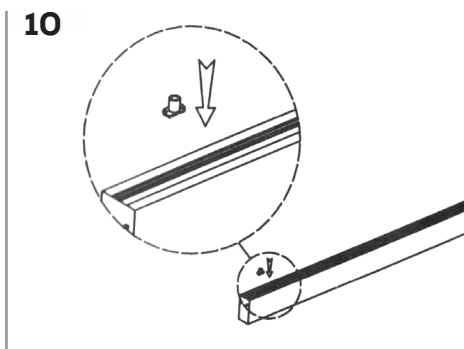
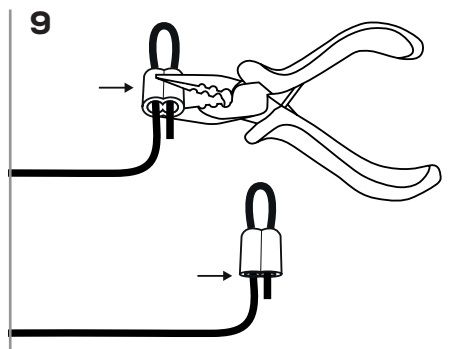
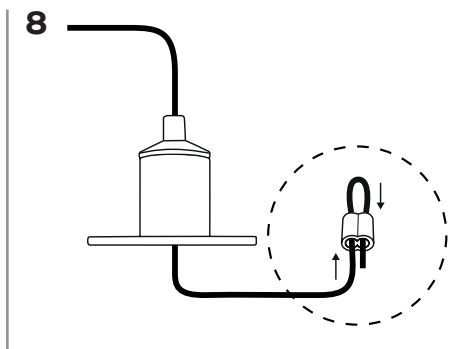
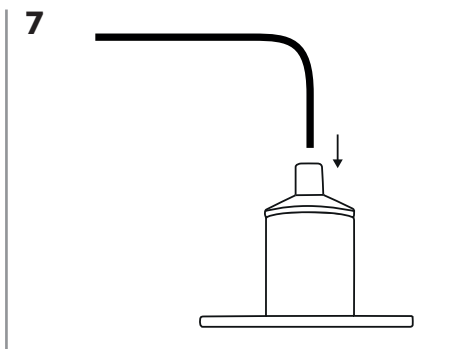
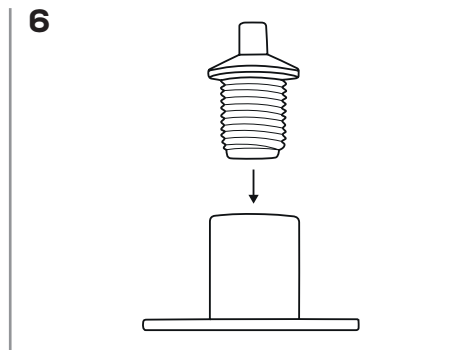
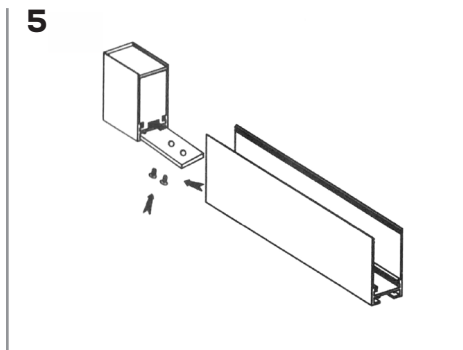
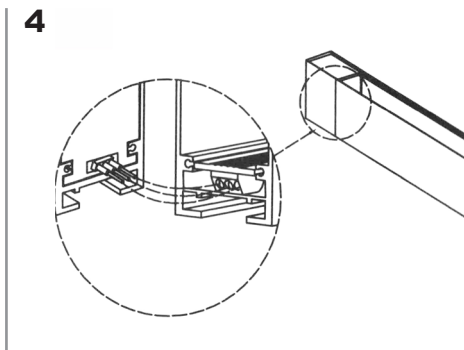
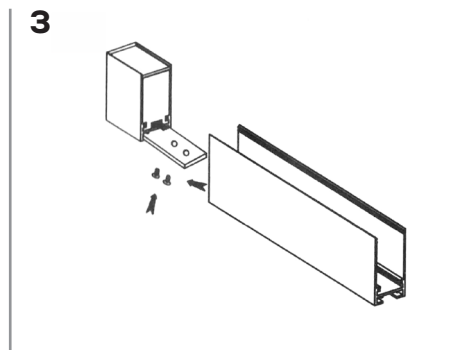
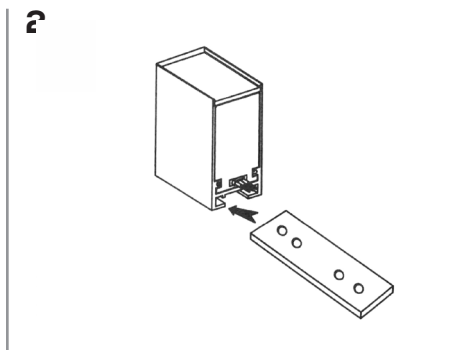
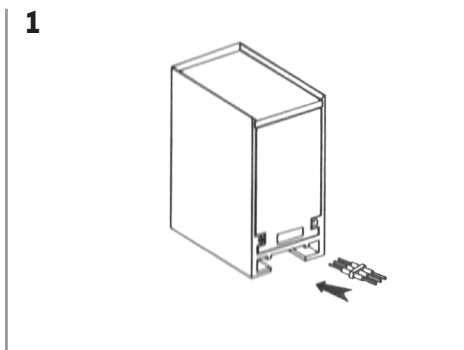

Pendant mounted (continued)

13

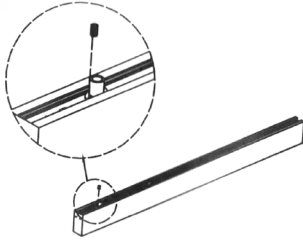

14

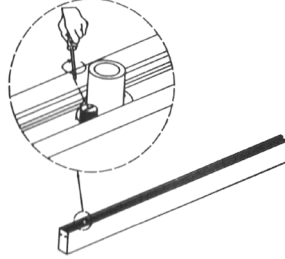

15

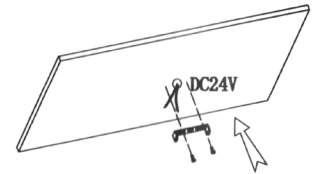

16

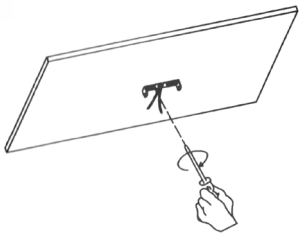

17

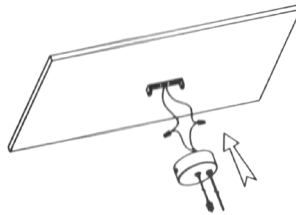

18

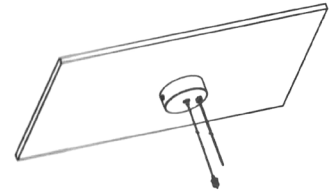

19

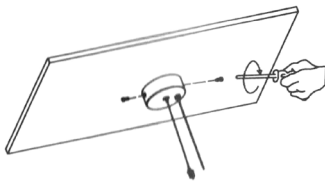

20

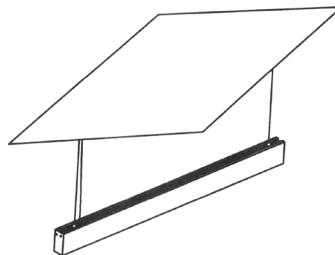

Recessed mounted with trim

1

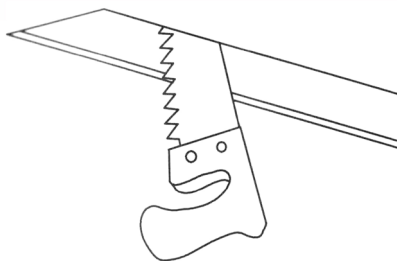

2

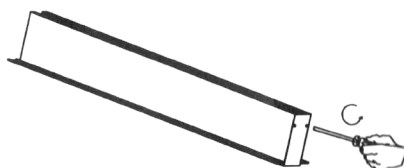

3

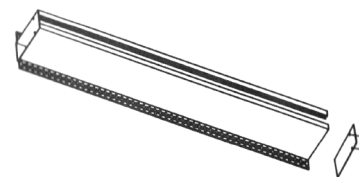

4

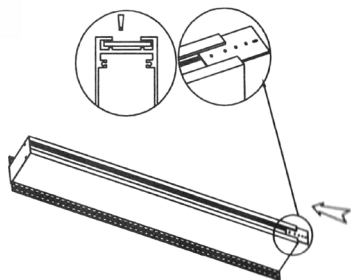

5

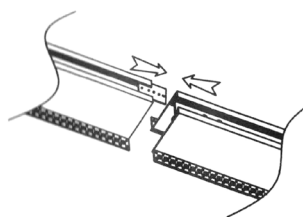

6

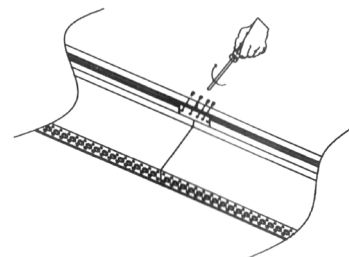

7

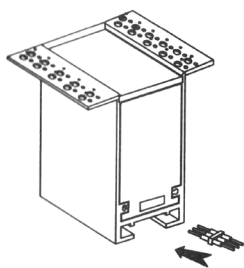

8

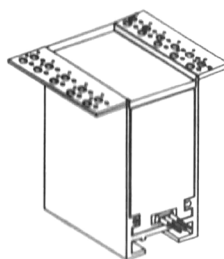

9

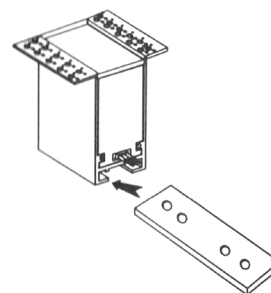

10

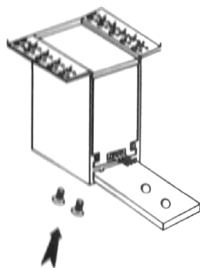

11

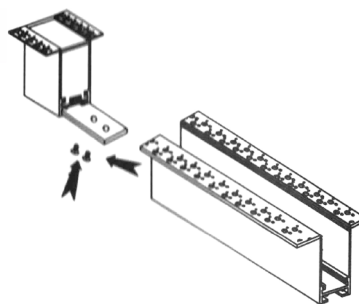

12

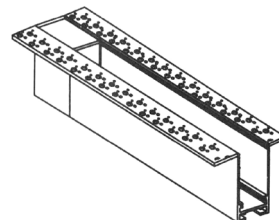

Recessed mounted with trim (continued)

13

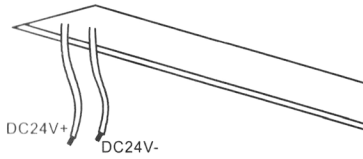

14

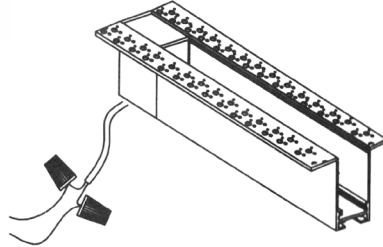

15

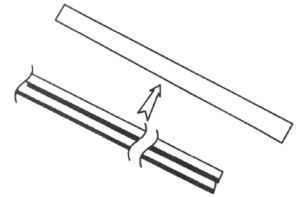

16

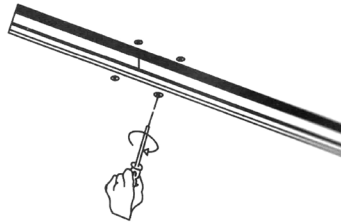

17



18

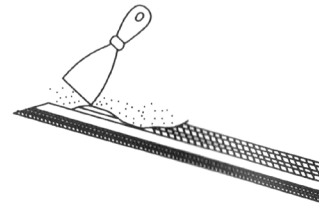

19

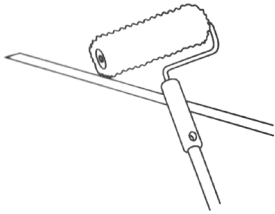

20

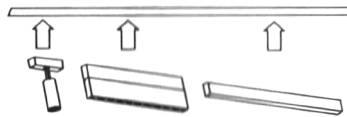

21



Input terminal connection

1

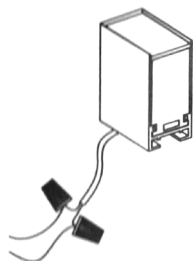

2

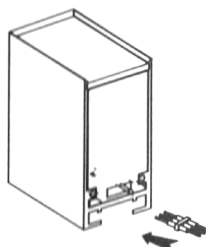

3

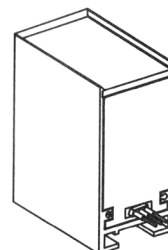

4

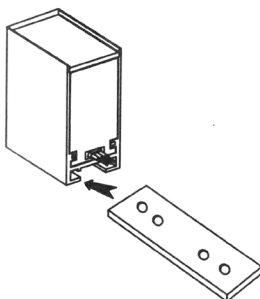

5

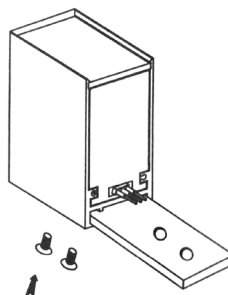

6

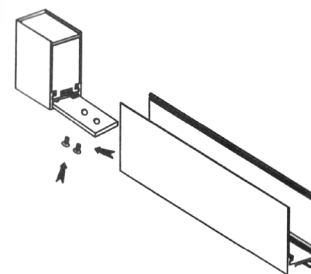

7

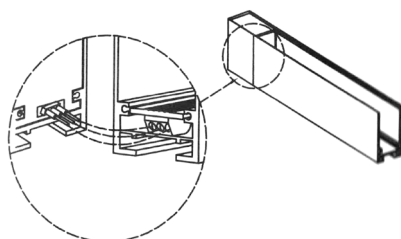

8

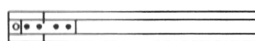

Track connection

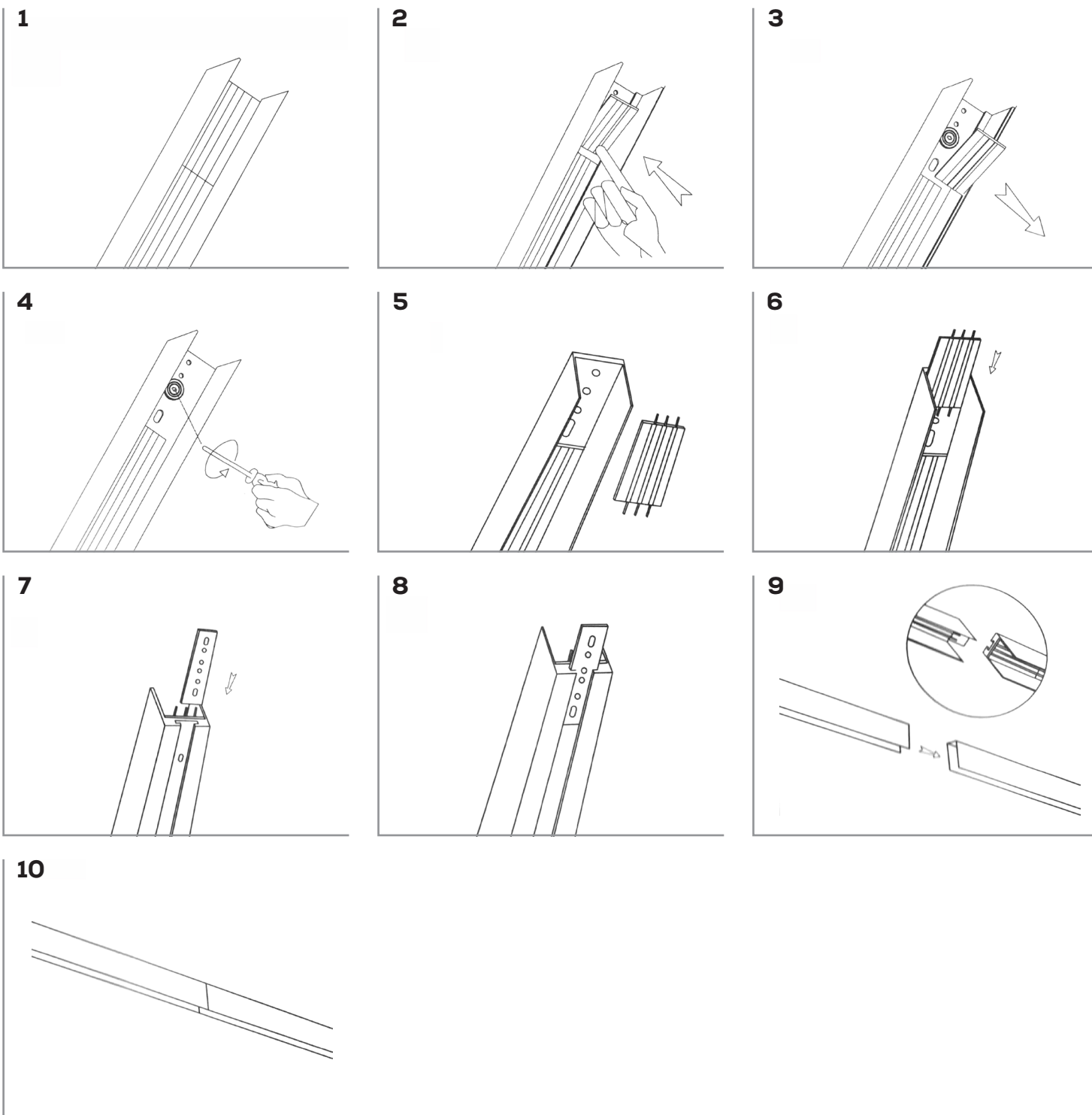

TITANIUM

TECHNOLOGY

Track connection with connector

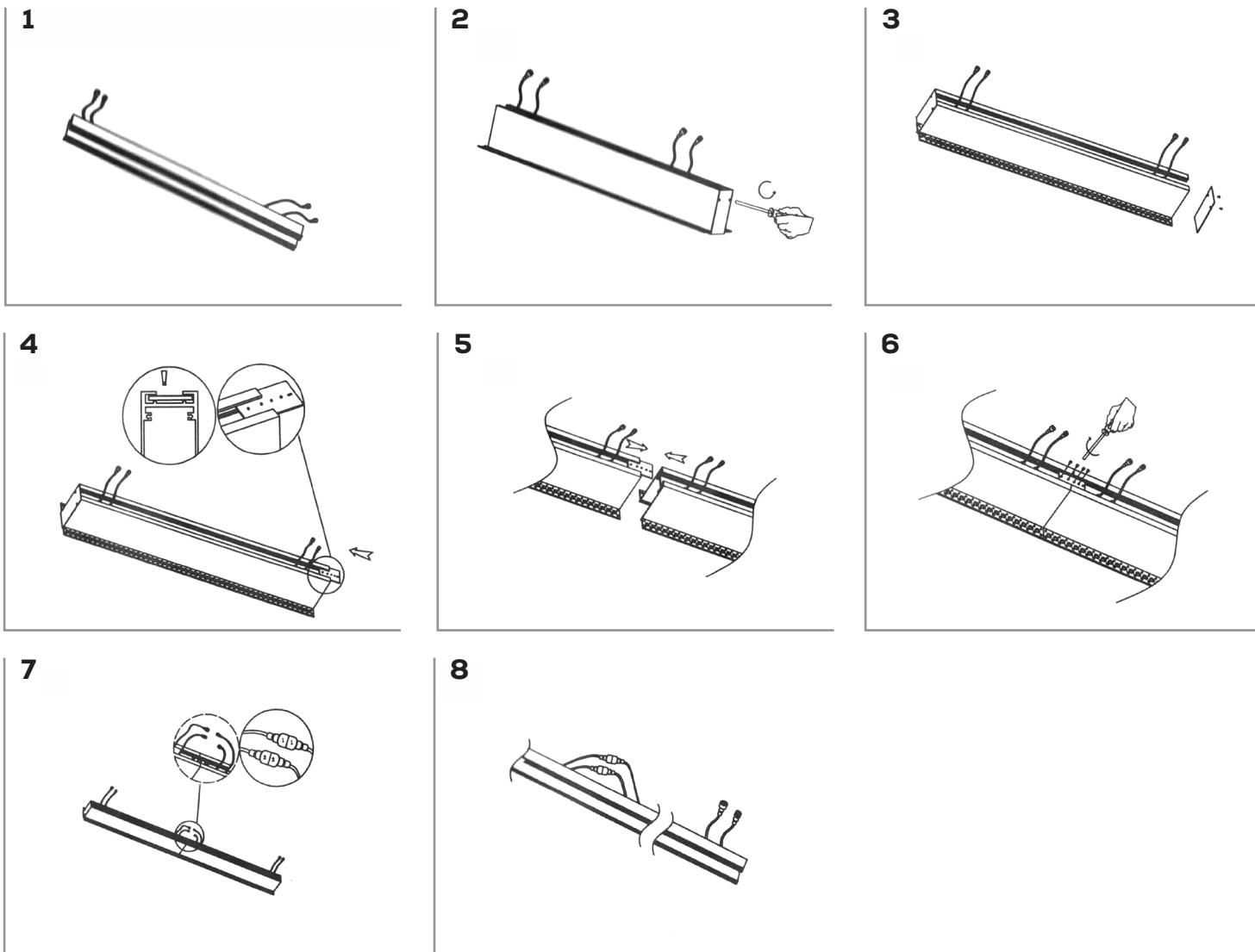

Run Length	Segment breakdown
65 mm	65
130 mm	65 + 65
140 mm	140
195 mm	65 + 65 + 65
205 mm	140 + 65
270 mm	140 + 65 + 65
280 mm	140 + 140
335 mm	140 + 65 + 65 + 65
345 mm	140 + 140 + 65
410 mm	140 + 140 + 65 + 65
420 mm	140 + 140 + 140
465 mm	465
530 mm	465 + 65
595 mm	465 + 65 + 65
605 mm	465 + 140
660 mm	465 + 65 + 65 + 65
670 mm	465 + 140 + 65
735 mm	465 + 140 + 65 + 65
745 mm	465 + 140 + 140
800 mm	465 + 140 + 65 + 65 + 65
810 mm	465 + 140 + 140 + 65
875 mm	465 + 140 + 140 + 65 + 65
885 mm	465 + 140 + 140 + 140
930 mm	465 + 465
995 mm	465 + 465 + 65
1060 mm	465 + 465 + 65 + 65
1070 mm	465 + 465 + 140
1125 mm	465 + 465 + 65 + 65 + 65
1135 mm	465 + 465 + 140 + 65

Run Length	Segment breakdown
1200 mm	465 + 465 + 140 + 65 + 65
1210 mm	465 + 465 + 140 + 140
1265 mm	465 + 465 + 140 + 65 + 65 + 65
1275 mm	465 + 465 + 140 + 140 + 65
1340 mm	465 + 465 + 140 + 140 + 65 + 65
1350 mm	465 + 465 + 140 + 140 + 140
1395 mm	465 + 465 + 465
1460 mm	465 + 465 + 465 + 65
1525 mm	465 + 465 + 465 + 65 + 65
1535 mm	465 + 465 + 465 + 140
1590 mm	465 + 465 + 465 + 65 + 65 + 65
1600 mm	465 + 465 + 465 + 140 + 65
1665 mm	465 + 465 + 465 + 140 + 65 + 65
1675 mm	465 + 465 + 465 + 140 + 140
1730 mm	465 + 465 + 465 + 140 + 65 + 65 + 65
1740 mm	465 + 465 + 465 + 140 + 140 + 65
1805 mm	465 + 465 + 465 + 140 + 140 + 65 + 65
1815 mm	465 + 465 + 465 + 140 + 140 + 140
1860 mm	465 + 465 + 465 + 465
1925 mm	465 + 465 + 465 + 465 + 65
1990 mm	465 + 465 + 465 + 465 + 65 + 65
2000 mm	465 + 465 + 465 + 465 + 140
2055 mm	465 + 465 + 465 + 465 + 65 + 65 + 65
2065 mm	465 + 465 + 465 + 465 + 140 + 65
2130 mm	465 + 465 + 465 + 465 + 140 + 65 + 65
2140 mm	465 + 465 + 465 + 465 + 140 + 140
2195 mm	465 + 465 + 465 + 465 + 140 + 65 + 65 + 65
2205 mm	465 + 465 + 465 + 465 + 140 + 140 + 65
2270 mm	465 + 465 + 465 + 465 + 140 + 140 + 65 + 65

Run Length	Segment breakdown
2280 mm	465 + 465 + 465 + 465 + 140 + 140 + 140
2325 mm	465 + 465 + 465 + 465 + 465
2390 mm	465 + 465 + 465 + 465 + 465 + 65
2455 mm	465 + 465 + 465 + 465 + 465 + 65 + 65
2465 mm	465 + 465 + 465 + 465 + 465 + 140
2520 mm	465 + 465 + 465 + 465 + 465 + 65 + 65 + 65
2530 mm	465 + 465 + 465 + 465 + 465 + 140 + 65
2595 mm	465 + 465 + 465 + 465 + 465 + 140 + 65 + 65
2605 mm	465 + 465 + 465 + 465 + 465 + 140 + 140
2660 mm	465 + 465 + 465 + 465 + 465 + 140 + 65 + 65 + 65
2670 mm	465 + 465 + 465 + 465 + 465 + 140 + 140 + 65
2735 mm	465 + 465 + 465 + 465 + 465 + 140 + 140 + 65 + 65
2745 mm	465 + 465 + 465 + 465 + 465 + 140 + 140 + 140
2790 mm	465 + 465 + 465 + 465 + 465 + 465
2855 mm	465 + 465 + 465 + 465 + 465 + 465 + 65
2920 mm	465 + 465 + 465 + 465 + 465 + 465 + 65 + 65
2930 mm	465 + 465 + 465 + 465 + 465 + 465 + 140
2985 mm	465 + 465 + 465 + 465 + 465 + 465 + 65 + 65 + 65
2995 mm	465 + 465 + 465 + 465 + 465 + 465 + 140 + 65

PATTERN TYPICAL SEGMENT BREAKDOWN IN MM

This section is to detail how each linear runs of your patterns will be divided in standard length segments.

End caps of 2.5mm each are not included in run length calculations.

TITANIUM

TECHNOLOGY

Dimensions are always calculated from the center of the aircraft cable.

Refer to aircraft cable installation sheet to properly install your mounting points.

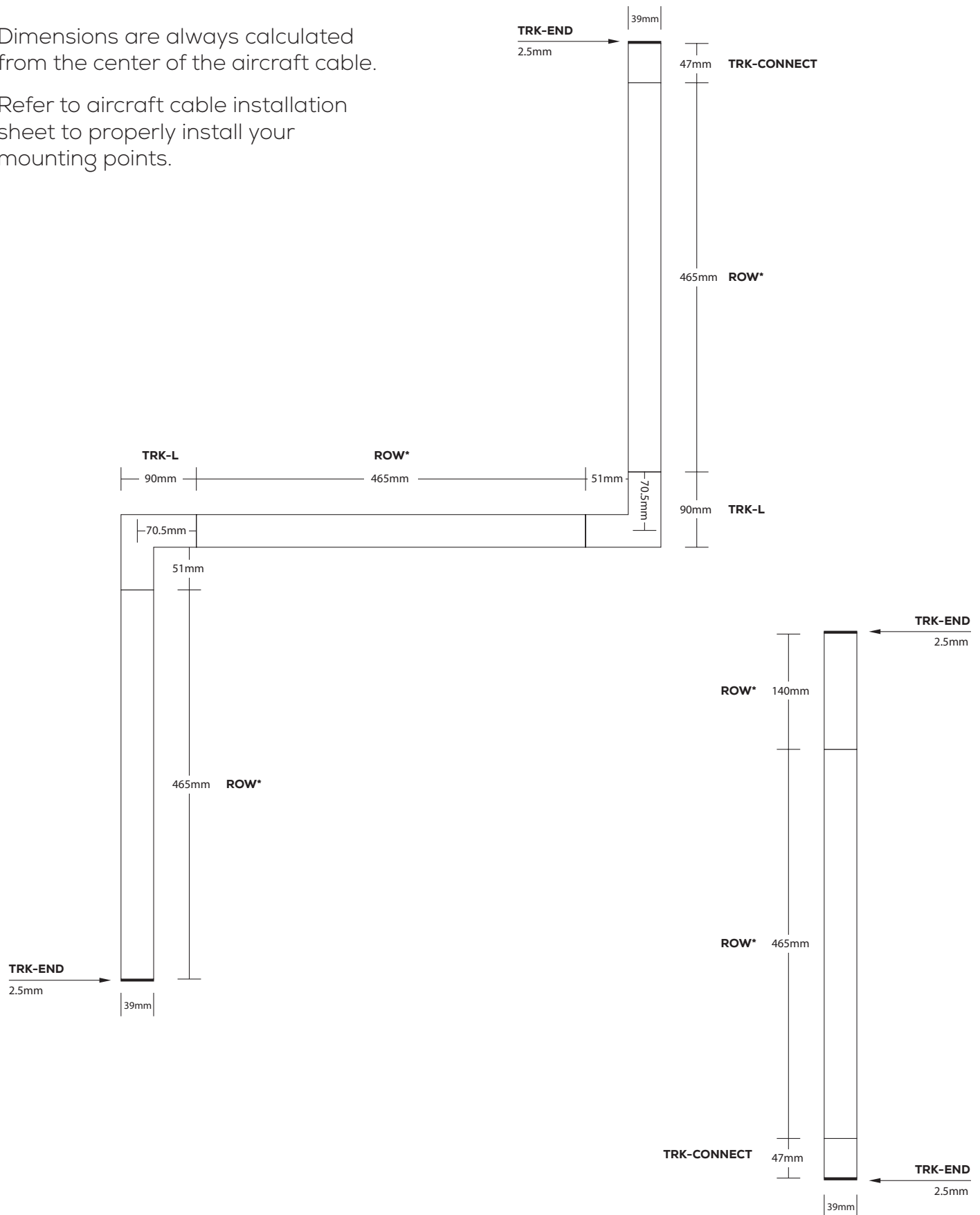

*Please refer to page 80 in the run length section to select your desired row length.

Dimensions are always calculated from the center of the aircraft cable.

Refer to aircraft cable installation sheet to properly install your mounting points.

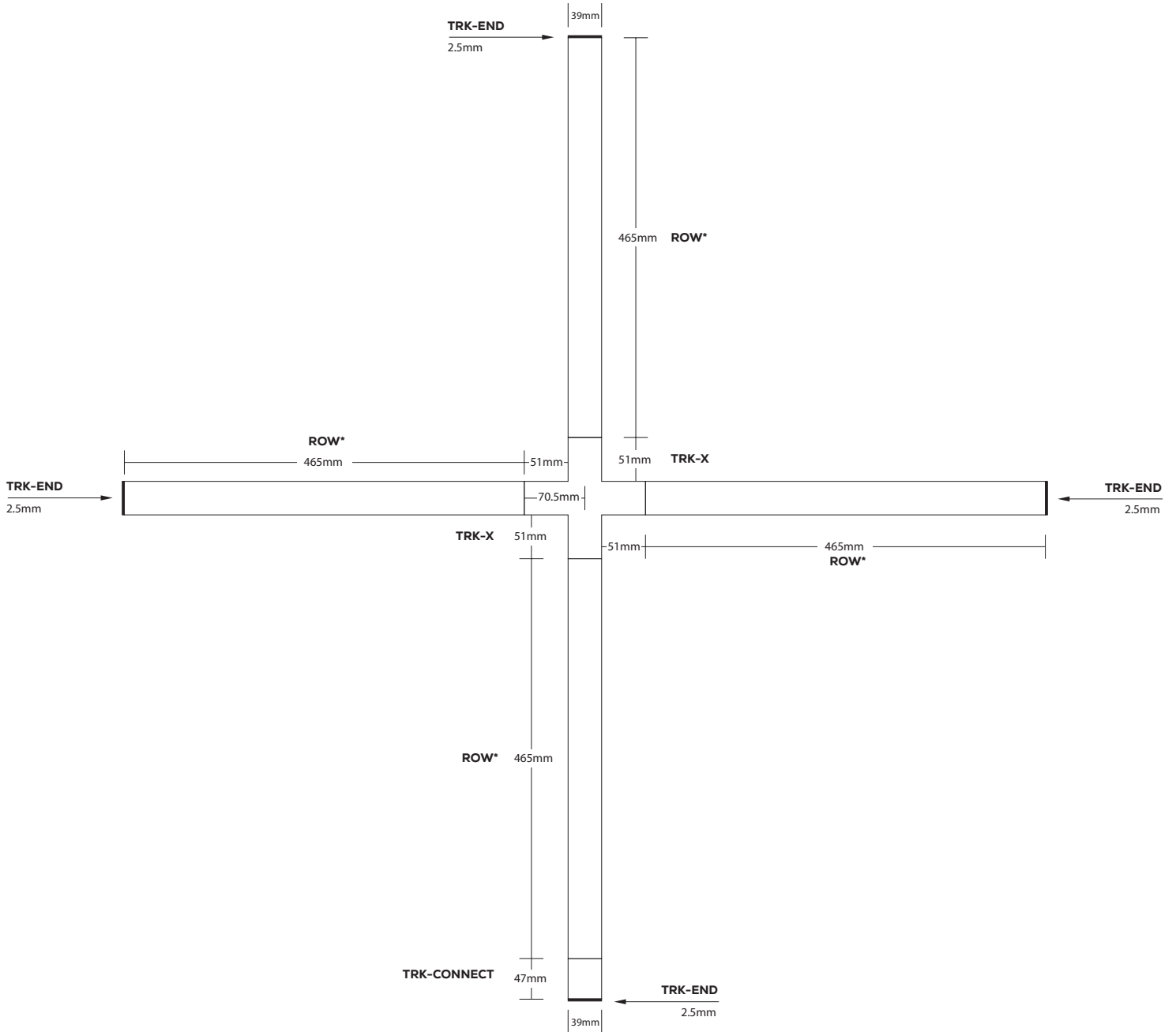

*Please refer to page 80 in the run length section to select your desired row length.

Dimensions are always calculated from the center of the aircraft cable.

Refer to aircraft cable installation sheet to properly install your mounting points.

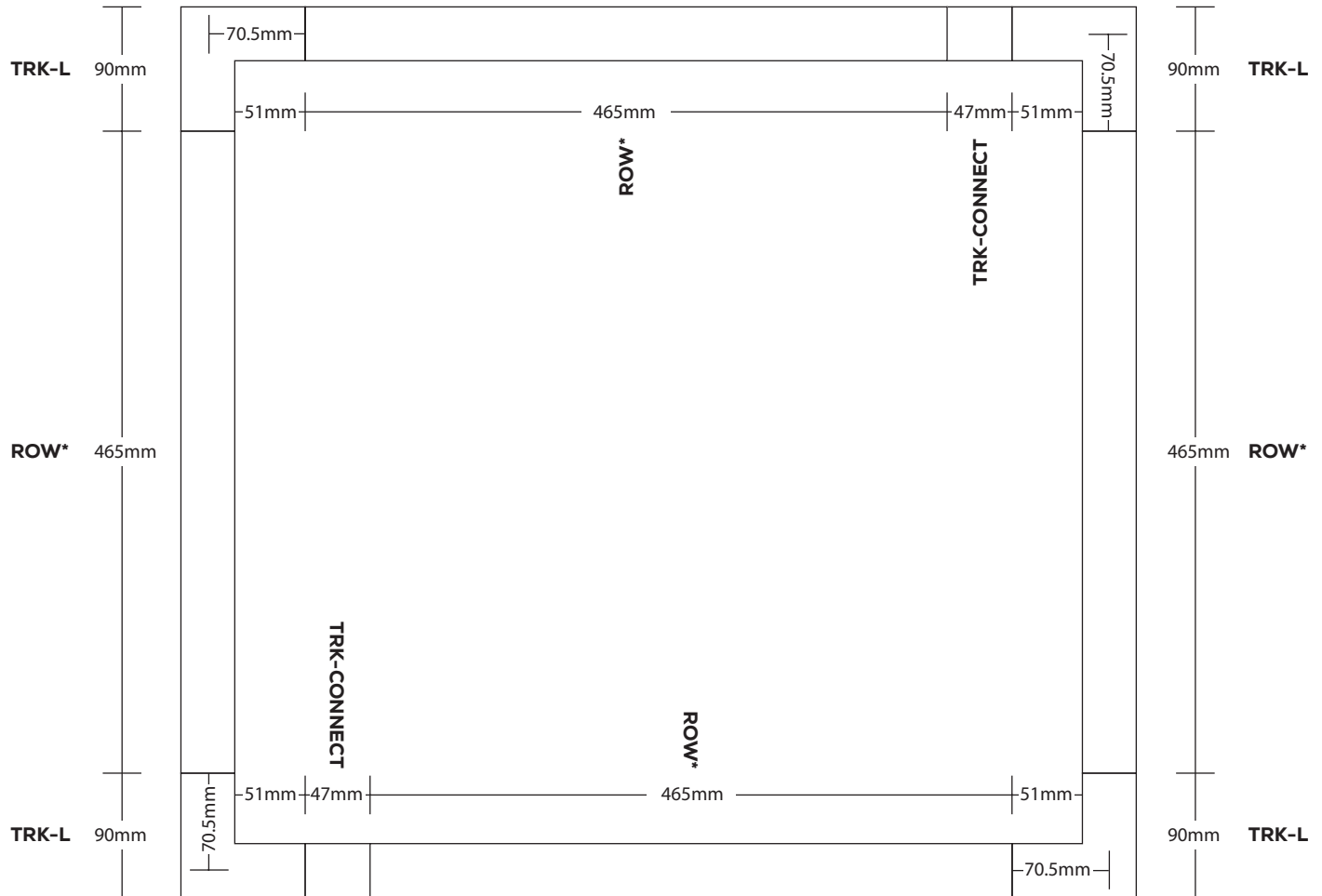

*Please refer to page 80 in the run length section to select your desired row length.

PRODUCT BUILDER CODE

TYPE	END CAP	SUSPENSION	CONNECT
SU Surface	END Yes	SUSP Yes	24V
PL Trimless mud-in	N/A No	N/A No	

RUN LENGTH DIMENSION (mm)	+	JUNCTION	+	RUN LENGTH DIMENSION (mm)	+	JUNCTION	+	RUN LENGTH DIMENSION (mm)	ETC ...
Refer to the table on page 80		L X T R1/8 R1/4 R1/2		Refer to the table on page 80		L X T R1/8 R1/4 R1/2		Refer to the table on page 80	

BUILD YOUR CODE

TYPE	END CAP	SUSPENSION	CONNECT

RUN LENGTH DIMENSION (mm)	+	JUNCTION	+	RUN LENGTH DIMENSION (mm)	+	JUNCTION	+	RUN LENGTH DIMENSION (mm)

JUNCTION	+	RUN LENGTH DIMENSION (mm)	+	JUNCTION	+	RUN LENGTH DIMENSION (mm)	+	JUNCTION

RUN LENGTH DIMENSION (mm)	+	JUNCTION	+	RUN LENGTH DIMENSION (mm)	+	JUNCTION	+	RUN LENGTH DIMENSION (mm)

Inches (decimal)	Inches (Fraction)	Millimeters	Inches (decimal)	Inches (Fraction)	Millimeters	Inches (decimal)	Inches (Fraction)	Millimeters	Inches (decimal)	Inches (Fraction)	Millimeters	Inches (decimal)	Inches (Fraction)	Millimeters
0.0625	1/16	1.5875	1.0625	1 1/16	26.9876	2.0625	2 1/16	52.3877	3.0625	3 1/16	77.7878	4.0625	4 1/16	103.1879
0.1250	1/8	3.1750	1.1250	1 1/8	28.5751	2.1250	2 1/8	53.9752	3.1250	3 1/8	79.3753	4.1250	4 1/8	104.7754
0.1875	3/16	4.7625	1.1875	1 3/16	30.1626	2.1875	2 3/16	55.5627	3.1875	3 3/16	80.9628	4.1875	4 3/16	106.3629
0.2500	1/4	6.3500	1.2500	1 1/4	31.7501	2.2500	2 1/4	57.1502	3.2500	3 1/4	82.5503	4.2500	4 1/4	107.9504
0.3125	5/16	7.9375	1.3125	1 5/16	33.3376	2.3125	2 5/16	58.7377	3.3125	3 5/16	84.1378	4.3125	4 5/16	109.5379
0.3750	3/8	9.5250	1.3750	1 3/8	34.9251	2.3750	2 3/8	60.3252	3.3750	3 3/8	85.7253	4.3750	4 3/8	111.1254
0.4375	7/16	11.1125	1.4375	1 7/16	36.5126	2.4375	2 7/16	61.9127	3.4375	3 7/16	87.3128	4.4375	4 7/16	112.7129
0.5000	1/2	12.7001	1.5000	1 1/2	38.1002	2.5000	2 1/2	63.5003	3.5000	3 1/2	88.9004	4.5000	4 1/2	114.3005
0.5625	9/16	14.2876	1.5625	1 9/16	39.6877	2.5625	2 9/16	65.0878	3.5625	3 9/16	90.4879	4.5625	4 9/16	115.8880
0.6250	5/8	15.8751	1.6250	1 5/8	41.2752	2.6250	2 5/8	66.6753	3.6250	3 5/8	92.0754	4.6250	4 5/8	117.4755
0.6875	11/16	17.4626	1.6875	1 11/16	42.8627	2.6875	2 11/16	68.2628	3.6875	3 11/16	93.6629	4.6875	4 11/16	119.0630
0.7500	3/4	19.0501	1.7500	1 3/4	44.4502	2.7500	2 3/4	69.8503	3.7500	3 3/4	95.2504	4.7500	4 3/4	120.6505
0.8125	13/16	20.6376	1.8125	1 13/16	46.0377	2.8125	2 13/16	71.4378	3.8125	3 13/16	96.8379	4.8125	4 13/16	122.2380
0.8750	7/8	22.2251	1.8750	1 7/8	47.6252	2.8750	2 7/8	73.0253	3.8750	3 7/8	98.4254	4.8750	4 7/8	123.8255
0.9375	15/16	23.8126	1.9375	1 15/16	49.2127	2.9375	2 15/16	74.6128	3.9375	3 15/16	100.0129	4.9375	4 15/16	125.4130
1.0000	1	25.4001	2.0000	2	50.8002	3.0000	3	76.2003	4.0000	4	101.6004	5.0000	5	127.0005

Inches (decimal)	Inches (Fraction)	Millimeters	Inches (decimal)	Inches (Fraction)	Millimeters	Inches (decimal)	Inches (Fraction)	Millimeters	Inches (decimal)	Inches (Fraction)	Millimeters	Inches (decimal)	Inches (Fraction)	Millimeters
5.0625	5 1/16	128.5880	6.0625	6 1/16	153.9881	7.0625	7 1/16	179.3882	8.0625	8 1/16	204.7883	9.0625	9 1/16	230.1884
5.1250	5 1/8	130.1755	6.1250	6 1/8	155.5756	7.1250	7 1/8	180.9757	8.1250	8 1/8	206.3758	9.1250	9 1/8	231.7759
5.1875	5 3/16	131.7630	6.1875	6 3/16	157.1631	7.1875	7 3/16	182.5632	8.1875	8 3/16	207.9633	9.1875	9 3/16	233.3634
5.2500	5 1/4	133.3505	6.2500	6 1/4	158.7506	7.2500	7 1/4	184.1507	8.2500	8 1/4	209.5508	9.2500	9 1/4	234.9509
5.3125	5 5/16	134.9380	6.3125	6 5/16	160.3381	7.3125	7 5/16	185.7382	8.3125	8 5/16	211.1383	9.3125	9 5/16	236.5384
5.3750	5 3/8	136.5255	6.3750	6 3/8	161.9256	7.3750	7 3/8	187.3257	8.3750	8 3/8	212.7258	9.3750	9 3/8	238.1259
5.4375	5 7/16	138.1130	6.4375	6 7/16	163.5131	7.4375	7 7/16	188.9132	8.4375	8 7/16	214.3133	9.4375	9 7/16	239.7134
5.5000	5 1/2	139.7006	6.5000	6 1/2	165.1007	7.5000	7 1/2	190.5008	8.5000	8 1/2	215.9009	9.5000	9 1/2	241.3010
5.5625	5 9/16	141.2881	6.5625	6 9/16	166.6882	7.5625	7 9/16	192.0883	8.5625	8 9/16	217.4884	9.5625	9 9/16	242.8885
5.6250	5 5/8	142.8756	6.6250	6 5/8	168.2757	7.6250	7 5/8	193.6758	8.6250	8 5/8	219.0759	9.6250	9 5/8	244.4760
5.6875	5 11/16	144.4631	6.6875	6 11/16	169.8632	7.6875	7 11/16	195.2633	8.6875	8 11/16	220.6634	9.6875	9 11/16	246.0635
5.7500	5 3/4	146.0506	6.7500	6 3/4	171.4507	7.7500	7 3/4	196.8508	8.7500	8 3/4	222.2509	9.7500	9 3/4	247.6510
5.8125	5 13/16	147.6381	6.8125	6 13/16	173.0382	7.8125	7 13/16	198.4383	8.8125	8 13/16	223.8384	9.8125	9 13/16	249.2385
5.8750	5 7/8	149.2256	6.8750	6 7/8	174.6257	7.8750	7 7/8	200.0258	8.8750	8 7/8	225.4259	9.8750	9 7/8	250.8260
5.9375	5 15/16	150.8131	6.9375	6 15/16	176.2132	7.9375	7 15/16	201.6133	8.9375	8 15/16	227.0134	9.9375	9 15/16	252.4135
6.0000	6	152.4006	7.0000	7	177.8007	8.0000	8	203.2008	9.0000	9	228.6009	10.0000	10	254.0010

Inches (decimal)	Inches (Fraction)	Millimeters	Inches (decimal)	Inches (Fraction)	Millimeters	Inches (decimal)	Inches (Fraction)	Millimeters	Inches (decimal)	Inches (Fraction)	Millimeters	Inches (decimal)	Inches (Fraction)	Millimeters
10.0625	10 1/16	255.5885	11.0625	11 1/16	280.9886	12.0625	12 1/16	306.3887	13.0625	13 1/16	331.7888	14.0625	14 1/16	357.1889
10.1250	10 1/8	257.1760	11.1250	11 1/8	282.5761	12.1250	12 1/8	307.9762	13.1250	13 1/8	333.3763	14.1250	14 1/8	358.7764
10.1875	10 3/16	258.7635	11.1875	11 3/16	284.1636	12.1875	12 3/16	309.5637	13.1875	13 3/16	334.9638	14.1875	14 3/16	360.3639
10.2500	10 1/4	260.3510	11.2500	11 1/4	285.7511	12.2500	12 1/4	311.1512	13.2500	13 1/4	336.5513	14.2500	14 1/4	361.9514
10.3125	10 5/16	261.9385	11.3125	11 5/16	287.3386	12.3125	12 5/16	312.7387	13.3125	13 5/16	338.1388	14.3125	14 5/16	363.5389
10.3750	10 3/8	263.5260	11.3750	11 3/8	288.9261	12.3750	12 3/8	314.3262	13.3750	13 3/8	339.7263	14.3750	14 3/8	365.1264
10.4375	10 7/16	265.1135	11.4375	11 7/16	290.5136	12.4375	12 7/16	315.9137	13.4375	13 7/16	341.3138	14.4375	14 7/16	366.7139
10.5000	10 1/2	266.7010	11.5000	11 1/2	292.1012	12.5000	12 1/2	317.5013	13.5000	13 1/2	342.9014	14.5000	14 1/2	368.3015
10.5625	10 9/16	268.2886	11.5625	11 9/16	293.6887	12.5625	12 9/16	319.0888	13.5625	13 9/16	344.4889	14.5625	14 9/16	369.8890
10.6250	10 5/8	269.8761	11.6250	11 5/8	295.2762	12.6250	12 5/8	320.6763	13.6250	13 5/8	346.0764	14.6250	14 5/8	371.4765
10.6875	10 11/16	271.4636	11.6875	11 11/16	296.8637	12.6875	12 11/16	322.2638	13.6875	13 11/16	347.6639	14.6875	14 11/16	373.0640
10.7500	10 3/4	273.0511	11.7500	11 3/4	298.4512	12.7500	12 3/4	323.8513	13.7500	13 3/4	349.2514	14.7500	14 3/4	374.6515
10.8125	10 13/16	274.6386	11.8125	11 13/16	300.0387	12.8125	12 13/16	325.4388	13.8125	13 13/16	350.8389	14.8125	14 13/16	376.2390
10.8750	10 7/8	276.2261	11.8750	11 7/8	301.6262	12.8750	12 7/8	327.0263	13.8750	13 7/8	352.4264	14.8750	14 7/8	377.8265
10.9375	10 15/16	277.8136	11.9375	11 15/16	303.2137	12.9375	12 15/16	328.6138	13.9375	13 15/16	354.0139	14.9375	14 15/16	379.4140
11.0000	11	279.4011	12.0000	12	304.8012	13.0000	13	330.2013	14.0000	14	355.6014	15.0000	15	381.0015

Inches (decimal)	Inches (Fraction)	Millimeters	Inches (decimal)	Inches (Fraction)	Millimeters	Inches (decimal)	Inches (Fraction)	Millimeters	Inches (decimal)	Inches (Fraction)	Millimeters	Inches (decimal)	Inches (Fraction)	Millimeters
15.0625	15 1/16	382.5890	16.0625	16 1/16	407.9891	17.0625	17 1/16	433.3892	18.0625	18 1/16	458.7893	19.0625	19 1/16	484.1894
15.1250	15 1/8	384.1765	16.1250	16 1/8	409.5766	17.1250	17 1/8	434.9767	18.1250	18 1/8	460.3768	19.1250	19 1/8	485.7769
15.1875	15 3/16	385.7640	16.1875	16 3/16	411.1641	17.1875	17 3/16	436.5642	18.1875	18 3/16	461.9643	19.1875	19 3/16	487.3644
15.2500	15 1/4	387.3515	16.2500	16 1/4	412.7516	17.2500	17 1/4	438.1517	18.2500	18 1/4	463.5518	19.2500	19 1/4	488.9519
15.3125	15 5/16	388.9390	16.3125	16 5/16	414.3391	17.3125	17 5/16	439.7392	18.3125	18 5/16	465.1393	19.3125	19 5/16	490.5394
15.3750	15 3/8	390.5265	16.3750	16 3/8	415.9266	17.3750	17 3/8	441.3267	18.3750	18 3/8	466.7268	19.3750	19 3/8	492.1269
15.4375	15 7/16	392.1140	16.4375	16 7/16	417.5141	17.4375	17 7/16	442.9142	18.4375	18 7/16	468.3143	19.4375	19 7/16	493.7144
15.5000	15 1/2	393.7015	16.5000	16 1/2	419.1017	17.5000	17 1/2	444.5018	18.5000	18 1/2	469.9019	19.5000	19 1/2	495.3020
15.5625	15 9/16	395.2890	16.5625	16 9/16	420.6892	17.5625	17 9/16	446.0893	18.5625	18 9/16	471.4894	19.5625	19 9/16	496.8895
15.6250	15 5/8	396.8766	16.6250	16 5/8	422.2767	17.6250	17 5/8	447.6768	18.6250	18 5/8	473.0769	19.6250	19 5/8	498.4770
15.6875	15 11/16	398.4641	16.6875	16 11/16	423.8642	17.6875	17 11/16	449.2643	18.6875	18 11/16	474.6644	19.6875	19 11/16	500.0645
15.7500	15 3/4	400.0516	16.7500	16 3/4	425.4517	17.7500	17 3/4	450.8518	18.7500	18 3/4	476.2519	19.7500	19 3/4	501.6520
15.8125	15 13/16	401.6391	16.8125	16 13/16	427.0392	17.8125	17 13/16	452.4393	18.8125	18 13/16	477.8394	19.8125	19 13/16	503.2395
15.8750	15 7/8	403.2266	16.8750	16 7/8	428.6267	17.8750	17 7/8	454.0268	18.8750	18 7/8	479.4269	19.8750	19 7/8	504.8270
15.9375	15 15/16	404.8141	16.9375	16 15/16	430.2142	17.9375	17 15/16	455.6143	18.9375	18 15/16	481.0144	19.9375	19 15/16	506.4145
16.0000	16	406.4016	17.0000	17	431.8017	18.0000	18	457.2018	19.0000	19	482.6019	20.0000	20	508.0020

LIMITED TWO (2) YEARS WARRANTY



Titanium Technology offers this limited warranty for two (2) years from the date of purchase of this Titanium Technology product (hereafter : the «Product»). A list of all the Titanium Technology products covered by this limited warranty is given at the end of this document.

This limited warranty is valid only for the Product and it may not be transferred.

The present limited warranty is not meant to exclude, restrict, limit or modify the legal warranty given by law to the purchaser of the Product.

This is a quality Product. It was made and selected with care. If the Product contains a manufacturing defect or if one or more parts of the Product is defective, the retailer commits to replace or repair, at its sole discretion, the defective part of parts without charge under the following cumulative conditions : 1) the purchaser must contact the retail store where the Product was purchased; 2) the purchaser must return the defective part of parts or the Product to the retailer; 3) the purchaser must provide the retailer the invoice as proof of purchase and date of purchase of the Product; 4) the purchaser must supply the Product identification information, including the serial number or the model number; and 5) the period of two (2) years covered by this limited warranty must not be expired. If the retailer decides to replace the defective part or parts, the replacement part or parts would be new or reconditioned, equivalent to new parts.

EXCLUSIONS AND LIMITATIONS OF THE LIMITED WARRANTY

This limited warranty is not applicable :

1. to consumable parts;
2. to normal wear;
3. when the Product is used for purposes other than those determined by the manufacturer;
4. when the Product is not installed by a qualified electrician when electrical work is required;
5. when the serial number or other identification information or the Product is erased or withdrawn;
6. to damages that are only aesthetic and do not affect the normal use of the Product, including scratches, bumps etc.;
7. to labour costs such as installation, de-installation or shipping of the Product which must be paid by the purchaser;
8. to service call costs, when the service call is made while the warranty is not valid;
9. when the damages, defects, faults or other problems arise from :
 - a. an abnormal use of the Product;
 - b. an inadequate maintenance of the Product;
 - c. a faulty installation of the Product or an installation that is not in accordance with the installation guide (if one is provided);
 - d. a modification, a repair or dismantling of the Product by a person not authorized by the retailer or the manufacturer;
 - e. the transportation by the purchaser, his employee, officer or representative;
 - f. a negligence by the purchaser, his employee, officer or representative;
 - g. an accident;
 - h. a case of force majeure (are considered force majeure : nature disasters, lightning, flood, fire etc.);
 - i. any event that is not caused by the Product itself.

In no circumstance can the manufacturer or retailer be held responsible for any extraordinary, special, indirect, accessory or consecutive damages resulting from the use of or the incapacity to use the Product. Their responsibility is limited to the sale price of the Product as indicated on the notice and paid by the purchaser at the time of purchase. It is understood that this is not meant to limit, restrict or exclude the protection given by the legal warranty.

FRENCH VERSION VS ENGLISH VERSION

In case of discrepancy between the French and the English versions of the text of this limited warranty, the French version shall prevail.

MODIFICATIONS

The present warranty text is subject to change at any time.

List of Titanium Technology products covered under this limited warranty :

- | | |
|------------------------------|--------------|
| 1) TT-LUS-XX | 4)TT-STEP-XX |
| 2) TT-PSU-IP67-XX (MEANWELL) | 5)TT-UGD-XX |
| 3) TT-TRK-XX | |

Note : This product list may not be up to date. Please refer to the product itself (including the package or installation guide) to make sure it is covered by this limited warranty.

TITANIUM

TECHNOLOGY

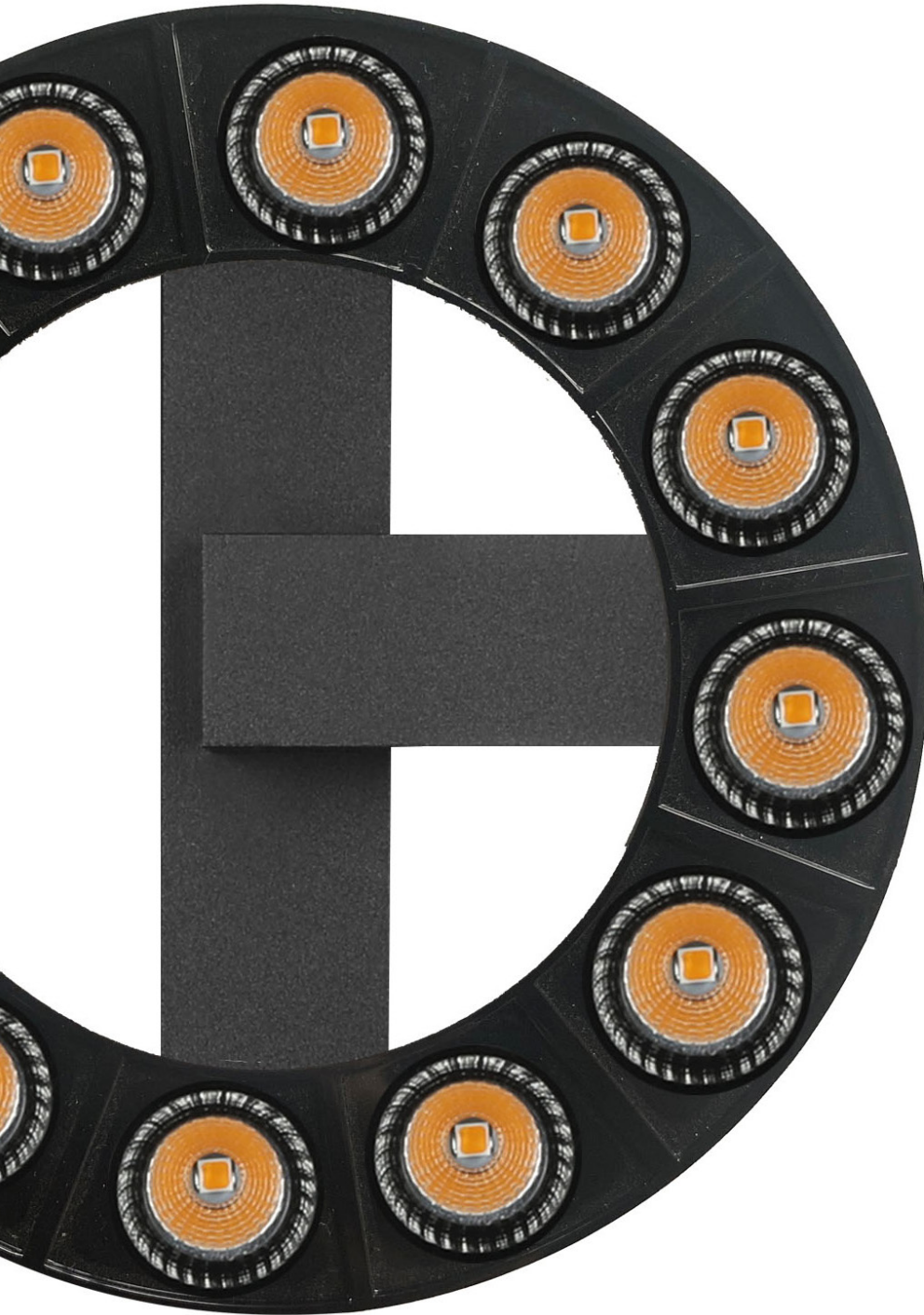

TITANIUM TECHNOLOGY
2323, boulevard Versant Nord #111
Québec, QC
G1N 4P4 CANADA
Toll free (866)-476-8115
www.titaniumtechnology.com
sales@titaniumtechnology.com
www.facebook.com/titaniumtechnologie

TITANIUM TECHNOLOGY USA
NEWARK DE 19713
Toll free (866)-476-8115 ext.203
www.titaniumtechnology.com
sales@titaniumtechnology.com
www.facebook.com/titaniumtechnologie