

TITANIUM

TECHNOLOGY

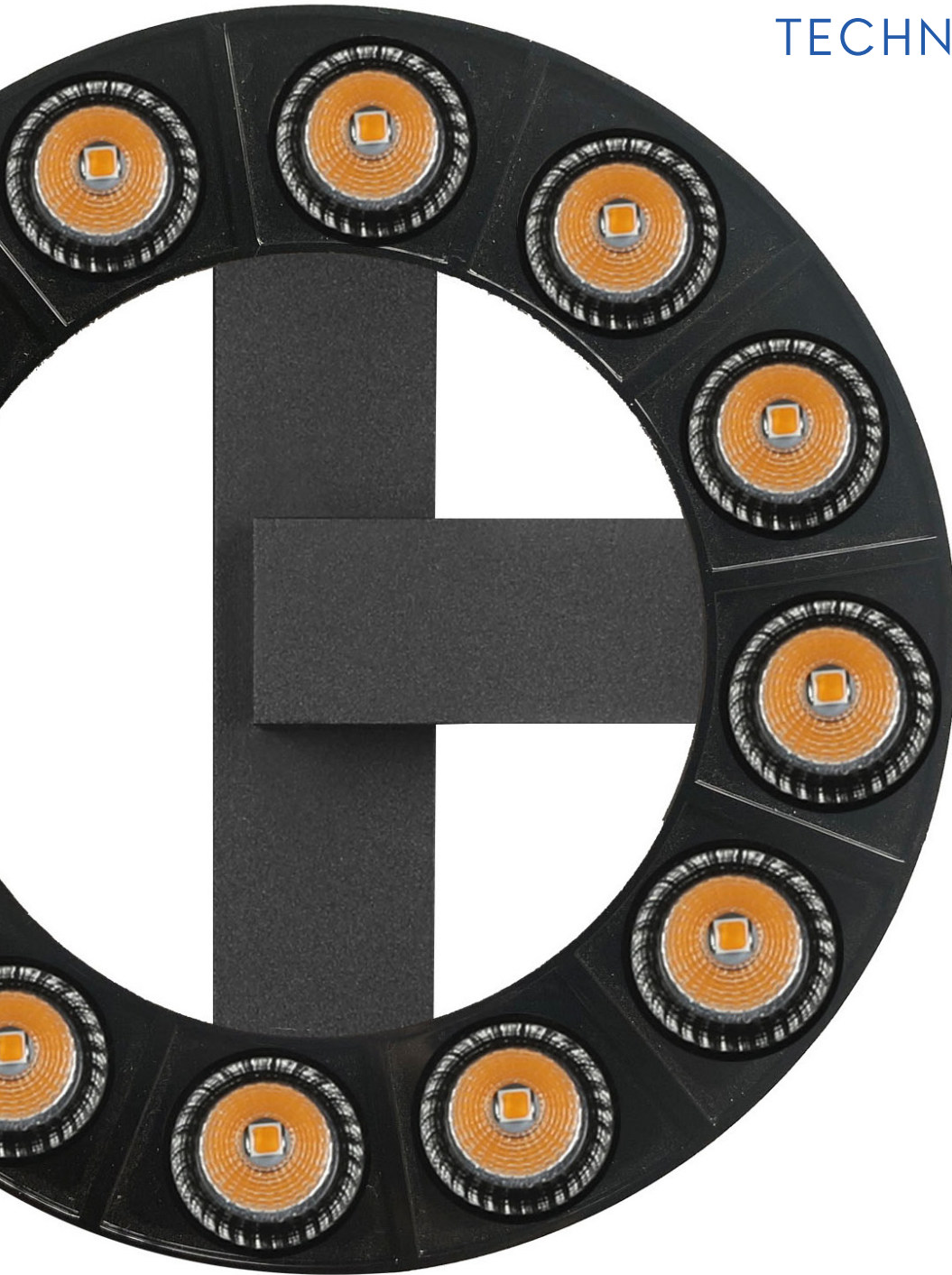

Track Lighting system
2022

TT-TRK-TRACK Page 8

Voltage (vDC)	Power (W/m)	Luminous flux (lm/m)	Angle beam (°)
24	-	-	-



TT-TRK-TRACK-PL Page 9

Voltage (vDC)	Power (W/m)	Luminous flux (lm/m)	Angle beam (°)
24	-	-	-



TT-TRK-1X1 Page 10

Voltage (vDC)	Power (W/m)	Luminous flux (lm/m)	Angle beam (°)
24	2	120	34



TT-TRK-3X1 Page 11

Voltage (vDC)	Power (W/m)	Luminous flux (lm/m)	Angle beam (°)
24	4	380	34



TT-TRK-6X1 Page 12

Voltage (vDC)	Power (W/m)	Luminous flux (lm/m)	Angle beam (°)
24	8	790	34



TT-TRK-12X1 Page 13

Voltage (vDC)	Power (W/m)	Luminous flux (lm/m)	Angle beam (°)
24	16	1550	34



TT-TRK-3X1D Page 14

Voltage (vDC)	Power (W/m)	Luminous flux (lm/m)	Angle beam (°)
24	4	380	34



TT-TRK-6X1D Page 15

Voltage (vDC)	Power (W/m)	Luminous flux (lm/m)	Angle beam (°)
24	8	790	34



TT-TRK-12X1D Page 16

Voltage (vDC)	Power (W/m)	Luminous flux (lm/m)	Angle beam (°)
24	16	1550	34



TITANIUM

TECHNOLOGY



TT-TRK-322 Page 17

Voltage (vDC)	Power (W/m)	Luminous flux (lm/m)	Angle beam (°)
24	13	980	120



TT-TRK-640 Page 18

Voltage (vDC)	Power (W/m)	Luminous flux (lm/m)	Angle beam (°)
24	26	1900	120



TT-TRK-958 Page 19

Voltage (vDC)	Power (W/m)	Luminous flux (lm/m)	Angle beam (°)
24	39	2850	120

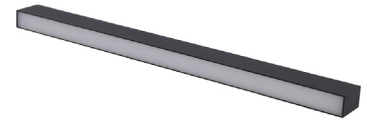

TT-TRK-84D Page 20

Voltage (vDC)	Power (W/m)	Luminous flux (lm/m)	Angle beam (°)
24	4	280	120



TT-TRK-164D Page 21

Voltage (vDC)	Power (W/m)	Luminous flux (lm/m)	Angle beam (°)
24	8	500	120



TT-TRK-323D Page 22

Voltage (vDC)	Power (W/m)	Luminous flux (lm/m)	Angle beam (°)
24	16	980	120



TT-TRK-BALL Page 23

Voltage (vDC)	Power (W/m)	Luminous flux (lm/m)	Angle beam (°)
24	5	290	360



TT-TRK-15 Page 24

Voltage (vDC)	Power (W/m)	Luminous flux (lm/m)	Angle beam (°)
24	8	380	120



TT-TRK-30 Page 25

Voltage (vDC)	Power (W/m)	Luminous flux (lm/m)	Angle beam (°)
24	16	880	120





TT-TRK-5W-1 Page 26

Voltage (vDC)	Power (W/m)	Luminous flux (lm/m)	Angle beam (°)
24	5	440	40



TT-TRK-5W-2 Page 27

Voltage (vDC)	Power (W/m)	Luminous flux (lm/m)	Angle beam (°)
24	2 x 5W	880	40



TT-TRK-8W-1 Page 28

Voltage (vDC)	Power (W/m)	Luminous flux (lm/m)	Angle beam (°)
24	8	405	20



TT-TRK-10W-1 Page 29

Voltage (vDC)	Power (W/m)	Luminous flux (lm/m)	Angle beam (°)
24	10	780	24



TT-TRK-15W-1 Page 30

Voltage (vDC)	Power (W/m)	Luminous flux (lm/m)	Angle beam (°)
24	15	905	20



TT-TRK-20W-1 Page 31

Voltage (vDC)	Power (W/m)	Luminous flux (lm/m)	Angle beam (°)
24	20	1450	24



TT-TRK-10W-1Z Page 32

Voltage (vDC)	Power (W/m)	Luminous flux (lm/m)	Angle beam (°)
24	10	780	200



TT-TRK-120C Page 33

Voltage (vDC)	Power (W/m)	Luminous flux (lm/m)	Angle beam (°)
24	12	650	Diffuse



TT-TRK-164C Page 34

Voltage (vDC)	Power (W/m)	Luminous flux (lm/m)	Angle beam (°)
24	12	650	Diffuse





TT-TRK-12X1W-C Page 35

Voltage (vDC)	Power (W/m)	Luminous flux (lm/m)	Angle beam (°)
24	12	1150	34



TT-TRK-18X1W-C Page 36

Voltage (vDC)	Power (W/m)	Luminous flux (lm/m)	Angle beam (°)
24	18	1750	34



TT-TRK-SUSP-BALL Page 37

Voltage (vDC)	Power (W/m)	Luminous flux (lm/m)	Angle beam (°)
24	5	290	-



TT-TRK-SUSP-8W Page 38

Voltage (vDC)	Power (W/m)	Luminous flux (lm/m)	Angle beam (°)
24	8	405	24



TT-TRK-SUSP-5W Page 39

Voltage (vDC)	Power (W/m)	Luminous flux (lm/m)	Angle beam (°)
24	5	450	30



TT-TRK-SUSP-10W Page 40

Voltage (vDC)	Power (W/m)	Luminous flux (lm/m)	Angle beam (°)
24	10	780	36





TT-TRK-SUSP-CONE Page 41

Voltage (vDC)	Power (W/m)	Luminous flux (lm/m)	Angle beam (°)
24	10	480	Diffuse



TT-TRK-TRACK-R Page 42

Voltage (vDC)	Power (W/m)	Luminous flux (lm/m)	Angle beam (°)
24	200 max.	-	-



TT-TRK-TRACK-R1/2 Page 43

Voltage (vDC)	Power (W/m)	Luminous flux (lm/m)	Angle beam (°)
24	200 max.	-	-



TT-TRK-TRACK-R1/4 Page 44

Voltage (vDC)	Power (W/m)	Luminous flux (lm/m)	Angle beam (°)
24	200 max.	-	-



TT-TRK-TRACK-R1/8 Page 45

Voltage (vDC)	Power (W/m)	Luminous flux (lm/m)	Angle beam (°)
24	200 max.	-	-



TT-TRK-8W-1R Page 46

Voltage (vDC)	Power (W/m)	Luminous flux (lm/m)	Angle beam (°)
24	8	405	30



TT-TRK-SUSP-10W-R Page 47

Voltage (vDC)	Power (W/m)	Luminous flux (lm/m)	Angle beam (°)
24	10	780	36





TT-TRK-15W-1R Page 48

Voltage (vDC)	Power (W/m)	Luminous flux (lm/m)	Angle beam (°)
24	15	905	30



TT-TRK-6X1R Page 49

Voltage (vDC)	Power (W/m)	Luminous flux (lm/m)	Angle beam (°)
24	8	790	34



TT-TRK-163R Page 50

Voltage (vDC)	Power (W/m)	Luminous flux (lm/m)	Angle beam (°)
24	8	500	Diffuse

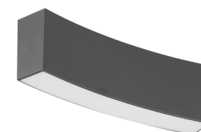

TT-TRK-5W-1R Page 51

Voltage (vDC)	Power (W/m)	Luminous flux (lm/m)	Angle beam (°)
24	5	440	90



TT-TRK-10W-1R Page 52

Voltage (vDC)	Power (W/m)	Luminous flux (lm/m)	Angle beam (°)
24	10	780	24



TT-TRK-BALL-R Page 53

Voltage (vDC)	Power (W/m)	Luminous flux (lm/m)	Angle beam (°)
24	5	290	220



TITANIUM

TECHNOLOGY

TT-TRK-TRACK



Voltage	24vDC	
Size	1000mm x 40mm x 76mm 39 ³ / ₈ " x 1 ¹ / ₂ " x 3"	3000mm x 40mm x 76mm 118 ¹ / ₄ " x 1 ¹ / ₂ " x 3"
Cut hole	40mm 1 ⁹ / ₁₆ "	
Finish	BK - Black W - White WOOD - Wood	
IP	20	

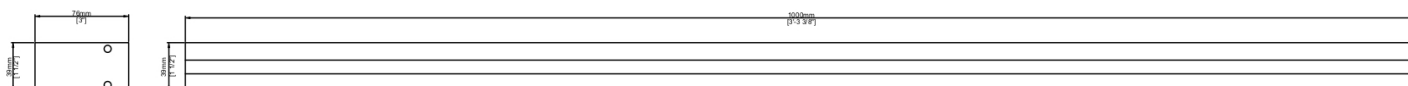

TITANIUM

TECHNOLOGY

TT-TRK-TRACK-PL

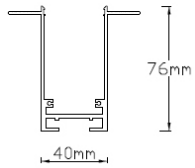
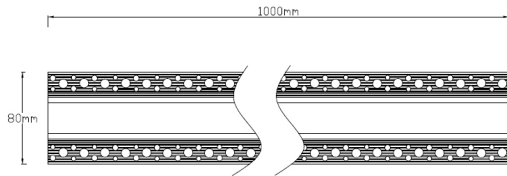
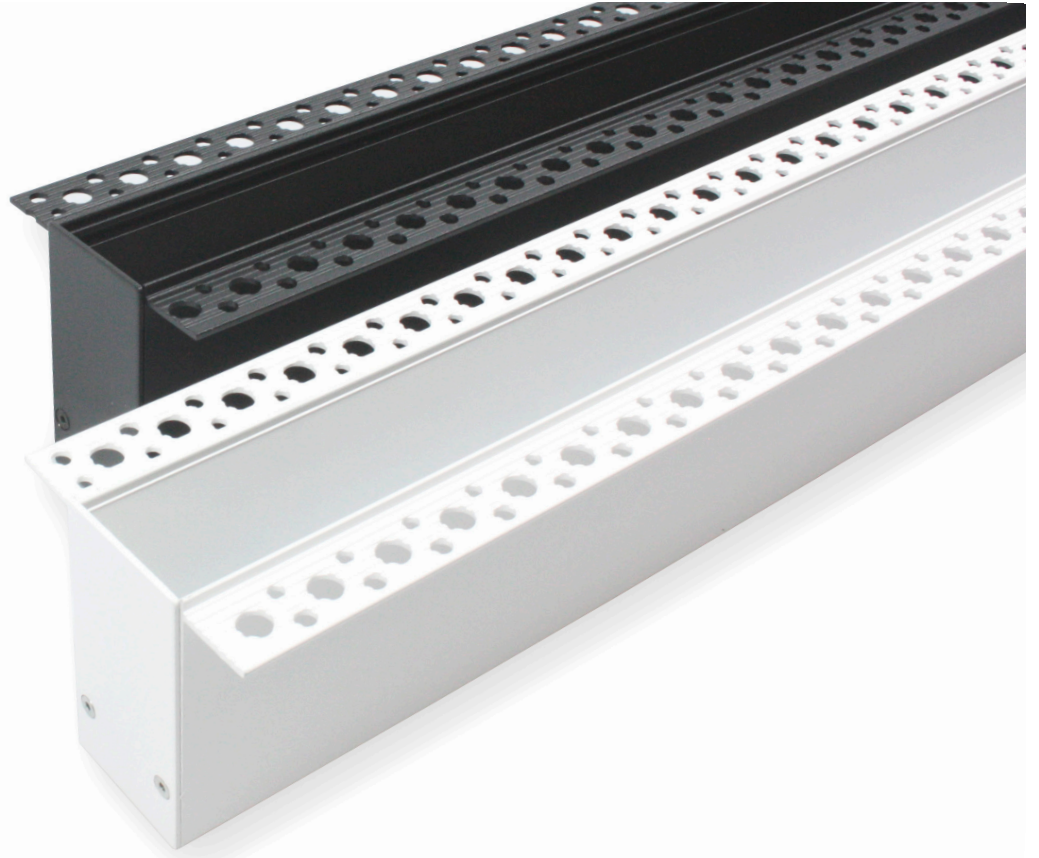

Voltage	24vDC
Size	1000mm x 40mm x 76mm 39 ³ / ₈ " x 1 ⁵ / ₈ " x 3"
Cut hole	40mm 1 ⁵ / ₈ "
Finish	WH - White BK- Black
IP	20

TITANIUM

TECHNOLOGY

TT-TRK-1X1

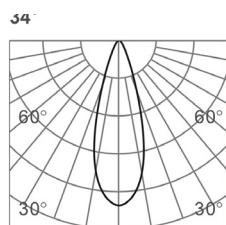
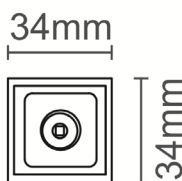
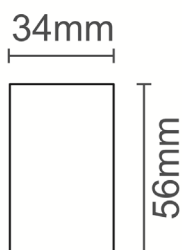
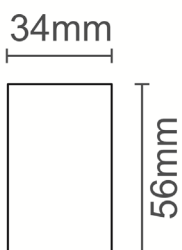

h(m)	E(lx)	Φ(m)
1	429	Φ0.71
2	107	Φ1.43
3	47	Φ2.15
4	26	Φ2.87
5	17	Φ3.59

Voltage 24vDC

Amperage 0,09A

Power LED 2,16W

Lumens 120 lm

CRI 90

Angle 34°

LED Color
 27K - Warm white 2700K
 30K - Warm white 3000K
 40K - Neutral white 4000K

Dimmable Yes

Size 34 x 34 x 56 mm
 1⁵/₁₆" x 1⁵/₁₆" x 2³/₁₆"

Finish
 BK - Black
 WH - White

IP 20

TITANIUM

TECHNOLOGY

TT-TRK-3X1

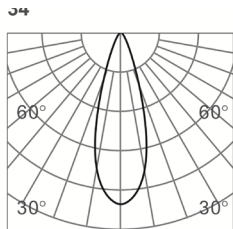
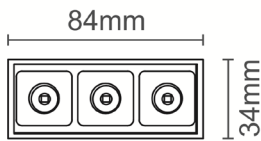
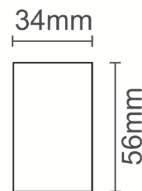
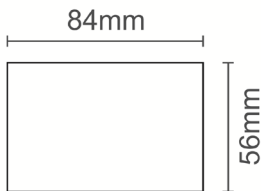

h(m)	E(lx)	Φ(m)
1	1238	Φ0.61
2	309	Φ1.22
3	137	Φ1.83
4	77	Φ2.44
5	49	Φ3.05

Voltage	24vDC
Amperage	0,19A
Power LED	4,56W
Lumens	380 lm
CRI	90
Angle	34°
LED Color	27K - Warm white 2700K 30K - Warm white 3000K 40K - Neutral white 4000K 50K - Cold white 5000K
Dimmable	Yes
Size	84 x 34 x 56 mm 3 1/4" x 1 5/16" x 2 3/16"
Finish	BK - Black WH - White
IP	20

TITANIUM

TECHNOLOGY

TT-TRK-6X1

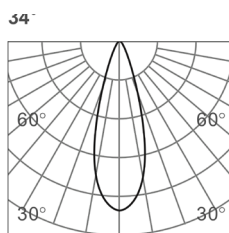
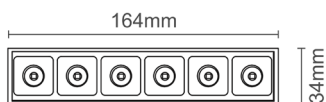
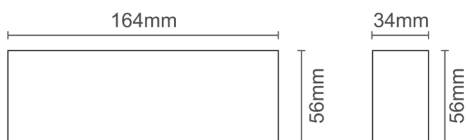

h(m)	E(lx)	Φ(m)
1	2660	Φ0.57
2	664	Φ1.14
3	295	Φ1.72
4	166	Φ2.29
5	106	Φ2.86

Voltage 24vDC

Amperage 0,36A

Power LED 8,64W

Lumens 790 lm

CRI 90

Angle 34°

LED Color
 27K - Warm white 2700K
 30K - Warm white 3000K
 40K - Neutral white 4000K
 50K - Cold white 5000K

Dimmable Yes

Size 164 x 34 x 56 mm
 6⁷/₁₆ x 1⁵/₁₆" x 2³/₁₆"

Finish BK - Black
 WH - White

IP 20

TITANIUM

TECHNOLOGY

TT-TRK-12X1

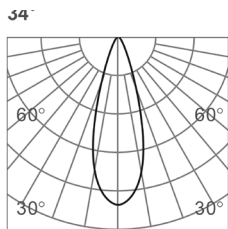
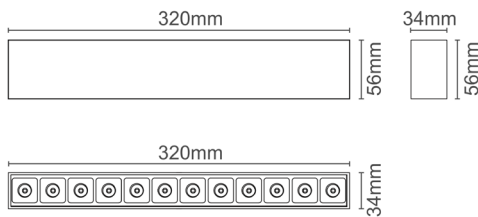

h(m)	E(lx)	Φ(m)
1	5127	Φ0.55
2	1282	Φ1.11
3	569	Φ1.67
4	320	Φ2.23
5	205	Φ2.78

Voltage	24vDC
Amperage	0,72A
Power LED	17,28W
Lumens	1550 lm
CRI	90
Angle	34°
LED Color	27K - Warm white 2700K 30K - Warm white 3000K 40K - Neutral white 4000K 50K - Cold white 5000K
Dimmable	Yes
Size	320 x 34 x 56 mm 12 ¹ / ₂ x 1 ⁵ / ₁₆ " x 2 ³ / ₁₆ "
Finish	BK - Black WH - White
IP	20

TITANIUM

TECHNOLOGY

TT-TRK-3X1D

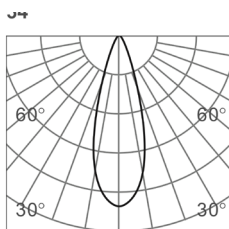
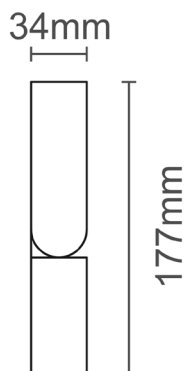
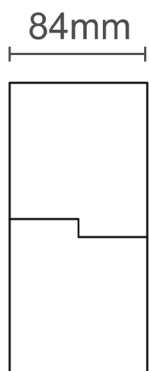

h(m)	E(lx)	Φ(m)
1	1238	Φ0.61
2	309	Φ1.22
3	137	Φ1.83
4	77	Φ2.44
5	49	Φ3.05

Voltage 24vDC

Amperage 0,19A

Power LED 4,56W

Lumens 380 lm

CRI 90

Angle 34°

LED Color
 27K - Warm white 2700K
 30K - Warm white 3000K
 40K - Neutral white 4000K
 50K - Cold white 5000K

Dimmable Yes

Size 84 x 34 x 177 mm
 3¹/₄" x 1⁵/₁₆" x 7"

Finish BK - Black
 WH - White

IP 20

TITANIUM

TECHNOLOGY

TT-TRK-6X1D

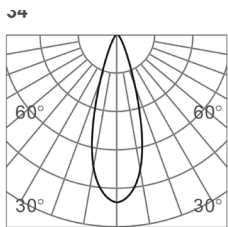
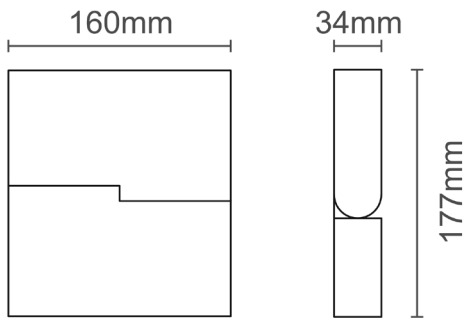

h(m)	E(lx)	Φ(m)
1	2660	Φ0.57
2	664	Φ1.14
3	295	Φ1.72
4	166	Φ2.29
5	106	Φ2.86

Voltage	24vDC
Amperage	0,36A
Power LED	8,64W
Lumens	790 lm
CRI	90
Angle	34°
LED Color	27K - Warm white 2700K 30K - Warm white 3000K 40K - Neutral white 4000K 50K - Cold white 5000K
Dimmable	Yes
Size	160 x 34 x 177 mm 6 1/4" x 1 3/8" x 7"
Finish	BK - Black WH - White
IP	20

TITANIUM

TECHNOLOGY

TT-TRK-12X1D

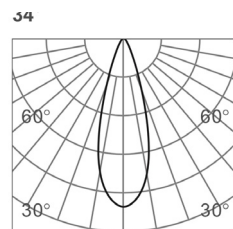
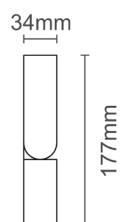
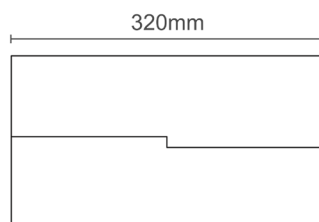

h(m)	E(lx)	Φ(m)
1	5127	Φ0.55
2	1282	Φ1.11
3	569	Φ1.67
4	320	Φ2.23
5	205	Φ2.78

Voltage 24vDC

Amperage 0,72A

Power LED 17,28W

Lumens 1550 lm

CRI 90

Angle 34°

LED Color
 27K - Warm white 2700K
 30K - Warm white 3000K
 40K - Neutral white 4000K
 50K - Cold white 5000K

Dimmable Yes

Size 320 x 34 x 177 mm
 12½" x 1⅝" x 7"

Finish BK - Black
 WH - White

IP 20

TITANIUM

TECHNOLOGY

TT-TRK-322

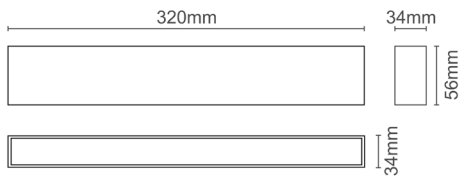

Diffuse

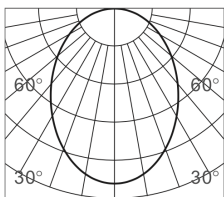

h(m)	E(lx)	Φ(m)
1	426	Φ2.51
2	106	Φ5.02
3	47	Φ7.53
4	26	Φ10.04
5	17	Φ12.55

Voltage	24vDC
Amperage	0,7A
Power LED	16,8W
Lumens	980 lm
CRI	90
Angle	120°
LED Color	27K - Warm white 2700K 30K - Warm white 3000K 40K - Neutral white 4000K 50K - Cold white 5000K
Dimmable	Yes
Size	320 x 34 x 56 mm 12 ⁵ / ₈ " x 1 ⁵ / ₁₆ " x 2 ³ / ₁₆ "
Finish	BK - Black WH - White
IP	20

TITANIUM

TECHNOLOGY

TT-TRK-640

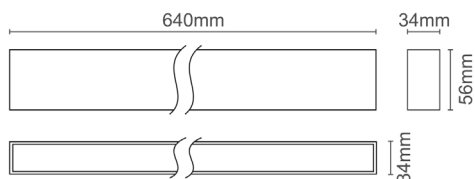

Voltage 24vDC

Amperage 1,08A

Power LED 26W

Lumens 1900 lm

CRI 90

Angle 120°

LED Color
 27K - Warm white 2700K
 30K - Warm white 3000K
 40K - Neutral white 4000K
 50K - Cold white 5000K

Dimmable Yes

Size
 640 x 34 x 56 mm
 25¹/₄" x 1⁵/₁₆" x 2³/₁₆"

Finish
 BK - Black
 WH - White

IP 20

Diffuse

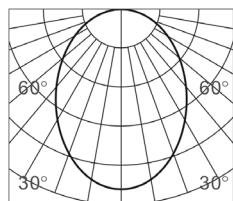

h(m)	E(lx)	Φ(m)
1	479	Φ2.65
2	119	Φ5.30
3	53	Φ7.95
4	29	Φ10.60
5	19	Φ13.25

TITANIUM

TECHNOLOGY

TT-TRK-958

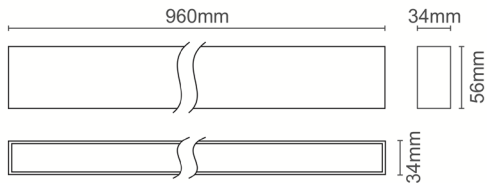
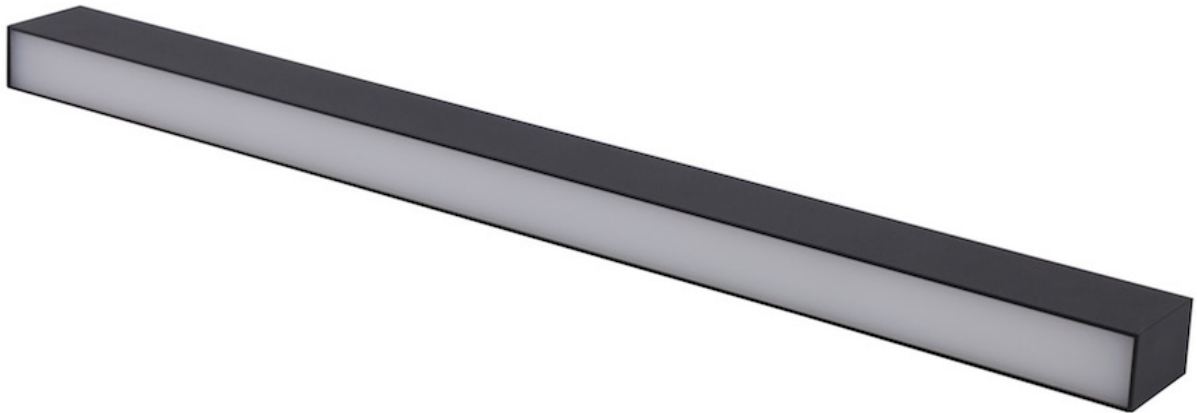

Diffuse

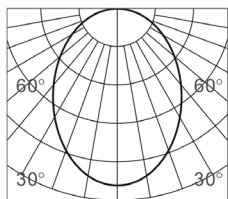

h(m)	E(lx)	Φ(m)
1	889	Φ2.23
2	222	Φ4.46
3	98	Φ6.69
4	55	Φ8.92
5	35	Φ11.15

Voltage 24vDC

Amperage 1,625A

Power LED 39W

Lumens 2850 lm

CRI 90

Angle 120°

LED Color
 27K - Warm white 2700K
 30K - Warm white 3000K
 40K - Neutral white 4000K
 50K - Cold white 5000K

Dimmable Yes

Size
 960 x 34 x 56 mm
 37⁵/₈" x 1⁵/₁₆" x 2³/₁₆"

Finish
 BK - Black
 WH - White

IP 20

TITANIUM

TECHNOLOGY

TT-TRK-84D

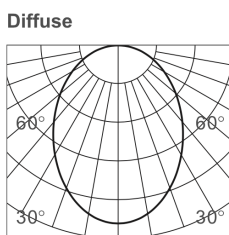
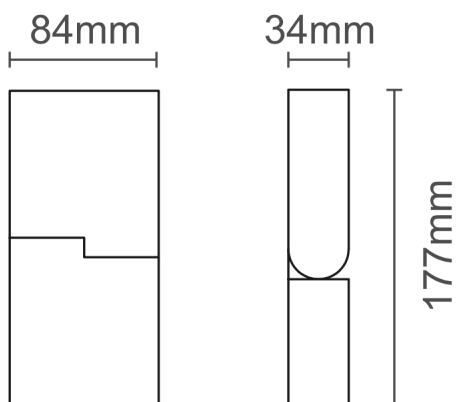

h(m)	E(lx)	Φ(m)
1	105.5	Φ2.60
2	26.3	Φ5.20
3	11.7	Φ7.80
4	6.5	Φ10.40
5	4.2	Φ13.00

Voltage	24vDC
Amperage	0,18A
Power LED	4,32W
Lumens	280 lm
CRI	90
Angle	120°
LED Color	27K - Warm white 2700K 30K - Warm white 3000K 40K - Neutral white 4000K 50K - Cold white 5000K
Dimmable	Yes
Size	84 x 34 x 177 mm 3 ¹ / ₄ " x 1 ⁵ / ₁₆ " x 6 ¹⁵ / ₁₆ "
Finish	BK - Black WH - White
IP	20

TITANIUM

TECHNOLOGY

TT-TRK-164D

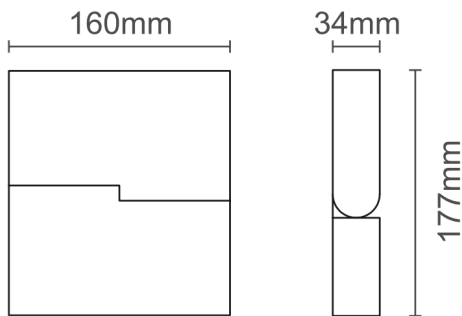

Diffuse

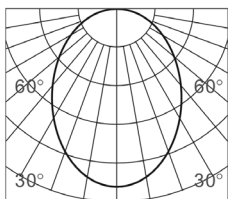

h(m)	E(lx)	Φ(m)
1	236	Φ2.59
2	59	Φ5.19
3	26	Φ7.79
4	14	Φ10.39
5	9	Φ12.99

Voltage	24vDC
Amperage	0,36A
Power LED	8,64W
Lumens	500 lm
CRI	90
Angle	120°
LED Color	27K - Warm white 2700K 30K - Warm white 3000K 40K - Neutral white 4000K 50K - Cold white 5000K
Dimmable	Yes
Size	160 x 34 x 177 mm 6 ⁵ / ₁₆ " x 1 ⁵ / ₁₆ " x 6 ¹⁵ / ₁₆ "
Finish	BK - Black WH - White
IP	20

TITANIUM

TECHNOLOGY

TT-TRK-323D

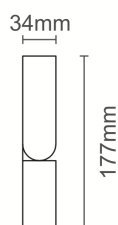
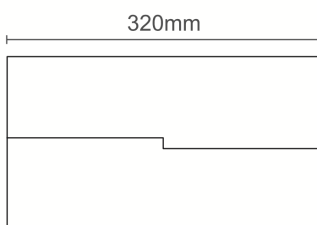

Diffuse

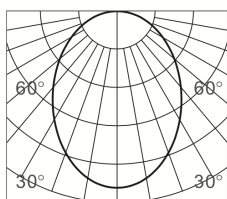

h(m)	E(lx)	Φ(m)
1	234	Φ2.47
2	58	Φ4.95
3	26	Φ7.43
4	14	Φ9.90
5	9	Φ12.38

Voltage	24vDC
Amperage	0,7A
Power LED	16,8W
Lumens	980 lm
CRI	90
Angle	120°
LED Color	27K - Warm white 2700K 30K - Warm white 3000K 40K - Neutral white 4000K 50K - Cold white 5000K
Dimmable	Yes
Size	320 x 34 x 177 mm 12 ⁵ / ₈ " x 1 ⁵ / ₁₆ " x 6 ¹⁵ / ₁₆ "
Finish	BK - Black WH - White
IP	20

TITANIUM

TECHNOLOGY

TT-TRK-BALL

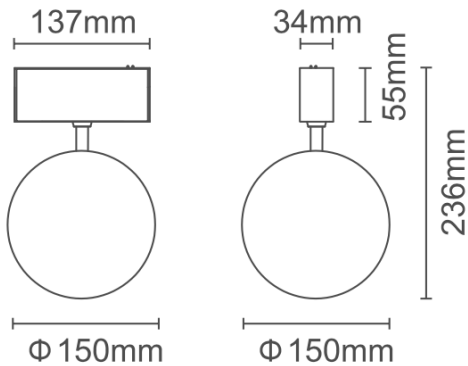

Diffuse

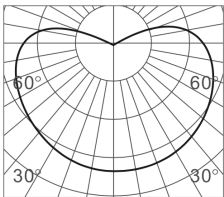

h(m)	E(lx)	Φ(m)
1	24	Φ2
2	6	Φ4
3	2	Φ6
4	1	Φ8
5	0.9	Φ10

Voltage	24vDC
Amperage	0,30A
Power LED	7,2W
Lumens	290 lm
CRI	90
Angle	360°
LED Color	27K - Warm white 2700K 30K - Warm white 3000K 40K - Neutral white 4000K 50K - Cold white 5000K
Dimmable	Yes
Size	137 x 34 x 55 mm Ø140mm 5 ³ / ₈ " x 1 ⁵ / ₁₆ " x 2 ³ / ₁₆ " Ø5 ¹ / ₂ "
Finish	BK - Black WH - White
IP	20

TITANIUM

TECHNOLOGY

TT-TRK-15

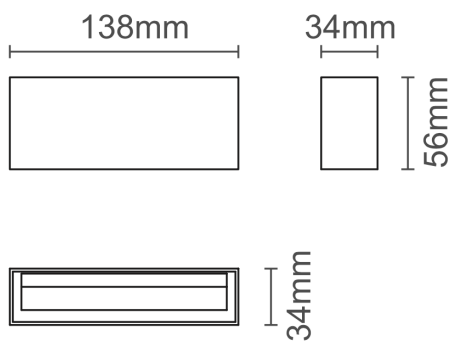

Voltage 24vDC

Amperage 0,29A

Power LED 6,96W

Lumens 380 lm

CRI 90

Angle 120°

LED Color
 27K - Warm white 2700K
 30K - Warm white 3000K
 40K - Neutral white 4000K
 50K - Cold white 5000K

Dimmable Yes

Size
 138 x 34 x 56 mm
 5⁷/₁₆" x 1⁵/₁₆" x 2³/₁₆"

Finish
 BK - Black
 WH - White

IP 20

Wallwasher

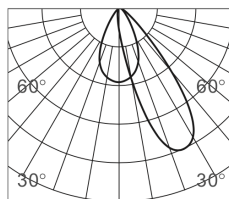

h(m)	E(lx)	Φ(m)
1	137	Φ0.97
2	34	Φ1.94
3	15	Φ2.91
4	8	Φ3.88
5	5	Φ4.85

TITANIUM

TECHNOLOGY

TT-TRK-30

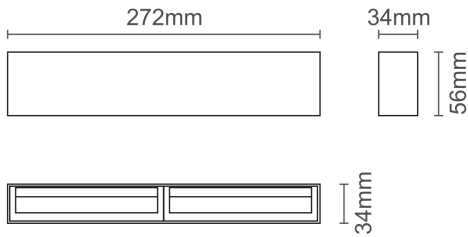

Voltage	24vDC
Amperage	0,58A
Power LED	13,92W
Lumens	880 lm
CRI	90
Angle	120°
LED Color	27K - Warm white 2700K 30K - Warm white 3000K 40K - Neutral white 4000K 50K - Cold white 5000K
Dimmable	Yes
Size	272 x 34 x 56 mm 10 ¹¹ / ₁₆ " x 1 ⁵ / ₁₆ " x 2 ³ / ₁₆ "
Finish	BK - Black WH - White
IP	20

Wallwasher

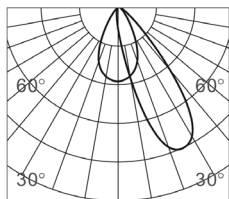

h(m)	E(lx)	Φ(m)
1	344	Φ0.90
2	86	Φ1.80
3	38	Φ2.70
4	21	Φ3.59
5	13	Φ4.49

TITANIUM

TECHNOLOGY

TT-TRK-5W-1

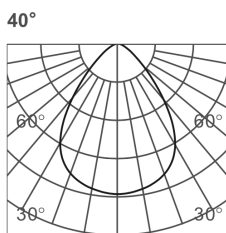
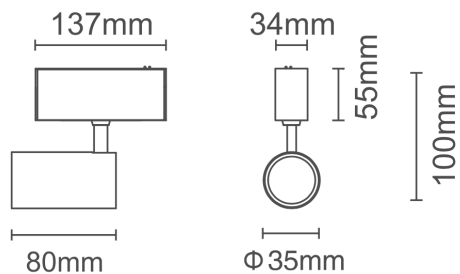

h(m)	E(lx)	Φ(m)
2	278	Φ0.96
3	124	Φ1.44
3.5	91	Φ1.68
4	69	Φ1.92
5	44	Φ2.40

Voltage 24vDC

Amperage 0,24A

Power LED 5,76W

Lumens 440 lm

CRI 90

Angle 40°

LED Color
 27K - Warm white 2700K
 30K - Warm white 3000K
 40K - Neutral white 4000K
 50K - Cold white 5000K

Dimmable Yes

Size
 Ø35 x 80 mm
 Ø1³/₈" x 3¹/₈"

Finish
 BK - Black
 WH - White

IP 20

TITANIUM

TECHNOLOGY

TT-TRK-5W-2

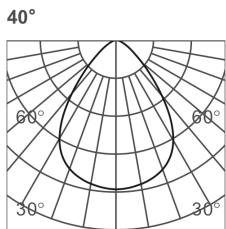
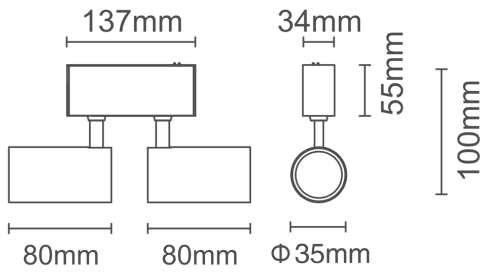

h(m)	E(lx)	Φ(m)
2	278	Φ0.96
3	124	Φ1.44
3.5	91	Φ1.68
4	69	Φ1.92
5	44	Φ2.40

Voltage	24vDC
Amperage	0,48A
Power LED	11,52W
Lumens	880 lm
CRI	90
Angle	40°
LED Color	27K - Warm white 2700K 30K - Warm white 3000K 40K - Neutral white 4000K 50K - Cold white 5000K
Dimmable	Yes
Size	2 x Ø35 x 80 mm 2 x Ø1 ³ / ₈ " x 3 ¹ / ₈ "
Finish	BK - Black WH - White
IP	20

TITANIUM

TECHNOLOGY

TT-TRK-8W-1

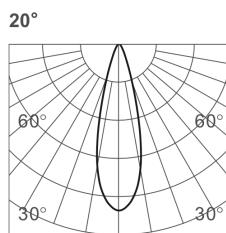
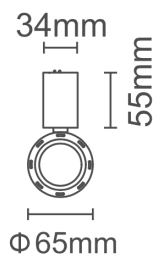
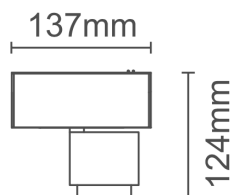

h(m)	E(lx)	Φ(m)
1	2675	Φ0.26
2	668	Φ0.53
3	297	Φ0.80
4	167	Φ1.06
5	107	Φ1.33

Voltage 24vDC

Amperage 0,36A

Power LED 8,64W

Lumens 405 lm

CRI 90

Angle 20°

LED Color
 27K - Warm white 2700K
 30K - Warm white 3000K
 40K - Neutral white 4000K
 50K - Cold white 5000K

Dimmable Yes

Size
 Ø65 mm
 Ø2 1/2"

Finish
 BK - Black
 WH - White

IP 20

TITANIUM

TECHNOLOGY

TT-TRK-10W-1

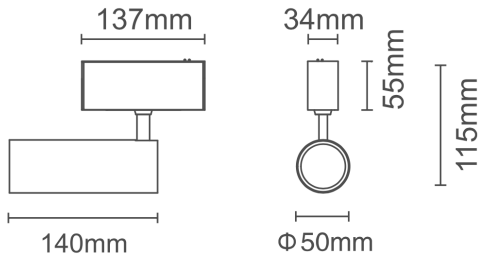

24°

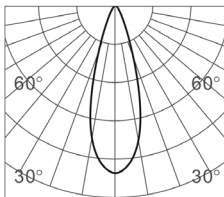

h(m)	E(lx)	Φ(m)
1	3857	Φ0.40
2	964	Φ0.81
3	428	Φ1.22
4	241	Φ1.62
5	154	Φ2.03

Voltage 24vDC

Amperage 0,44A

Power LED 10,56W

Lumens 780 lm

CRI 90

Angle 24°

LED Color
 27K - Warm white 2700K
 30K - Warm white 3000K
 40K - Neutral white 4000K
 50K - Cold white 5000K

Dimmable Yes

Size
 Ø50 x 140 mm
 Ø2" x 5 1/2"

Finish
 BK - Black
 WH - White

IP 20

TITANIUM

TECHNOLOGY

TT-TRK-15W-1

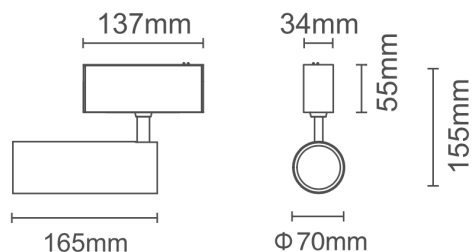

Voltage 24vDC

Amperage 0,68A

Power LED 16,32W

Lumens 905 lm

CRI 90

Angle 20°

LED Color
 27K - Warm white 2700K
 30K - Warm white 3000K
 40K - Neutral white 4000K
 50K - Cold white 5000K

Dimmable Yes

Size
 Ø92 mm
 Ø3⁵/₈"

Finish
 BK - Black
 WH - White

IP 20

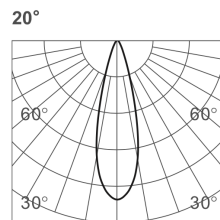

h(m)	E lx	Φ(m)
1	4847	Φ0.30
2	1212	Φ0.60
3	538	Φ0.90
4	302	Φ1.20
5	193	Φ1.51

TITANIUM

TECHNOLOGY

TT-TRK-20W-1

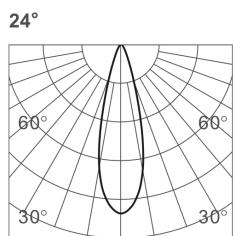
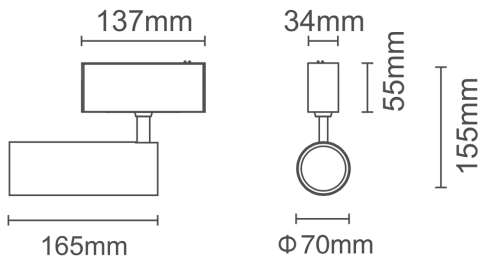

h(m)	E(lx)	Φ(m)
1	5787	Φ0,47
2	1447	Φ0,95
3	643	Φ1,42
4	361	Φ1,90
5	231	Φ2,37

Voltage 24vDC

Amperage 0,9A

Power LED 21,6W

Lumens 1450 lm

CRI 90

Angle 24°

LED Color
 27K - Warm white 2700K
 30K - Warm white 3000K
 40K - Neutral white 4000K
 50K - Cold white 5000K

Dimmable Yes

Size
 Ø70 x 165 mm
 Ø2³/₄" x 6¹/₂"

Finish
 BK - Black
 WH - White

IP 20

TITANIUM

TECHNOLOGY

TT-TRK-10W-1Z

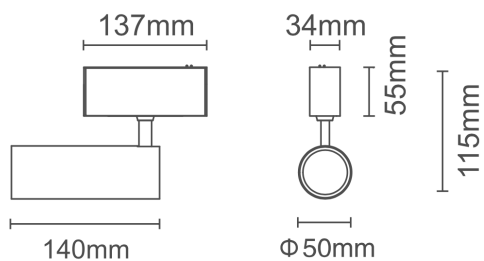

Voltage 24vDC

Amperage 0,43A

Power LED 10,32W

Lumens 780 lm

CRI 90

Angle 10° to 50°

LED Color
27K - Warm white 2700K
30K - Warm white 3000K
40K - Neutral white 4000K
50K - Cold white 5000K

Dimmable Yes

Size
Ø50 x 140 mm
Ø2" x 5½"

Finish
BK - Black
WH - White

IP 20

TITANIUM

TECHNOLOGY

TT-TRK-120C

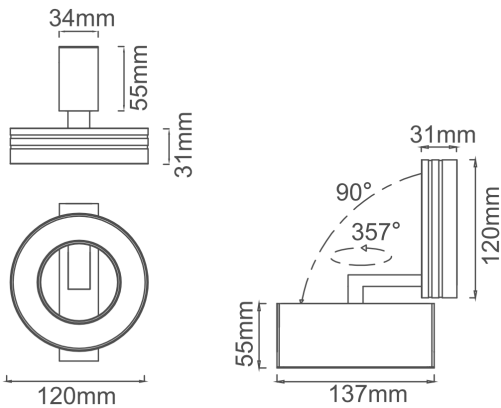
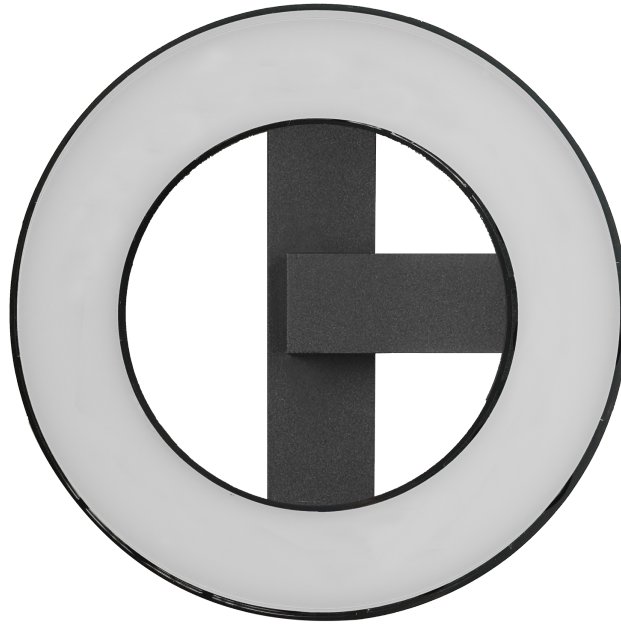

Voltage	24vDC
Amperage	0,5A
Power LED	12W
Lumens	650 lm
CRI	90
Angle	Diffuse
LED Color	27K - Warm white 2700K 30K - Warm white 3000K 40K - Neutral white 4000K 50K - Cold white 5000K
Dimmable	Yes
Size	137 mm x 34 mm x 56 mm x Ø120 mm 5 ³ / ₈ " x 1 ³ / ₈ " x 2 ³ / ₁₆ " x Ø4 ³ / ₄ "
Finish	BK - Black WH - White
IP	20

TITANIUM

TECHNOLOGY

TT-TRK-164C

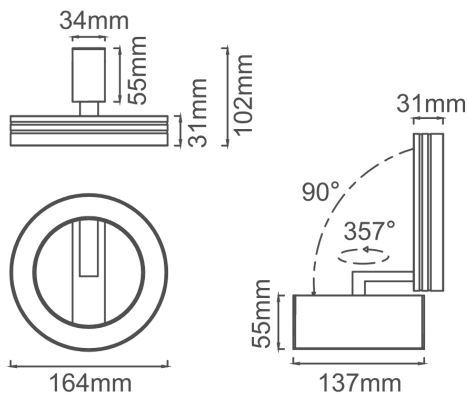

Voltage 24vDC

Amperage 0,75A

Power LED 18W

Lumens 650 lm

CRI 90

Angle Diffuse

LED Color
 27K - Warm white 2700K
 30K - Warm white 3000K
 40K - Neutral white 4000K
 50K - Cold white 5000K

Dimmable Yes

Size 137 mm x 34 mm x 55 mm x Ø164 mm
 $5\frac{3}{8}'' \times 1\frac{3}{8}'' \times 2\frac{3}{16}'' \times \text{Ø}6\frac{7}{16}''$

Finish
 BK - Black
 WH - White

IP 20

TITANIUM

TECHNOLOGY

TT-TRK-12X1W-C

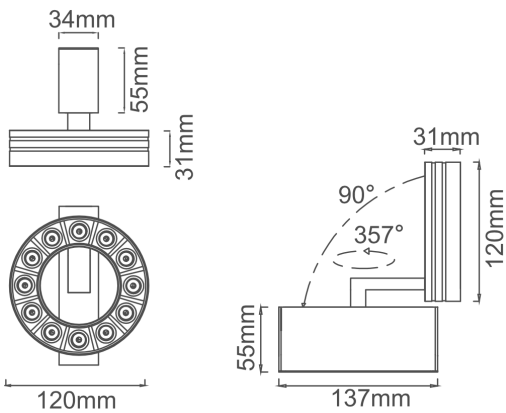
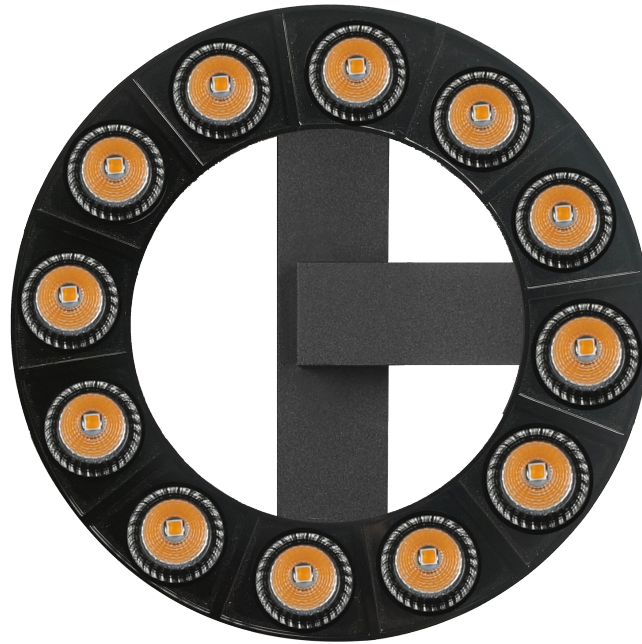

Voltage	24vDC
Amperage	0,52A
Power LED	12,48W
Lumens	1150 lm
CRI	90
Angle	34°
LED Color	27K - Warm white 2700K 30K - Warm white 3000K 40K - Neutral white 4000K 50K - Cold white 5000K
Dimmable	Yes
Size	137 mm x 34 mm x 55 mm x Ø120 mm 5 ³ / ₈ " x 1 ³ / ₈ " x 2 ³ / ₁₆ " x Ø4 ³ / ₄ "
Finish	BK - Black WH - White
IP	20

TITANIUM

TECHNOLOGY

TT-TRK-18X1W-C

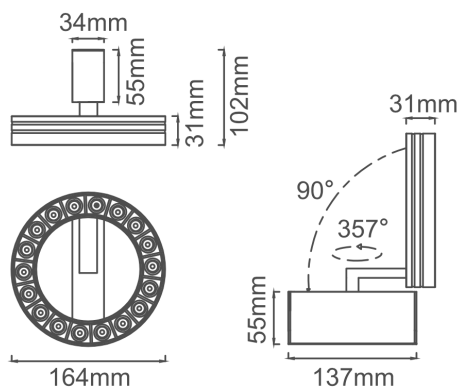

Voltage 24vDC

Amperage 0,75A

Power LED 18W

Lumens 1750 lm

CRI 90

Angle 34°

LED Color
27K - Warm white 2700K
30K - Warm white 3000K
40K - Neutral white 4000K
50K - Cold white 5000K

Dimmable Yes

Size 137 mm x 34 mm x 55 mm x Ø164 mm
5³/₈" x 1³/₈" x 2³/₁₆" x Ø6⁷/₁₆"

Finish
BK - Black
WH - White

IP 20

TITANIUM

TECHNOLOGY

TT-TRK-SUSP-BALL

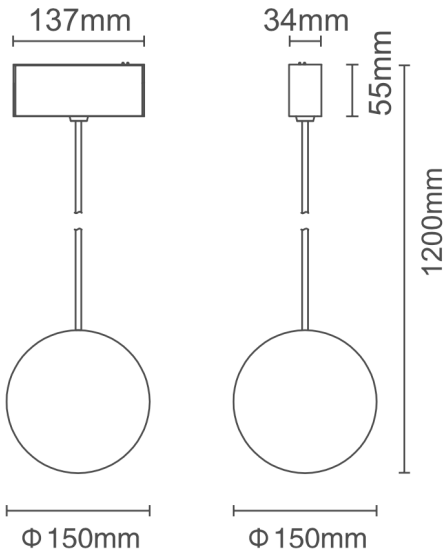

Voltage	24vDC
Amperage	0,30A
Power LED	7,2W
Lumens	290 lm
CRI	90
LED Color	27K - Warm white 2700K 30K - Warm white 3000K 40K - Neutral white 4000K 50K - Cold white 5000K
Dimmable	Yes
Size	137 x 34 x 55 mm Ø1200mm 5 ³ / ₈ " x 1 ⁵ / ₁₆ " x 2 ³ / ₁₆ " x Ø47 ¹ / ₄ "
Finish	BK - Black WH - White
IP	20

Diffuse

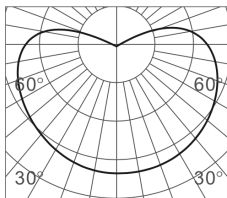

h(m)	E(lx)	Φ(m)
1	24	Φ2
2	6	Φ4
3	2	Φ6
4	1	Φ8
5	0.9	Φ10

TITANIUM

TECHNOLOGY

TT-TRK-SUSP-8W

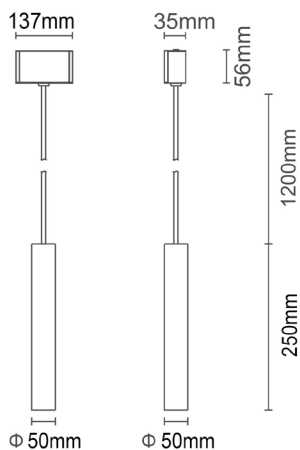

Voltage 24vDC

Amperage 0,33A

Power LED 8W

Lumens 405 lm

CRI 90

Angle 24°

LED Color
27K - Warm white 2700K
30K - Warm white 3000K
40K - Neutral white 4000K
50K - Cold white 5000K

Dimmable Yes

Size
Ø50 x 250 mm
Ø2" x 9⁷/₈"

Finish
BK - Black
WH - White

IP 20

TITANIUM

TECHNOLOGY

TT-TRK-SUSP-5W

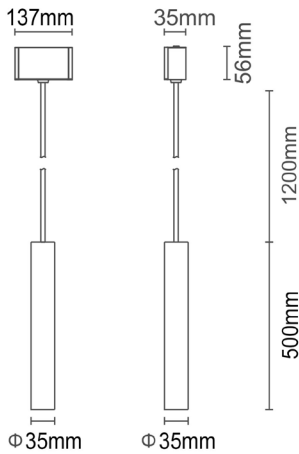

30°

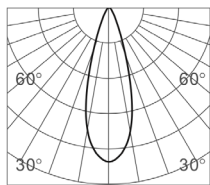

h(m)	E(k)	Φ(m)
1	2519	Φ0.32
2	629	Φ0.65
3	279	Φ0.98
4	157	Φ1.31
5	100	Φ1.64

Voltage	24vDC
Amperage	0,29A
Power LED	6,96W
Lumens	450 lm
CRI	90
Angle	30°
LED Color	27K - Warm white 2700K 30K - Warm white 3000K 40K - Neutral white 4000K 50K - Cold white 5000K
Dimmable	Yes
Size	Ø35 mm x 500mm Ø3 ⁵ / ₈ " x 19 ¹¹ / ₁₆ "
Finish	BK - Black WH - White
IP	44

TITANIUM

TECHNOLOGY

TT-TRK-SUSP-10W

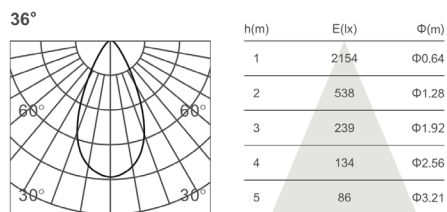
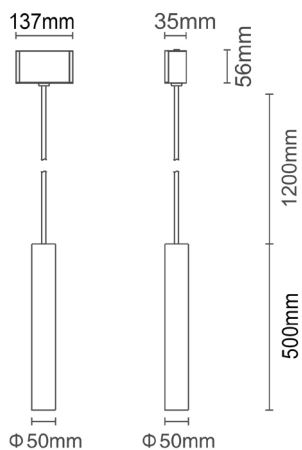

Voltage 24vDC

Amperage 0,46A

Power LED 11,04W

Lumens 780 lm

CRI 90

Angle 36°

LED Color
 27K - Warm white 2700K
 30K - Warm white 3000K
 40K - Neutral white 4000K
 50K - Cold white 5000K

Dimmable Yes

Size
 Ø50 x 500 mm
 Ø2" x 19¹¹/₁₆"

Finish
 BK - Black
 WH - White

IP 20

TITANIUM

TECHNOLOGY

TT-TRK-SUSP-CONE

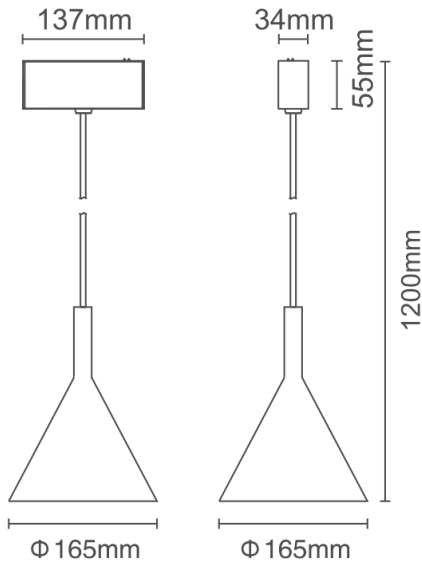

Diffuse

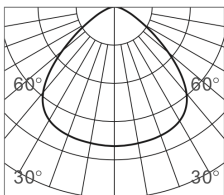

h(m)	E(x)	Φ(m)
1	500	Φ1.20
2	125	Φ2.40
3	55.6	Φ3.60
4	31.2	Φ4.80
5	20	Φ6.00

Voltage	24vDC
Amperage	0,43A
Power LED	10,32W
Lumens	480 lm
CRI	90
Angle	Diffuse
LED Color	27K - Warm white 2700K 30K - Warm white 3000K 40K - Neutral white 4000K 50K - Cold white 5000K
Dimmable	Yes
Size	137 x 34 x 55 x 1200mm 5 ³ / ₈ " x 1 ⁵ / ₁₆ " x 2 ³ / ₁₆ " x 47 ¹ / ₄ "
Finish	BK - Black WH - White
IP	20

TITANIUM

TECHNOLOGY

TT-TRK-TRACK-R

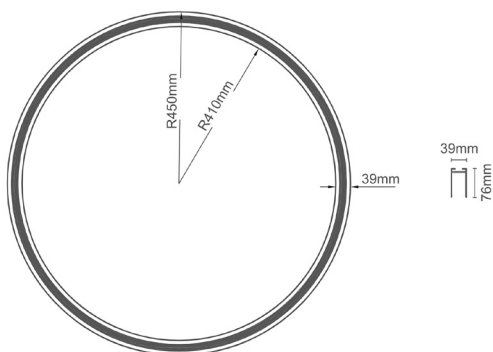

Voltage	24vDC
Size	900mm x 39mm x 76mm 35 ³ / ₈ " x 1 ¹ / ₂ " x 3"
Power	200w max.
Finish	BK - Black W - White
IP	20

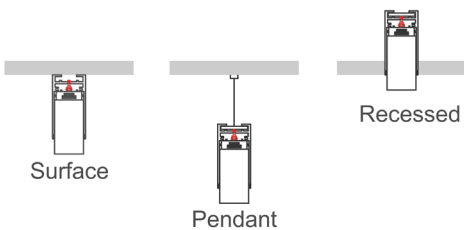

Accessories

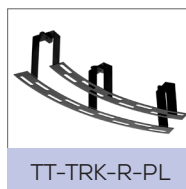

TITANIUM

TECHNOLOGY

TT-TRK-TRACK-R1/2

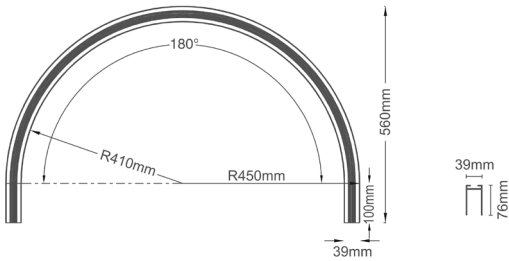

Voltage	24vDC
Size	906mm x 39mm x 76mm 35 ⁵ / ₈ " x 1 ¹ / ₂ " x 3"
Power	200w max.
Cut hole	40mm 1 ⁹ / ₁₆ "
Finish	BK - Black W - White
IP	20

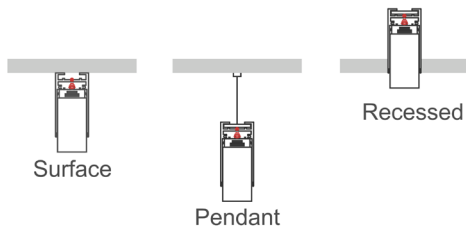

Accessories



TITANIUM

TECHNOLOGY

TT-TRK-TRACK-R1/4

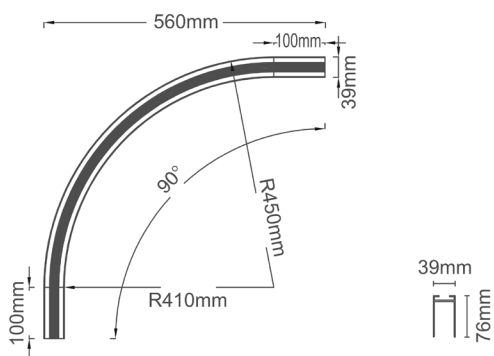

Voltage	24vDC
Size	560mm x 39mm x 76mm 22" x 1 1/2" x 3"
Power	200w max.
Finish	BK - Black W - White
IP	20

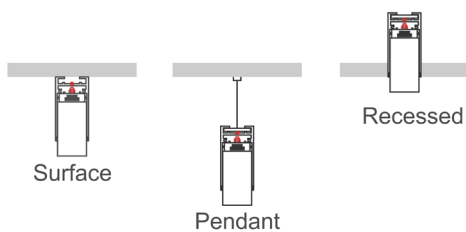

Accessories



TT-TRACK-SUSP

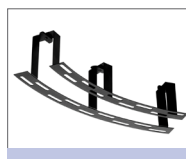

TT-TRK-R-PL

TITANIUM

TECHNOLOGY

TT-TRK-TRACK-R1/8

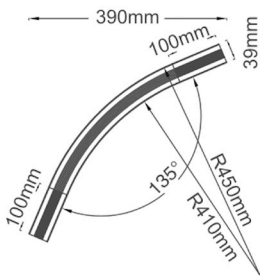

Voltage	24vDC
Size	390mm x 39mm x 76mm 15 ³ / ₈ " x 1 ¹ / ₂ " x 3"
Power	200w max.
Finish	BK - Black W - White
IP	20

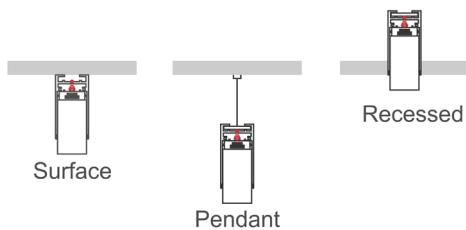

Accessories



TT-TRACK-SUSP

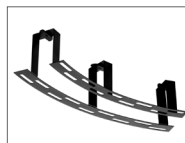

TT-TRK-R-PL

TITANIUM

TECHNOLOGY

TT-TRK-8W-1R

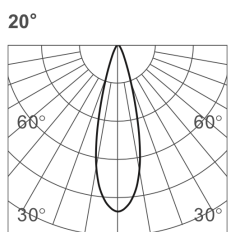
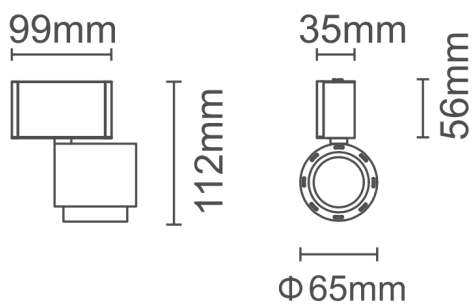

h(m)	E(lx)	Φ(m)
1	2675	Φ0.26
2	668	Φ0.53
3	297	Φ0.80
4	167	Φ1.06
5	107	Φ1.33

Voltage 24vDC

Amperage 0,36A

Power LED 8,64W

Lumens 405 lm

CRI 90

Angle 30°

LED Color
27K - Warm white 2700K
30K - Warm white 3000K
40K - Neutral white 4000K

Size
 137 x 125 x 34 mm
 5³/₈" x 4⁷/₈" x 1³/₈"

Finish
 BK - Black
 WH - White

IP 20

TITANIUM

TECHNOLOGY

TT-TRK-SUSP-10W-R

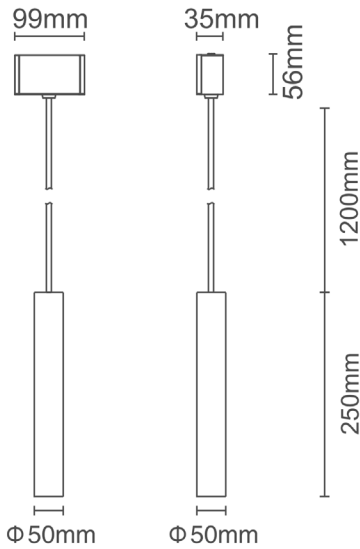

Voltage	24vDC
Amperage	0,46A
Power LED	11,04W
Lumens	780 lm
CRI	90
Angle	36°
LED Color	27K - Warm white 2700K 30K - Warm white 3000K 40K - Neutral white 4000K
Size	99 x 38 x 1450 mm 3 ⁷ / ₈ " x 1 ³ / ₈ " x 57 ¹ / ₈ "
Finish	BK - Black WH - White
IP	20

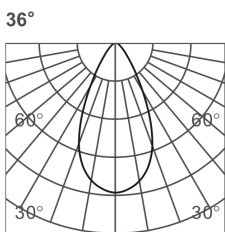

h(m)	E(lx)	Φ(m)
1	2154	Φ0.64
2	538	Φ1.28
3	239	Φ1.92
4	134	Φ2.56
5	86	Φ3.21

TITANIUM

TECHNOLOGY

TT-TRK-15W-1R

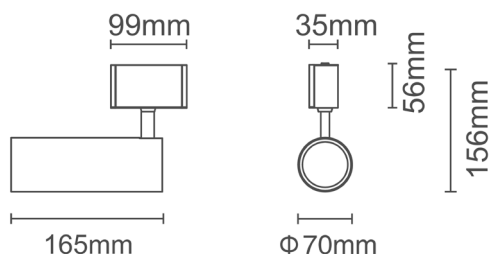

Voltage	24vDC
Amperage	0,68A
Power LED	16,32W
Lumens	905 lm
CRI	90
Angle	30°
LED Color	27K - Warm white 2700K 30K - Warm white 3000K 40K - Neutral white 4000K
Size	99 x 35 x 156 mm 3 ⁷ / ₈ " x 1 ³ / ₈ " x 6 ¹ / ₈ "
Finish	BK - Black WH - White
IP	20

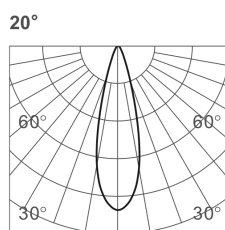

h(m)	E(lx)	Φ(m)
1	4847	Φ0.30
2	1212	Φ0.60
3	538	Φ0.90
4	302	Φ1.20
5	193	Φ1.51

TITANIUM

TECHNOLOGY

TT-TRK-6X1R

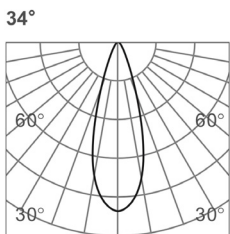
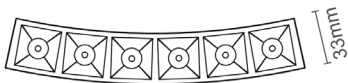
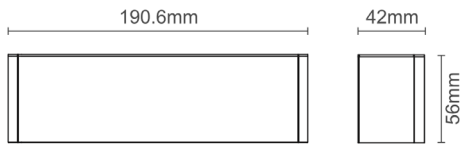
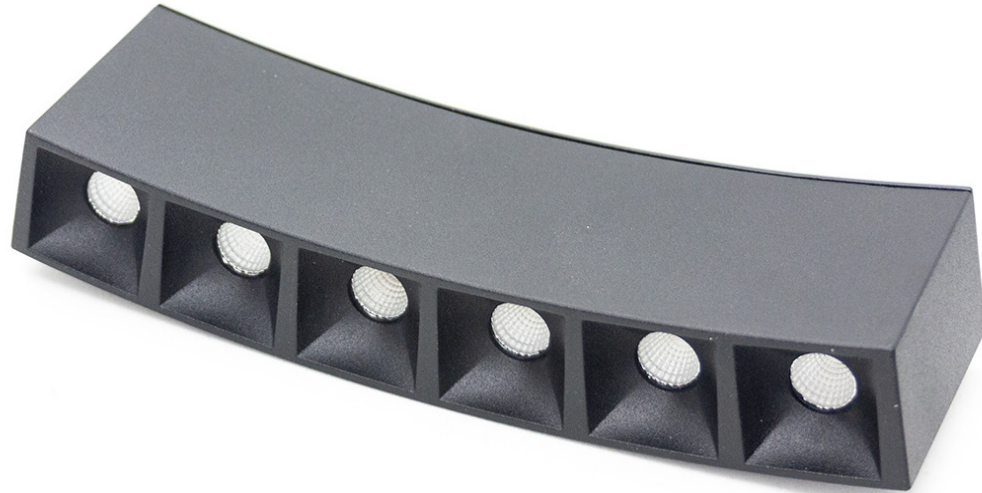

h(m)	E(lx)	Φ(m)
1	2800	Φ 0.53
2	700	Φ 1.07
3	311	Φ 1.60
4	175	Φ 2.14
5	112	Φ 2.67

Voltage	24vDC
Amperage	0,36A
Power LED	8,64W
Lumens	790 lm
CRI	90
Angle	34°
LED Color	27K - Warm white 2700K 30K - Warm white 3000K 40K - Neutral white 4000K
Dimmable	Yes
Size	190 mm x 42 mm x 56 mm 7 ¹ / ₂ " x 1 ⁵ / ₁₆ " x 2 ³ / ₁₆ "
Finish	BK - Black WH - White
IP	20

TITANIUM

TECHNOLOGY

TT-TRK-163R

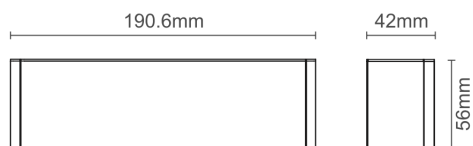

Diffuse

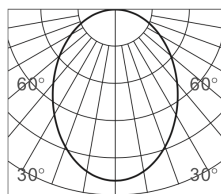

h(m)	E(lx)	Φ(m)
1	119	Φ2.56
2	29	Φ5.12
3	13	Φ7.68
4	7	Φ10.24
5	4	Φ12.81

Voltage 24vDC

Amperage 0,36A

Power LED 8,64W

Lumens 500 lm

CRI 90

Angle Diffuse

LED Color
27K - Warm white 2700K
30K - Warm white 3000K
40K - Neutral white 4000K

Dimmable Yes

Size 190 mm x 42 mm x 56 mm
 7¹/₂" x 1⁵/₁₆" x 2³/₁₆"

Finish
BK - Black
WH - White

IP 20

TITANIUM

TECHNOLOGY

TT-TRK-5W-1R

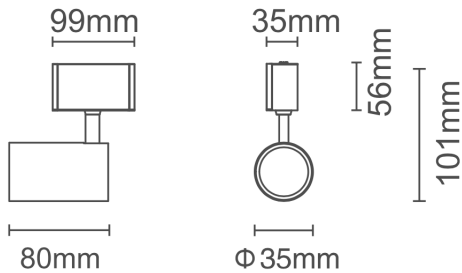

Voltage	24vDC
Amperage	0,24A
Power LED	5,76W
Lumens	440 lm
CRI	90
LED Color	27K - Warm white 2700K 30K - Warm white 3000K 40K - Neutral white 4000K
Dimmable	Yes
Size	99 mm x 35 mm x 101 3 ⁷ / ₈ " x 1 ³ / ₈ " x 4"
Finish	BK - Black WH - White
IP	20

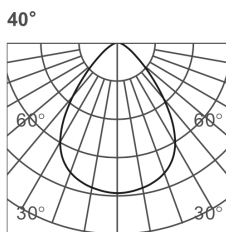

h(m)	E(lx)	Φ(m)
2	278	Φ0.96
3	124	Φ1.44
3.5	91	Φ1.68
4	69	Φ1.92
5	44	Φ2.40

TITANIUM

TECHNOLOGY

TT-TRK-10W-1R

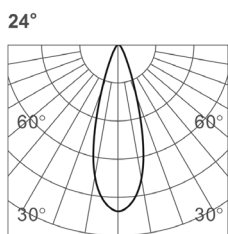
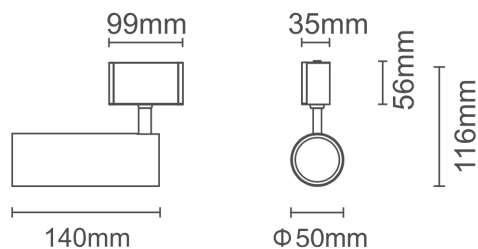

h(m)	E(lx)	Φ(m)
1	3857	Φ0.40
2	964	Φ0.81
3	428	Φ1.22
4	241	Φ1.62
5	154	Φ2.03

Voltage 24vDC

Amperage 0,44A

Power LED 10,56W

Lumens 780 lm

CRI 90

Angle 24°

LED Color
 27K - Warm white 2700K
 30K - Warm white 3000K
 40K - Neutral white 4000K

Dimmable Yes

Size 99 mm x 35 mm x 116
 3⁷/₈" x 1³/₈" x 3⁹/₁₆"

Finish
 BK - Black
 WH - White

IP 20

TITANIUM

TECHNOLOGY

TT-TRK-BALL-R

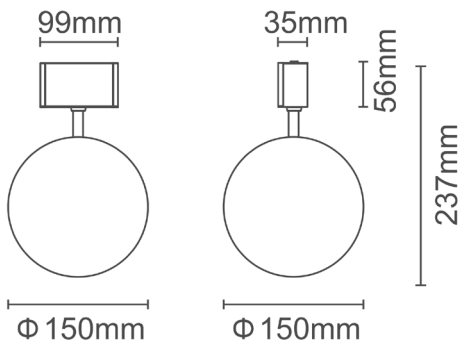

Voltage	24vDC
Amperage	0,30A
Power LED	7,2W
Lumens	290 lm
CRI	90
Angle	220°
LED Color	27K - Warm white 2700K 30K - Warm white 3000K 40K - Neutral white 4000K
Size	99 x 35 x 237 mm 3 ⁷ / ₈ " x 1 ³ / ₈ " x 9 ³ / ₈ "
Finish	BK - Black WH - White
IP	20

Diffuse

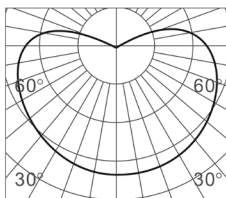

h(m)	E(lx)	Φ(m)
1	24	Φ2
2	6	Φ4
3	2	Φ6
4	1	Φ8
5	0.9	Φ10

TITANIUM

TECHNOLOGY

TT-TRK-L

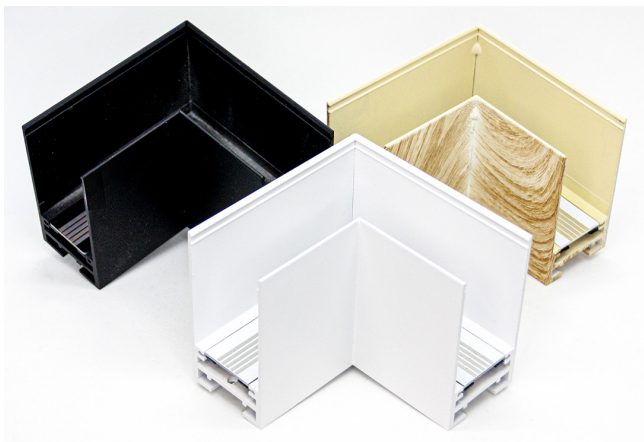

- Corner

Size	39 x 76 x 90 mm 1 9/16" x 3" x 3 9/16"
Finish	BK - Black W - White WOOD - Wood

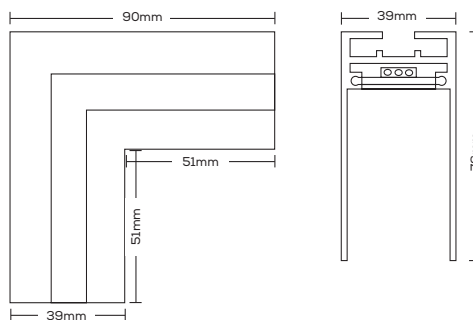

TT-TRK-Lo



- Outside corner union

Size	39 x 76 x 123 mm 1 9/16" x 3" x 4 7/8"
Finish	BK - Black W - White WOOD - Wood

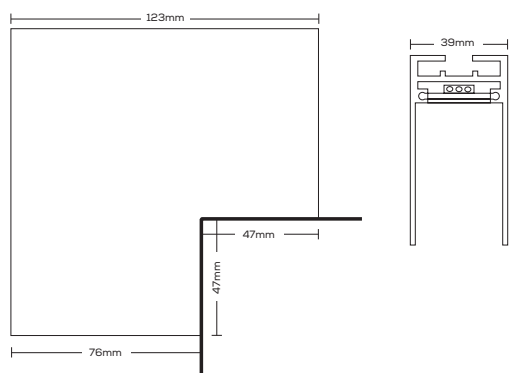

TITANIUM

TECHNOLOGY

TT-TRK-Li

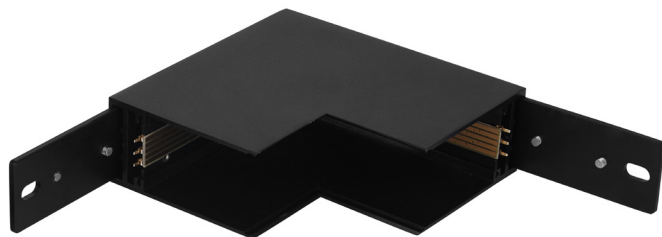

- Union interior corner

Size	39 x 76 x 123 mm 1 9/16" x 3" x 4 7/8"
Finish	BK - Black W - White WOOD - Wood

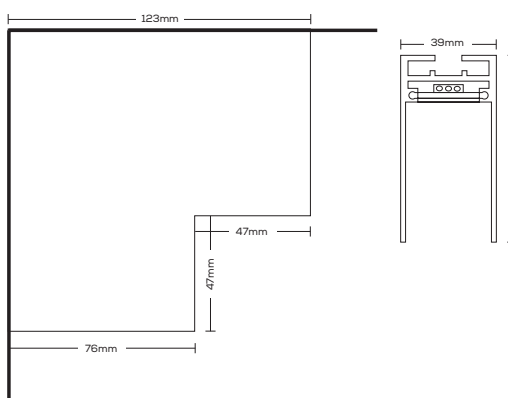

TT-TRK-T

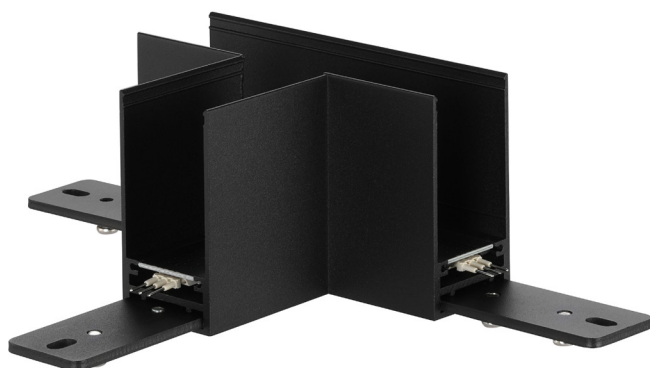

- T Corner

Size	39 x 76 x 141 mm 1 9/16" x 3" x 5 9/16"
Finish	BK - Black W - White WOOD - Wood

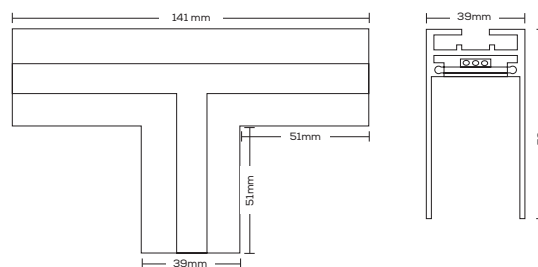

TITANIUM

TECHNOLOGY

TT-TRK-X



- X Corner

Size	39 x 76 x 141 mm 1 9/16" x 3" x 5 9/16"
Finish	BK - Black W - White WOOD - Wood

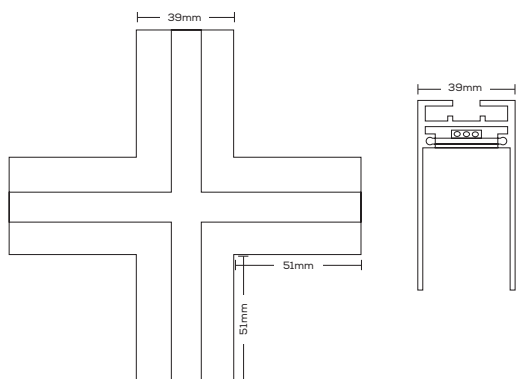

TT-TRK-V



- V Corner

Size	39 x 76 x 110 mm 1 9/16" x 3" x 5 9/16"
Finish	BK - Black W - White WOOD - Wood

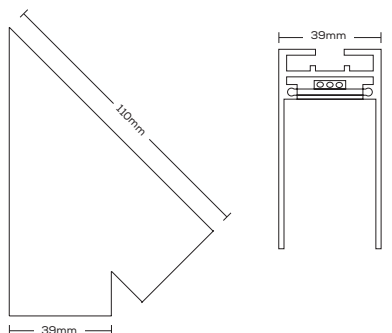

TITANIUM

TECHNOLOGY

TT-TRK-L-PL

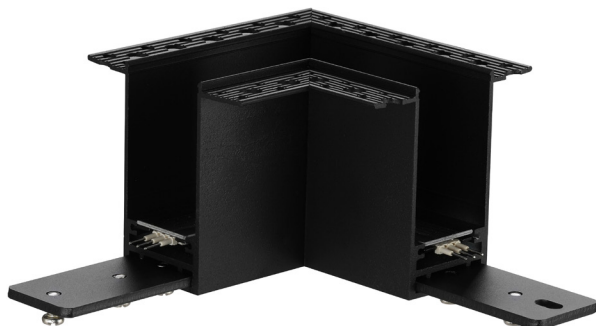

- Corner

Size	39 x 76 x 90 mm 1 9/16" x 3" x 3 9/16"
Finish	BK - Black W - White

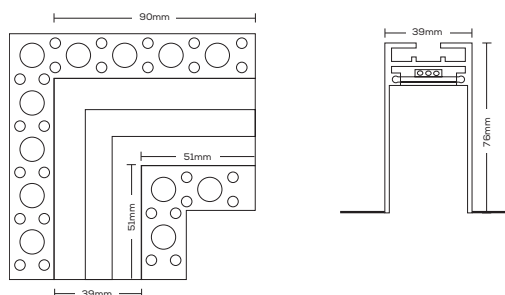

TT-TRK-Lo-PL

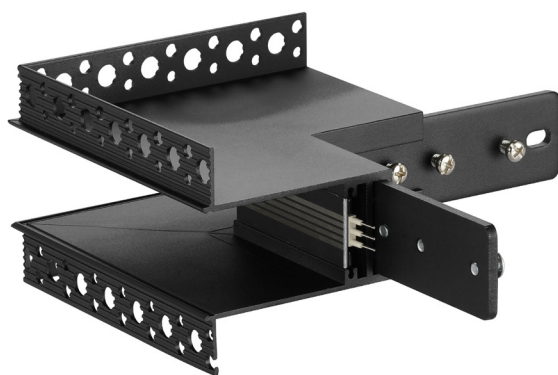

- Outside corner union

Size	39 x 76 x 90 mm 1 9/16" x 3" x 3 9/16"
Finish	BK - Black W - White

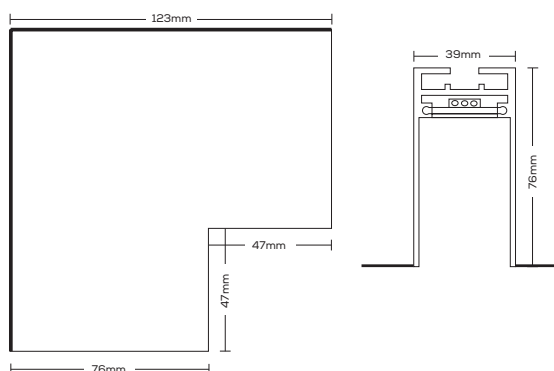

TITANIUM

TECHNOLOGY

TT-TRK-Li-PL



- Union interior corner

Size	39 x 76 x 90 mm 1 9/16" x 3" x 3 9/16"
Finish	BK - Black W - White

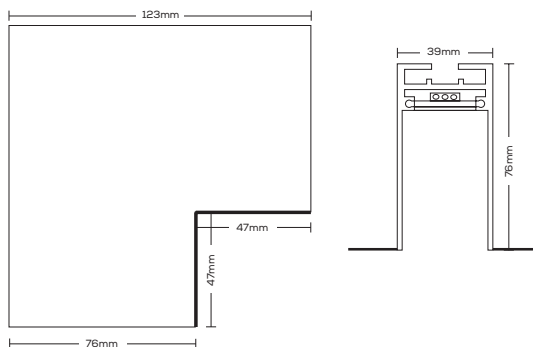

TT-TRK-T-PL



- T Corner

Size	39 x 76 x 141 mm 1 9/16" x 3" x 5 9/16"
Finish	BK - Black W - White

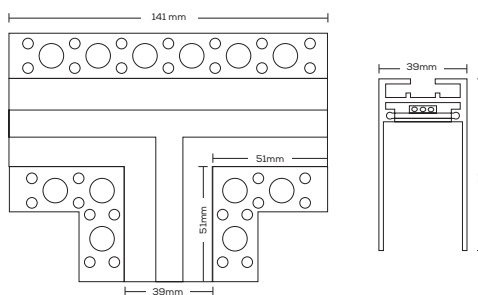

TITANIUM

TECHNOLOGY

TT-TRK-END



- End cap.

Size	39 x 76 x 2.5mm 1 ⁹ / ₁₆ " x 3" x 1 ¹ / ₈ "
Finish	BK - Black W - White WOOD - Wood

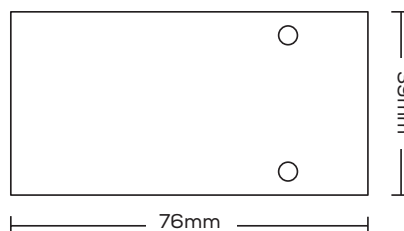

TT-TRK-CLIP



- Clip

Size	43 x 67 x 39 mm 1 ¹¹ / ₁₆ " x 2 ⁵ / ₈ " x 1 ⁹ / ₁₆ "
Finish	BK - Black W - White

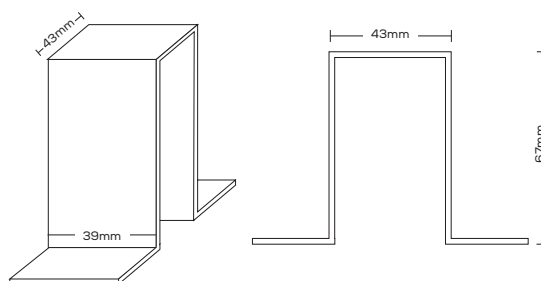

TITANIUM

TECHNOLOGY

TT-TRK-COVER



Size	36 x 1000 mm x 2.5mm 1 7/16" x 39 3/8" x 1/8"
Finish	BK - Black W - White WOOD - Wood

- Blank cover

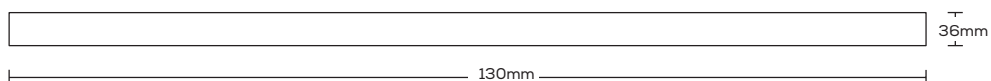

TT-TRK-EXT



Size	130 x 33 x 4 mm 5 1/8" x 1 5/16" x 3/16"
Finish	BK - Black W - White WOOD - Wood

- Junction bar

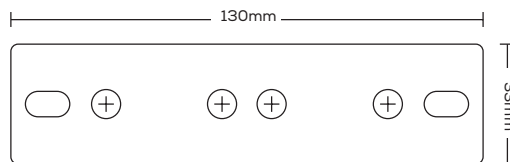

TITANIUM

TECHNOLOGY

TT-TRK-O

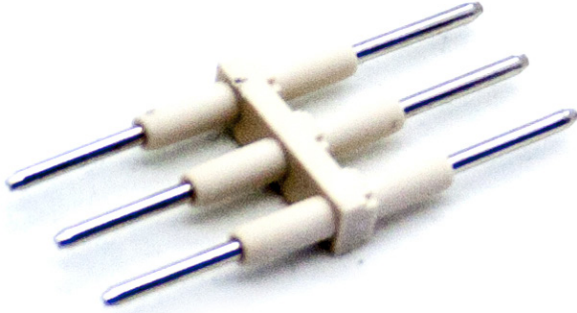

Size	26 x 11 x 3 mm 1" x ⁷ / ₁₆ " x ¹ / ₈ "
------	---

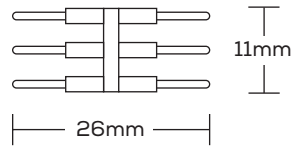

- Pin for electrical conductor

TT-TRK-I

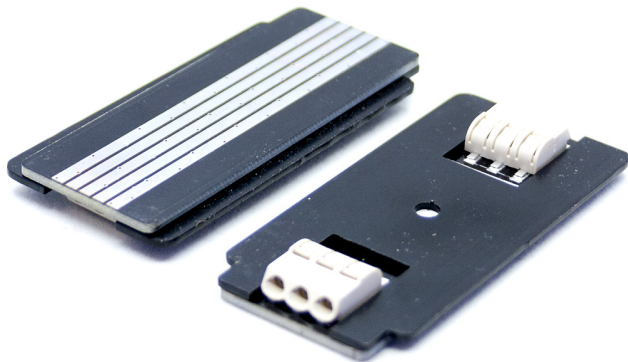

Size	65 x 31 x 3 mm 2 ⁹ / ₁₆ " x 1 ¹ / ₄ " x ¹ / ₈ "
Finish	BK - Black

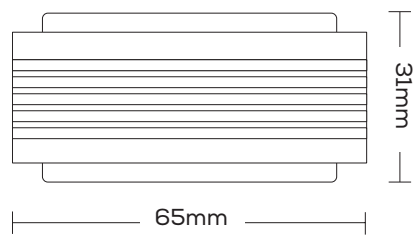

- Electrical conductor

TITANIUM

TECHNOLOGY

TT-TRK-SUSP-A



- Suspension kit

Size	Ø80 x 30 mm Ø3 3/16" x 1 3/16"
Finish	BK - Black W - White

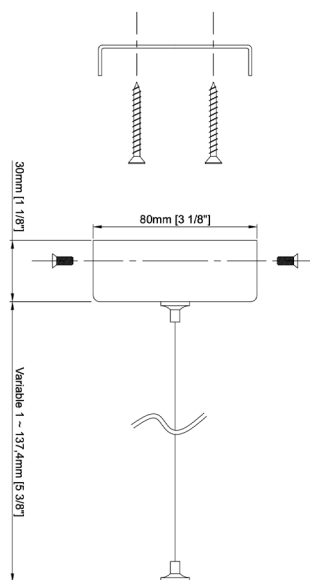

TT-TRK-SUSP-B



- Suspension kit with power cord.

Size	Ø80 x 30 mm Ø3 3/16" x 1 3/16"
Finish	BK - Black W - White

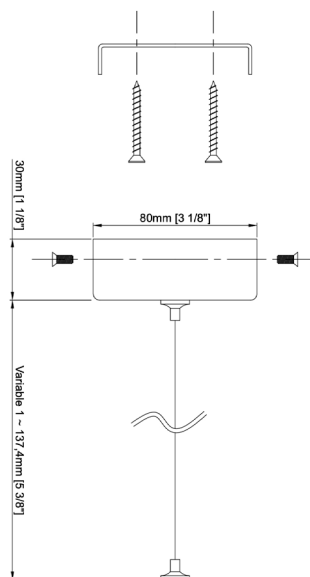

TITANIUM

TECHNOLOGY

TT-TRK-CONNECT-PL



Size	39 x 76 x 47 mm
	1 9/16" x 3" x 1 7/8"
Finish	BK - Black
	W - White

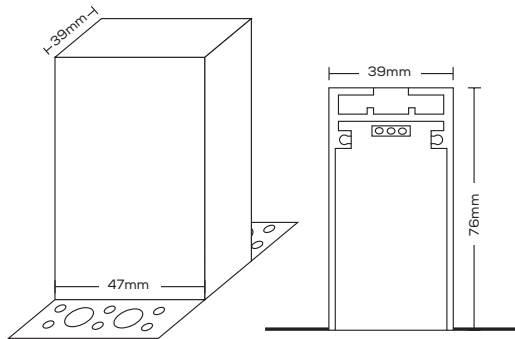

- Power junction.

TT-TRK-CONNECT

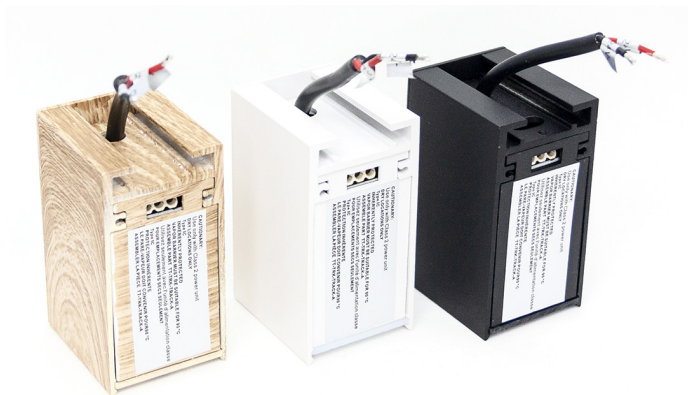

Size	39 x 76 x 47 mm
	1 9/16" x 3" x 1 7/8"
Finish	BK - Black
	W - White
	WOOD - Wood

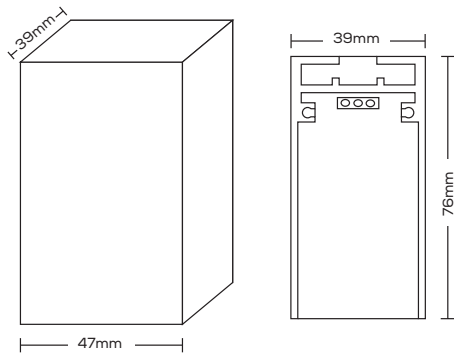

- Power junction.

TITANIUM

TECHNOLOGY

SUSPENDED CONFIGURATIONS

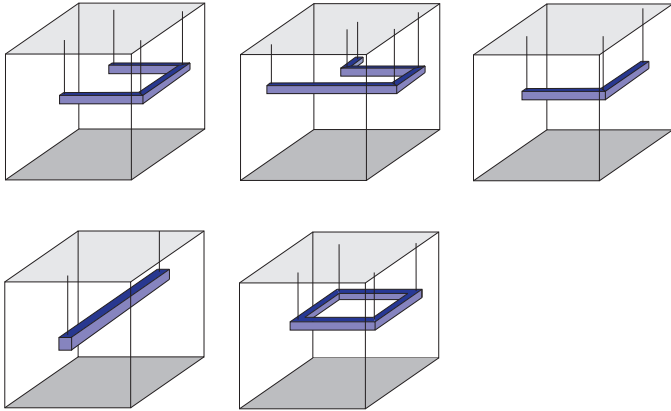

WALL ONLY CONFIGURATIONS

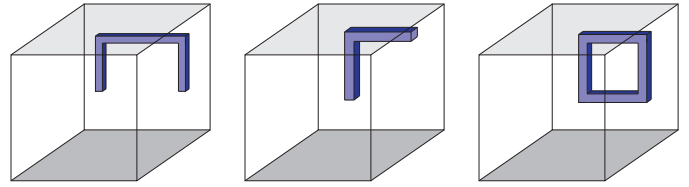

CEILING ONLY CONFIGURATIONS

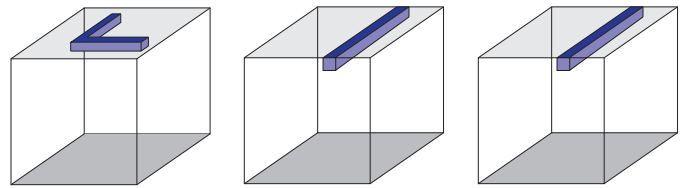

WALL TO CEILING CONFIGURATIONS

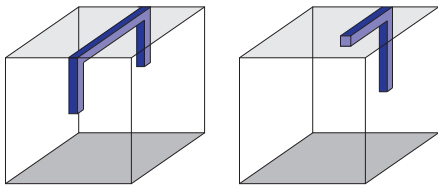

WALL TO WALL CONFIGURATIONS

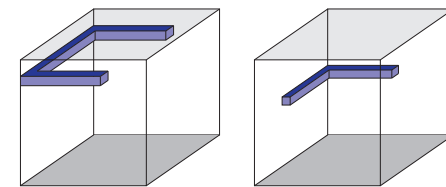

SEGMENT STANDARD LENGTHS

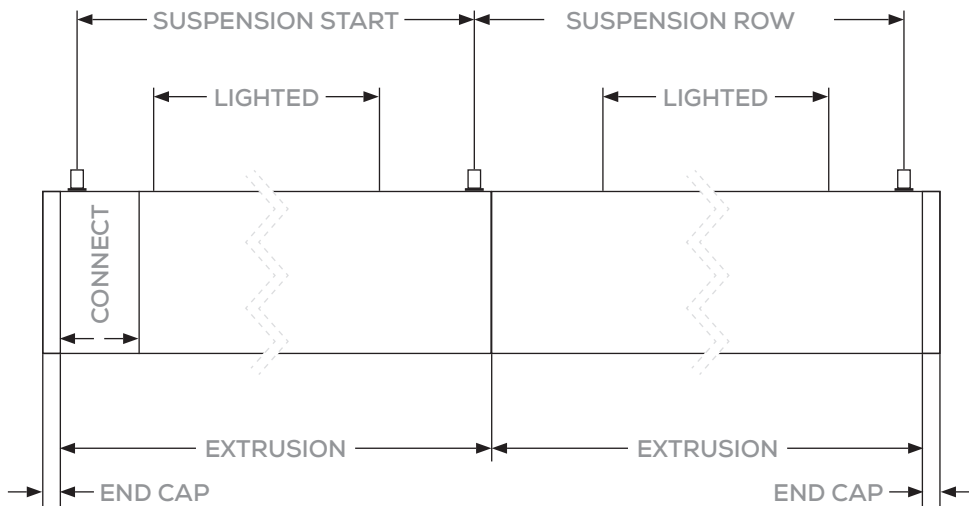

MAXIMUM MODULE QUANTITY PER DRIVER

Maximum quantity of fixtures per driver are calculated by dividing the maximum DC load (200w) by the DC power consumption per module. For example, a maximum of TT-TRK-640 can be powered by a single power feed: $200w \div 26w = 7$ units. A variety of different fixtures are available and combining several fixtures is possible and recommended.

TT-DR-CV-200-BOX



- Transformers dimmable to the primary 120vAC.
- 160 watts maximum load.
- Minimum load of 1 watts.
- Triac dimmable from 5% to 100%

Voltage in	120vAC	
Voltage out	12vDC	24vDC
Amperage in	3,2A	3,2A
Amperage out	16,6A	8,3A
Power	200w	
Minimum Load	1w	
Size	405mm x 85mm x 63mm 16" x 3 3/8" x 2 1/2"	
Dimmable	Yes - Foward phase, Magnetic low volage 5% ~100% Triac	
IP	66	

TT-DR-CV-384-24V-BOX-5IN1



- Transformers dimmable to the primary 120vAC.
- 4 x out 96w.
- 5 in 1
- Class 2

Voltage in	120vAC	
Voltage out	24vDC Class 2	
Amperage in	4,8A	
Amperage out	4 x 4A	
Power	4 x 96w	
Size	405mm x 85mm x 63mm 16" x 3 3/8" x 2 1/2"	
Dimmable	Yes 5% ~100% Triac 0-10V Potentiometer 10V PWM	
IP	66	
Dimming	Triac 0-10V Potentiometer 10V pwm Phase	

Surface mounted

Caution : This system is a LOW Voltage DC24V product

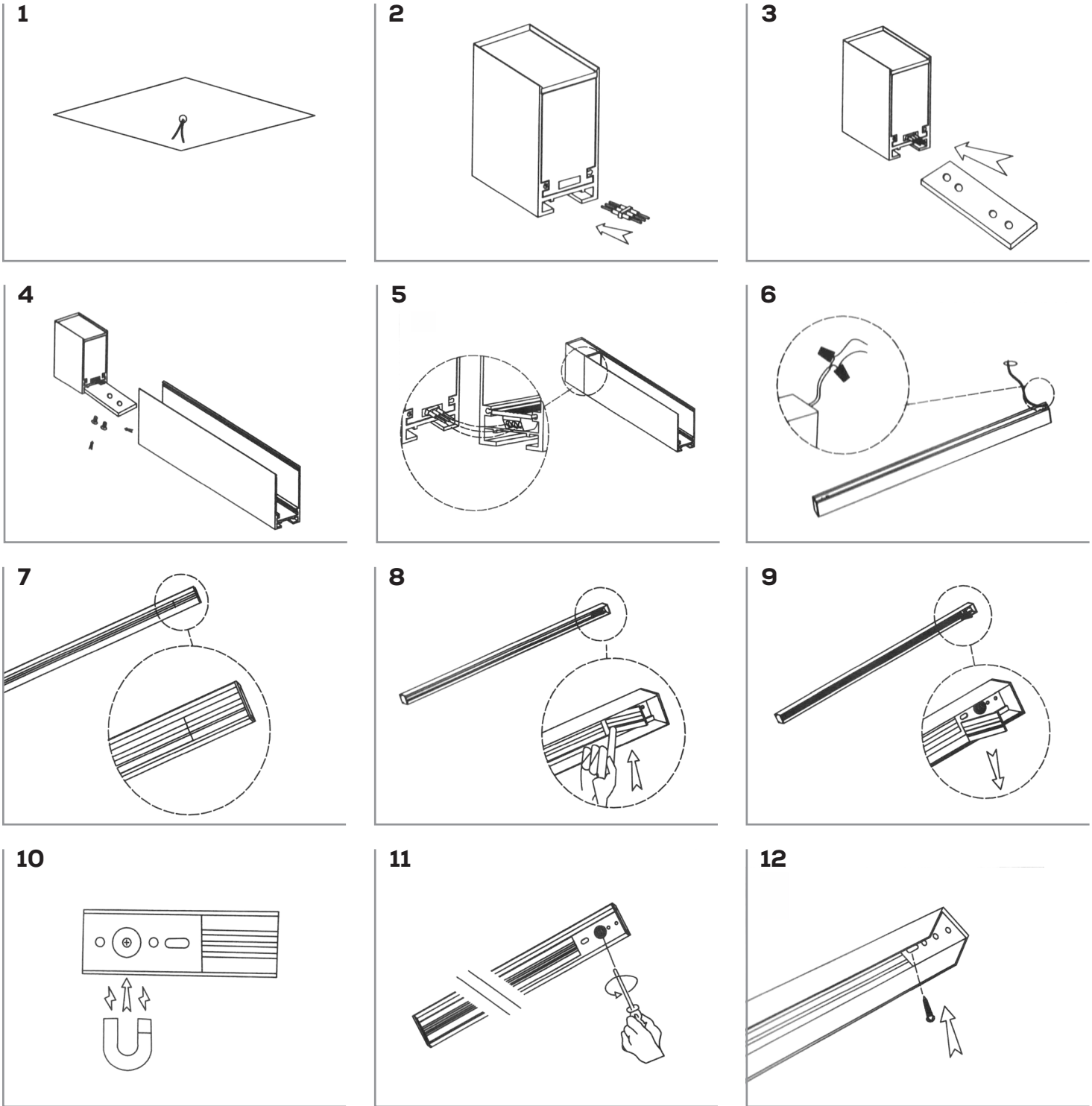

Surface mounted (continued)

13

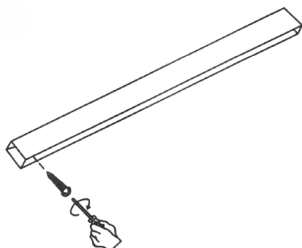

14

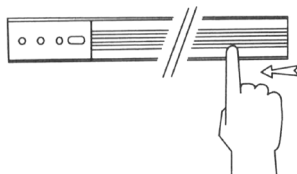

15

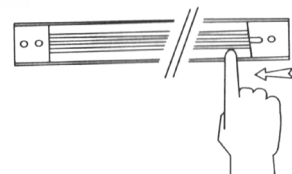

16

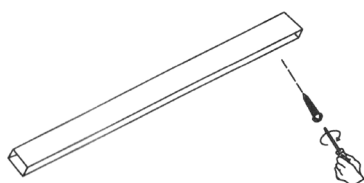

17

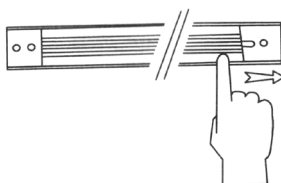

18

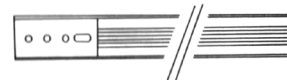

19

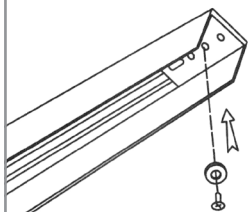

20

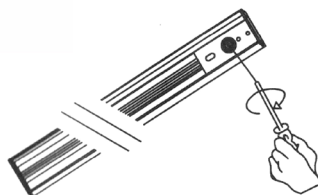

21

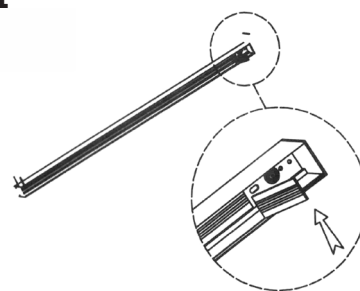

22

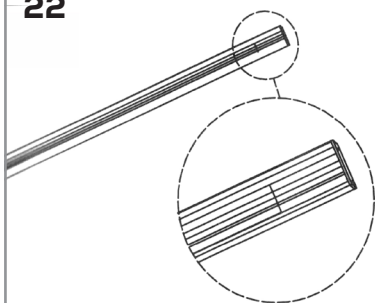

23

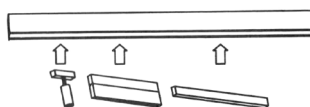

24



Recessed mounted

1

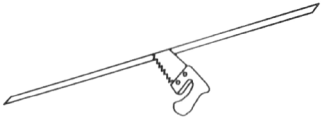

2

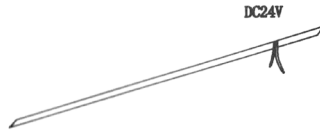

3

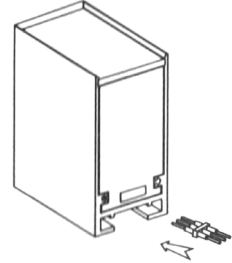

4

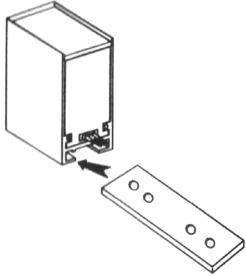

5

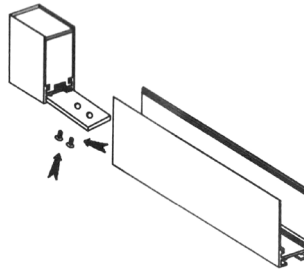

6

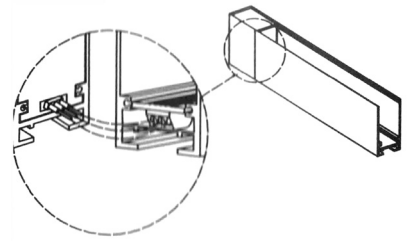

7

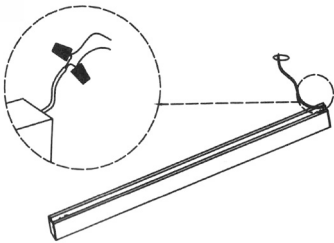

8

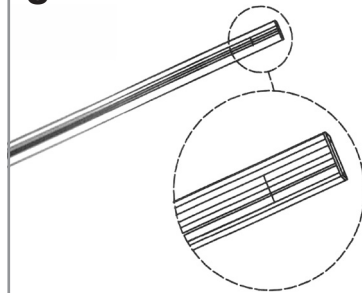

9

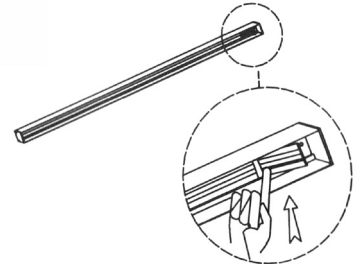

10

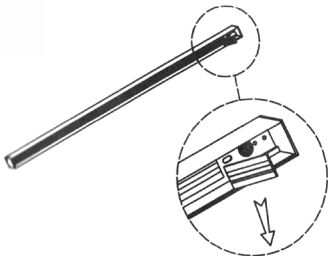

11

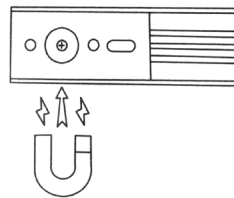

12

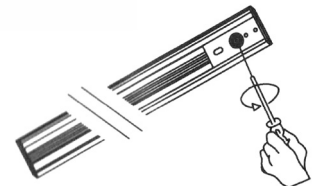

Recessed mounted (continued)

13



14

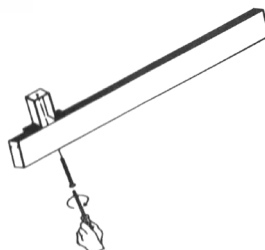

15

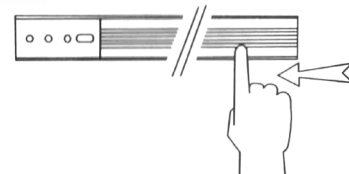

16

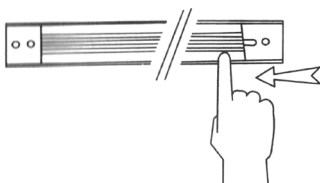

17

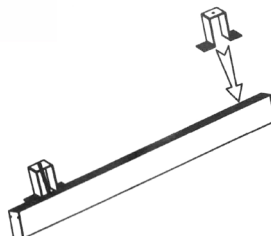

18

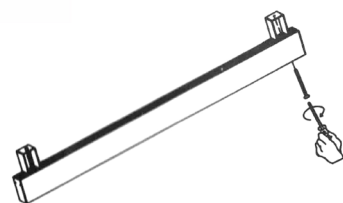

19

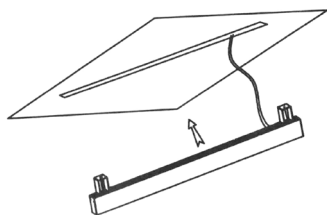

20

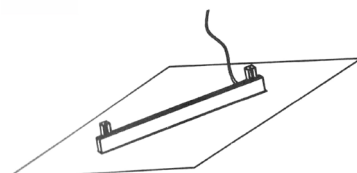

21

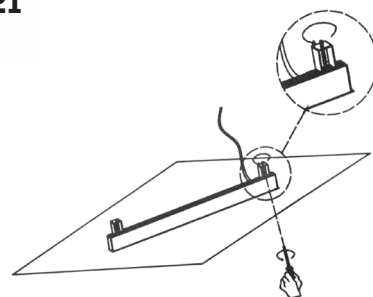

22

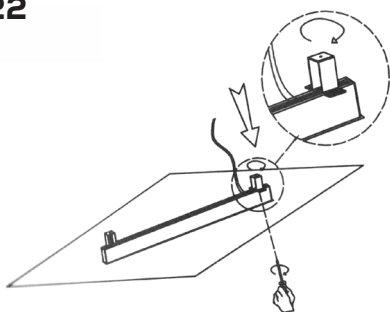

23

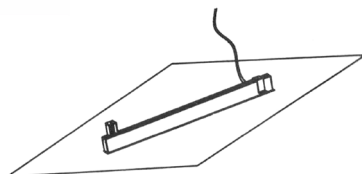

24

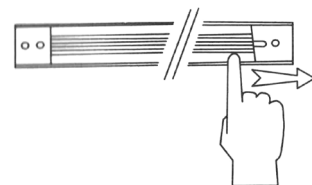

TITANIUM

TECHNOLOGY

Recessed mounted (continued)

25

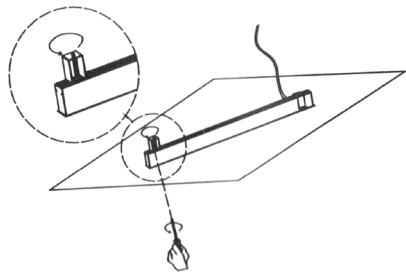

26

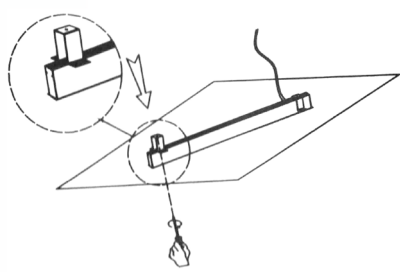

27

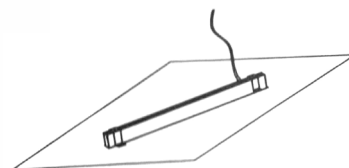

28



29

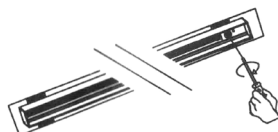

30

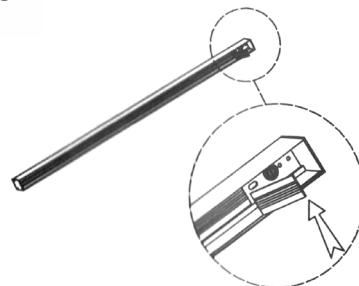

31

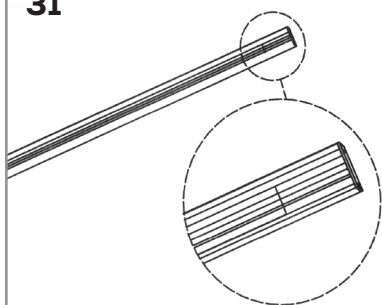

32



33

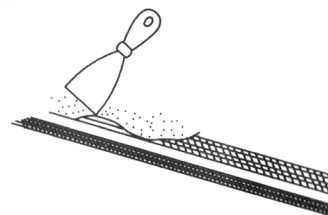

34

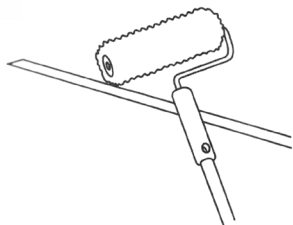

35

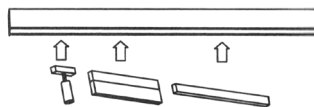

36



Pendant mounted

1

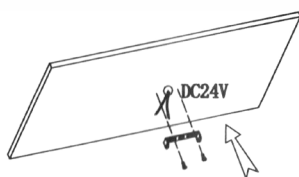

2

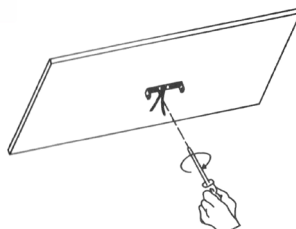

3

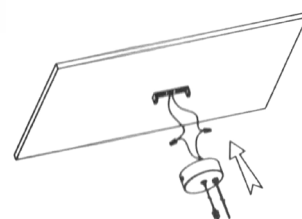

4

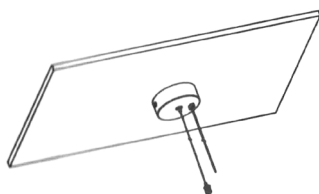

5

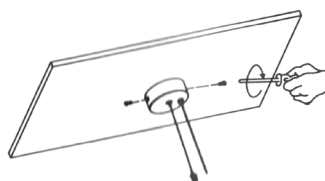

6

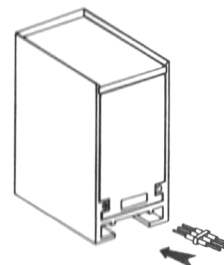

7

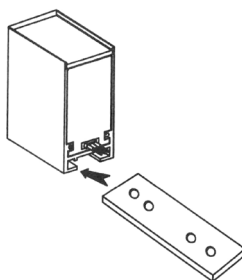

8

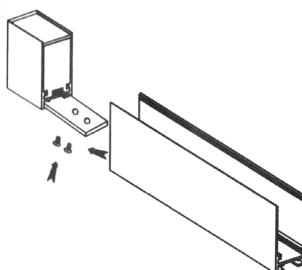

9

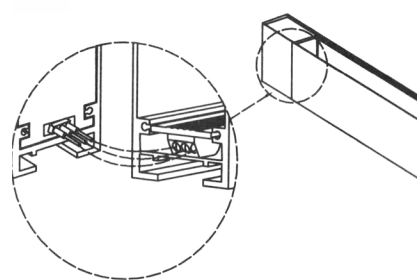

10

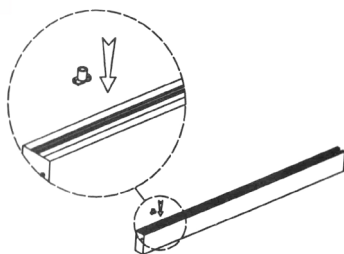

11

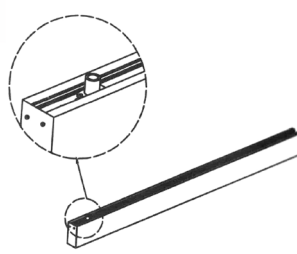

12

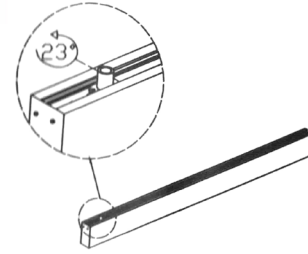

Pendant mounted (continued)

13

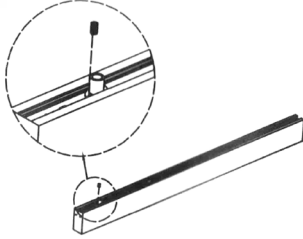

14

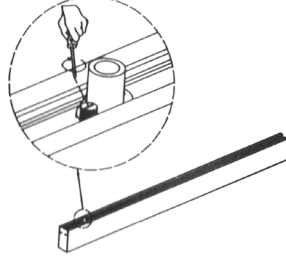

15

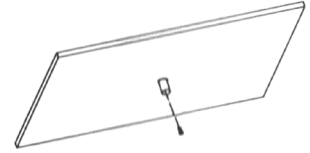

16

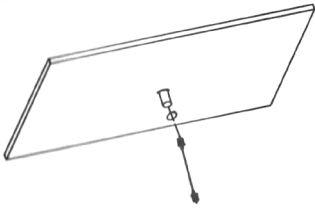

17

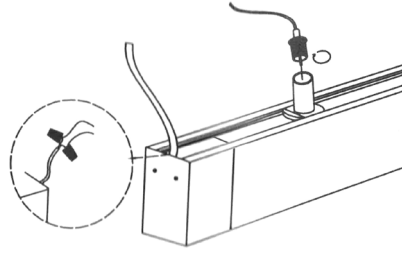

18

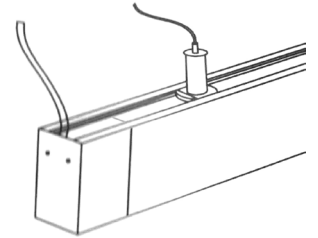

19

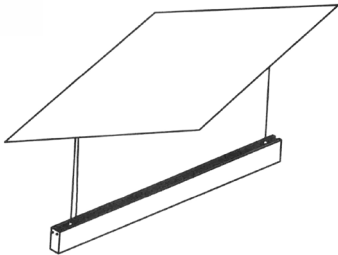

Recessed mounted with trim

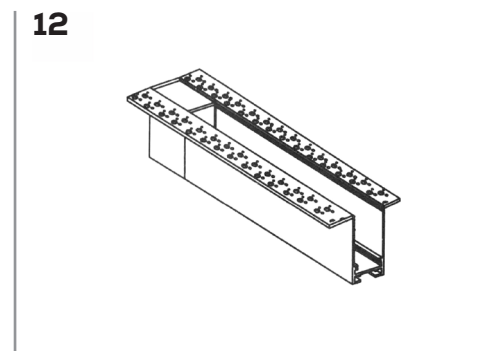
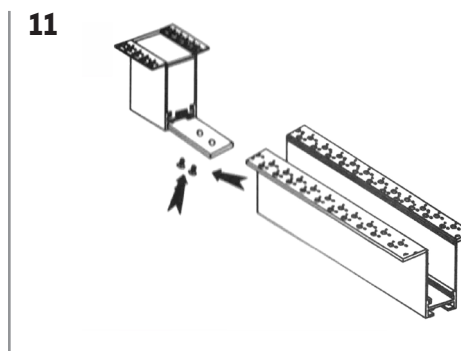
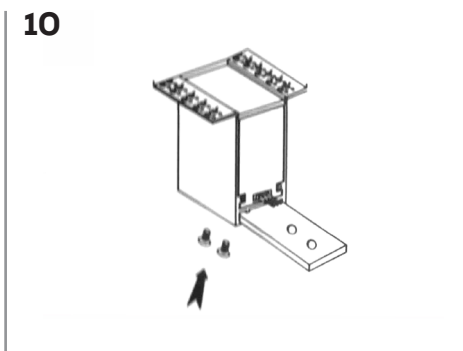
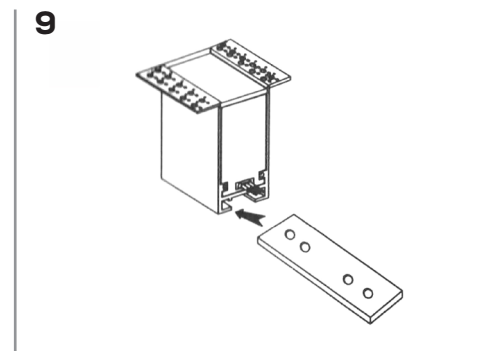
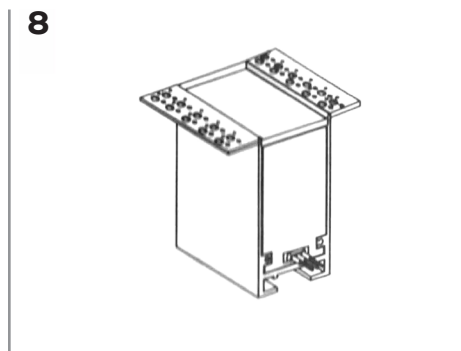
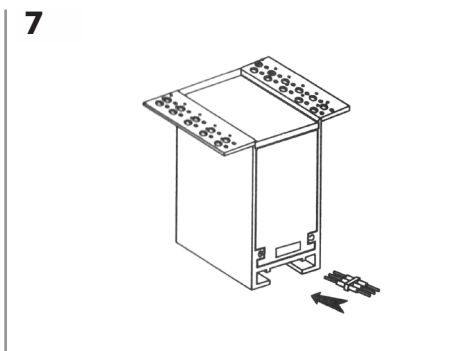
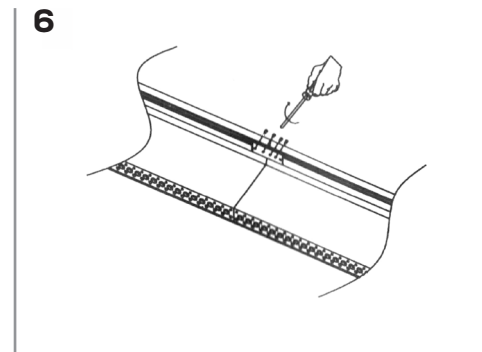
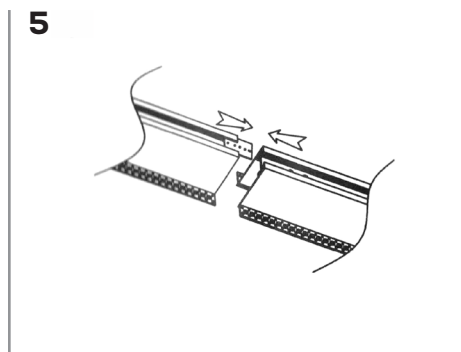
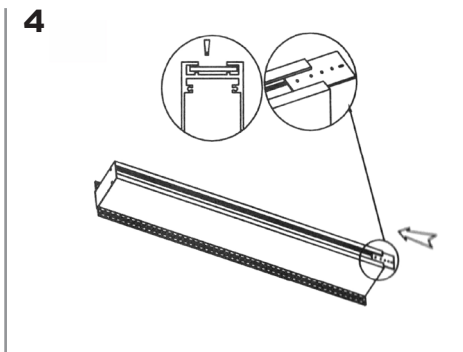
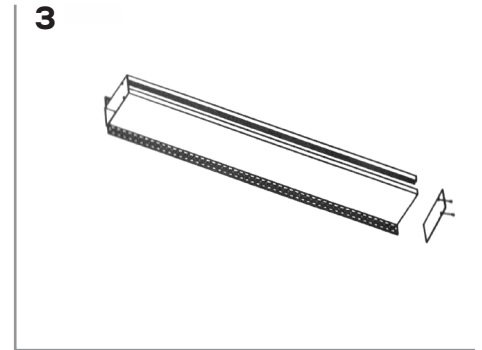
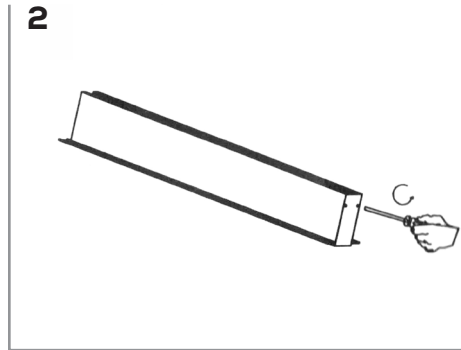
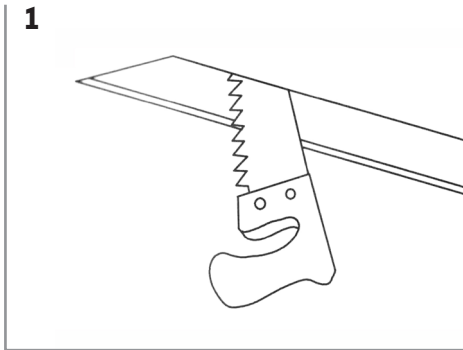

Recessed mounted with trim (continued)

13

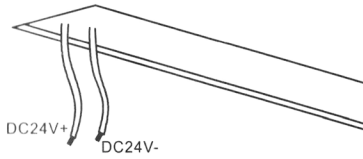

14

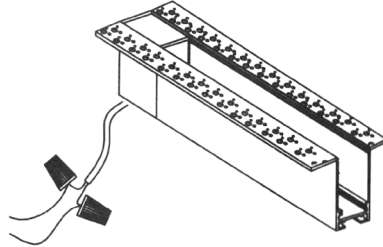

15

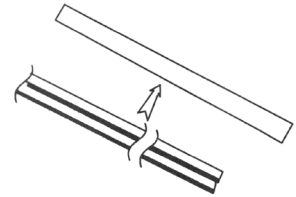

16

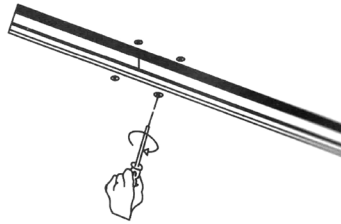

17



18

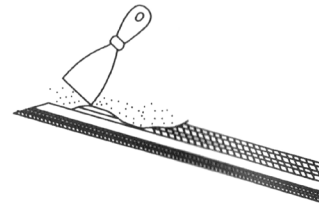

19

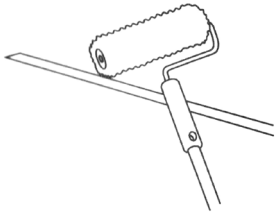

20

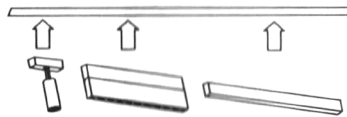

21



Input terminal connection

1

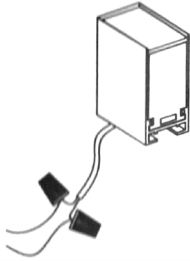

2

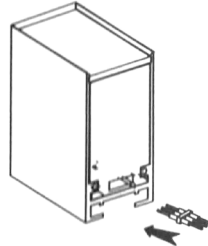

3

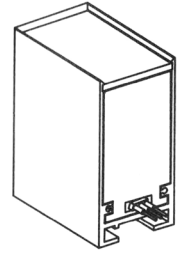

4

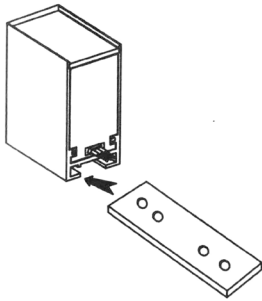

5

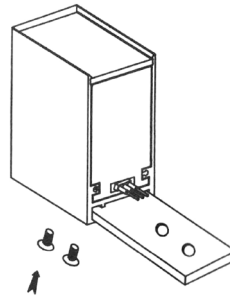

6

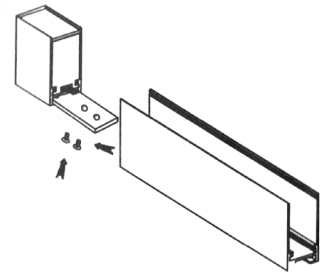

7

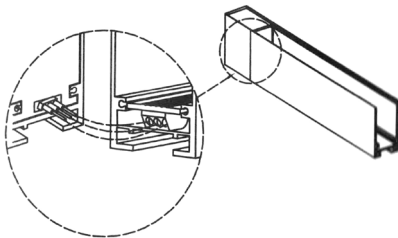

8

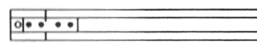

Surface mount kit

1

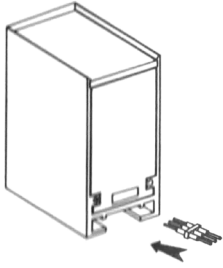

2

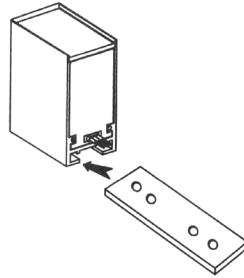

3

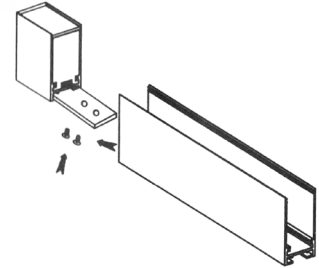

4

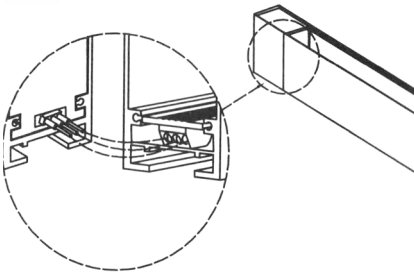

5



6



7

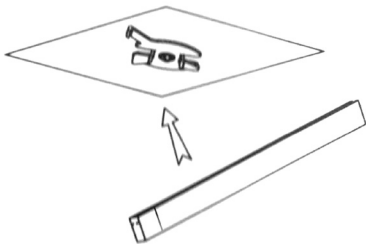

8

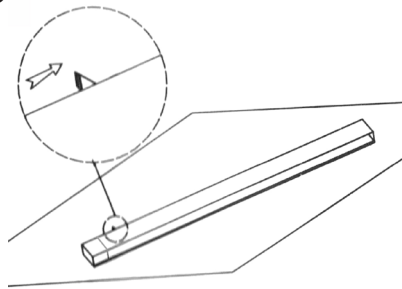

9

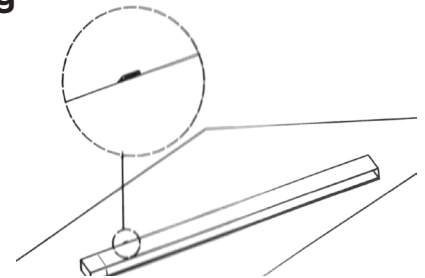

10

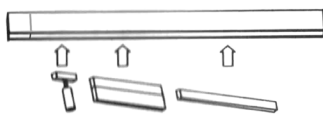

TITANIUM

TECHNOLOGY

Track connection

1

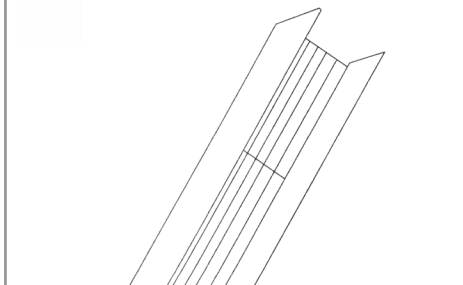

2

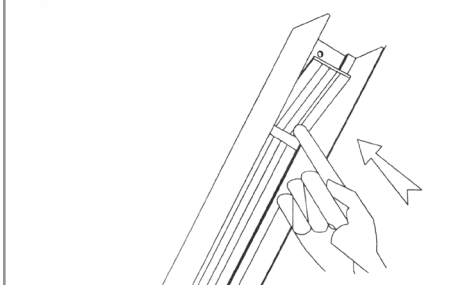

3

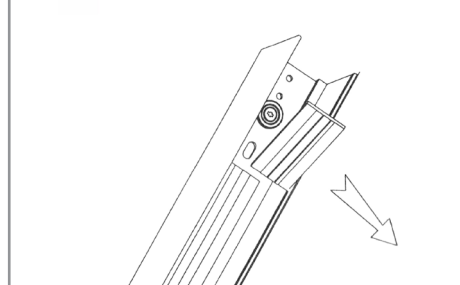

4

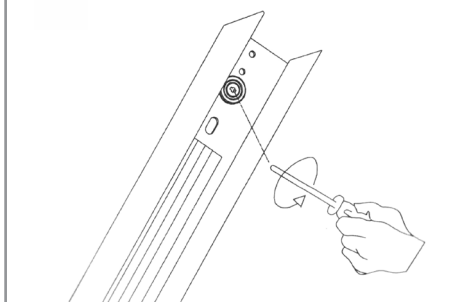

5

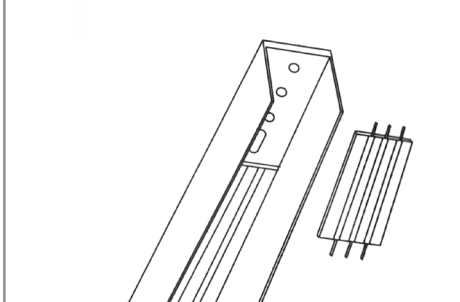

6

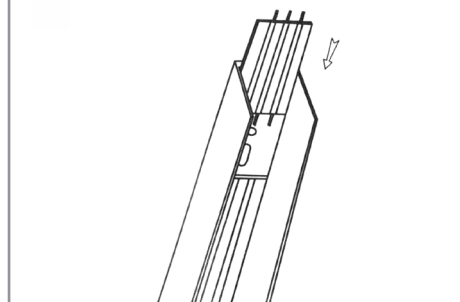

7

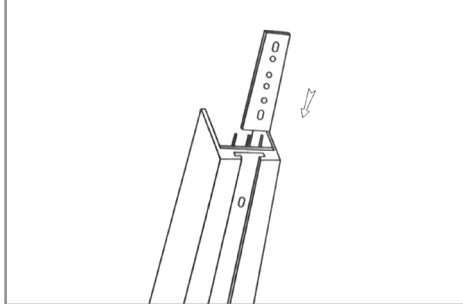

8

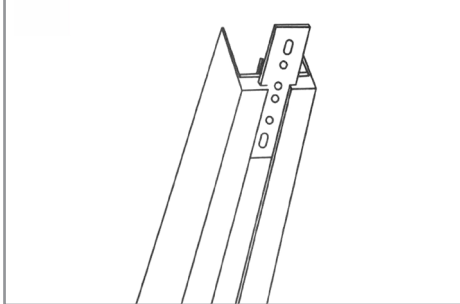

9

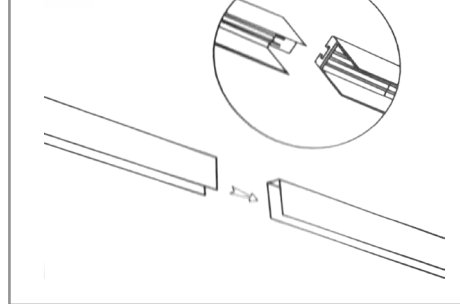

10

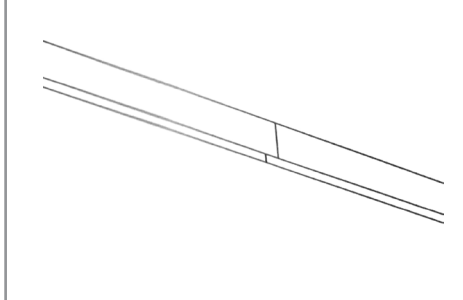

Track connection with connector

1

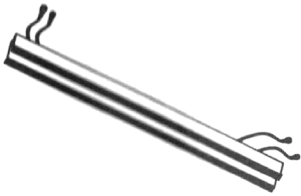

2

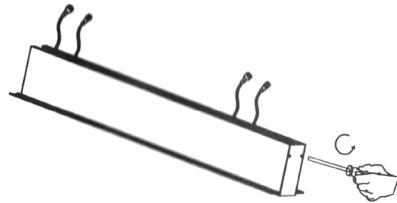

3

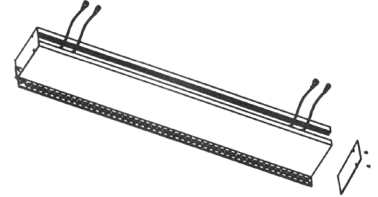

4

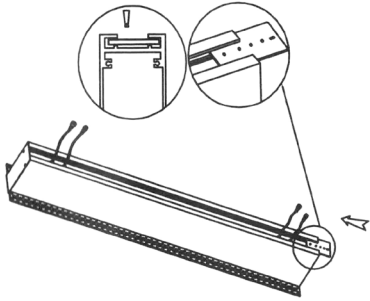

5

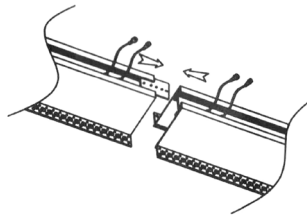

6

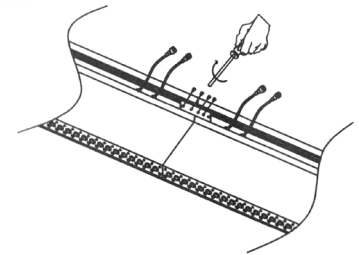

7

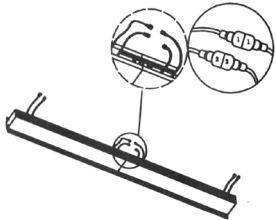

8

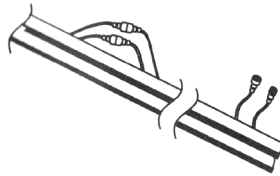

Run Length	Segment breakdown
465 mm	Single
530 mm	465 + 65
595 mm	465 + 65 + 65
605 mm	465 + 140
660 mm	465 + 65 + 65 + 65
670 mm	465 + 140 + 65
735 mm	465 + 140 + 65 + 65
745 mm	465 + 140 + 140
800 mm	465 + 140 + 65 + 65 + 65
810 mm	465 + 140 + 140 + 65
875 mm	465 + 140 + 140 + 65 + 65
885 mm	465 + 140 + 140 + 140
930 mm	465 + 465
995 mm	465 + 465 + 65
1060 mm	465 + 465 + 65 + 65
1070 mm	465 + 465 + 140
1125 mm	465 + 465 + 65 + 65 + 65
1135 mm	465 + 465 + 140 + 65
1200 mm	465 + 465 + 140 + 65 + 65
1210 mm	465 + 465 + 140 + 140
1265 mm	465 + 465 + 140 + 65 + 65 + 65
1275 mm	465 + 465 + 140 + 140 + 65
1340 mm	465 + 465 + 140 + 140 + 65 + 65
1350 mm	465 + 465 + 140 + 140 + 140

Run Length	Segment breakdown
1395 mm	465 + 465 + 465
1460 mm	465 + 465 + 465 + 65
1525 mm	465 + 465 + 465 + 65 + 65
1535 mm	465 + 465 + 465 + 140
1590 mm	465 + 465 + 465 + 65 + 65 + 65
1600 mm	465 + 465 + 465 + 140 + 65
1665 mm	465 + 465 + 465 + 140 + 65 + 65
1675 mm	465 + 465 + 465 + 140 + 140
1730 mm	465 + 465 + 465 + 140 + 65 + 65 + 65
1740 mm	465 + 465 + 465 + 140 + 140 + 65
1805 mm	465 + 465 + 465 + 140 + 140 + 65 + 65
1815 mm	465 + 465 + 465 + 140 + 140 + 140
1860 mm	465 + 465 + 465 + 465
1925 mm	465 + 465 + 465 + 465 + 65
1990 mm	465 + 465 + 465 + 465 + 65 + 65
2000 mm	465 + 465 + 465 + 465 + 140
2055 mm	465 + 465 + 465 + 465 + 65 + 65 + 65
2065 mm	465 + 465 + 465 + 465 + 140 + 65
2130 mm	465 + 465 + 465 + 465 + 140 + 65 + 65
2140 mm	465 + 465 + 465 + 465 + 140 + 140
2195 mm	465 + 465 + 465 + 465 + 140 + 65 + 65 + 65
2205 mm	465 + 465 + 465 + 465 + 140 + 140 + 65
2270 mm	465 + 465 + 465 + 465 + 140 + 140 + 65 + 65
2280 mm	465 + 465 + 465 + 465 + 140 + 140 + 140

Run Length	Segment breakdown
2325 mm	465 + 465 + 465 + 465 + 465
2390 mm	465 + 465 + 465 + 465 + 465 + 65
2455 mm	465 + 465 + 465 + 465 + 465 + 65 + 65
2465 mm	465 + 465 + 465 + 465 + 465 + 140
2520 mm	465 + 465 + 465 + 465 + 465 + 65 + 65 + 65
2530 mm	465 + 465 + 465 + 465 + 465 + 140 + 65
2595 mm	465 + 465 + 465 + 465 + 465 + 140 + 65 + 65
2605 mm	465 + 465 + 465 + 465 + 465 + 140 + 140
2660 mm	465 + 465 + 465 + 465 + 465 + 140 + 65 + 65 + 65
2670 mm	465 + 465 + 465 + 465 + 465 + 140 + 140 + 65
2735 mm	465 + 465 + 465 + 465 + 465 + 140 + 140 + 65 + 65
2745 mm	465 + 465 + 465 + 465 + 465 + 140 + 140 + 140
2790 mm	465 + 465 + 465 + 465 + 465 + 465
2855 mm	465 + 465 + 465 + 465 + 465 + 465 + 65
2920 mm	465 + 465 + 465 + 465 + 465 + 465 + 65 + 65
2930 mm	465 + 465 + 465 + 465 + 465 + 465 + 140
2985 mm	465 + 465 + 465 + 465 + 465 + 465 + 65 + 65 + 65
2995 mm	465 + 465 + 465 + 465 + 465 + 465 + 140 + 65

PATTERN TYPICAL SEGMENT BREAKDOWN IN MM

This section is to detail how each linear runs of your patterns will be divided in standard length segments.

End caps of 2.5mm each are not included in run length calculations.

Dimensions are always calculated from the center of the aircraft cable.

Refer to aircraft cable installation sheet to properly install your mounting points.

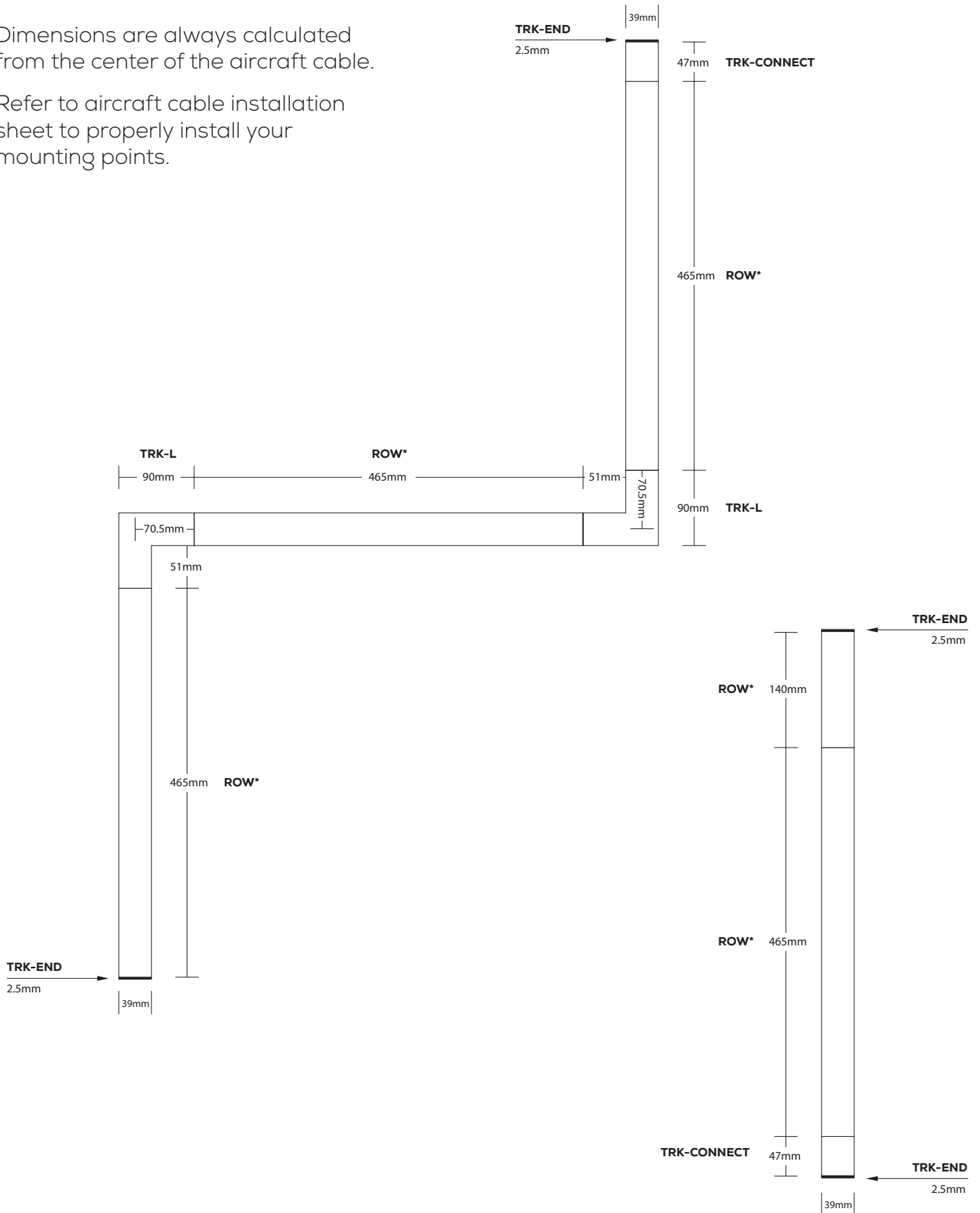

*Please refer to page 80 in the run length section to select your desired row length.

Dimensions are always calculated from the center of the aircraft cable.

Refer to aircraft cable installation sheet to properly install your mounting points.

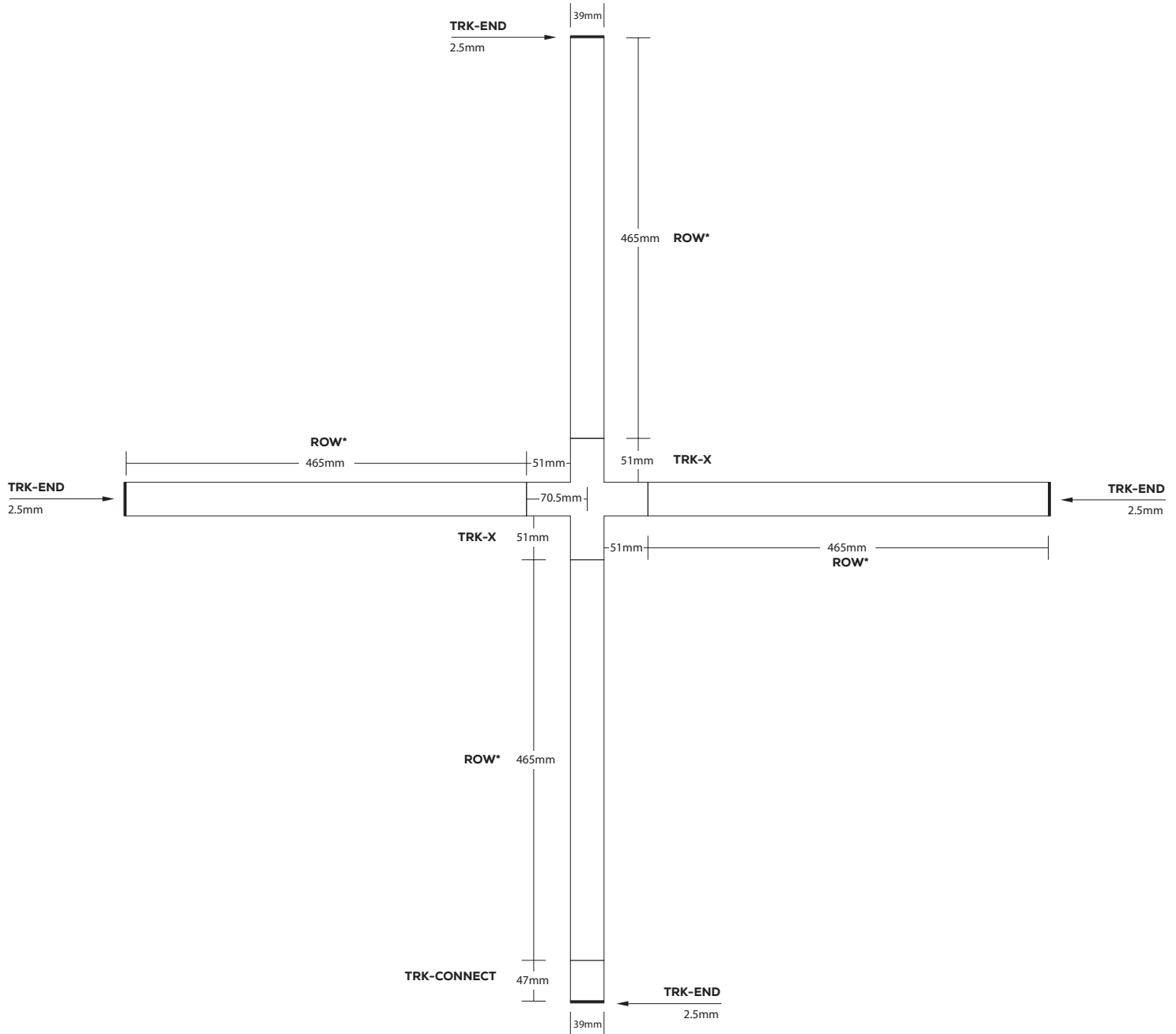

*Please refer to page 80 in the run length section to select your desired row length.

Dimensions are always calculated from the center of the aircraft cable.

Refer to aircraft cable installation sheet to properly install your mounting points.

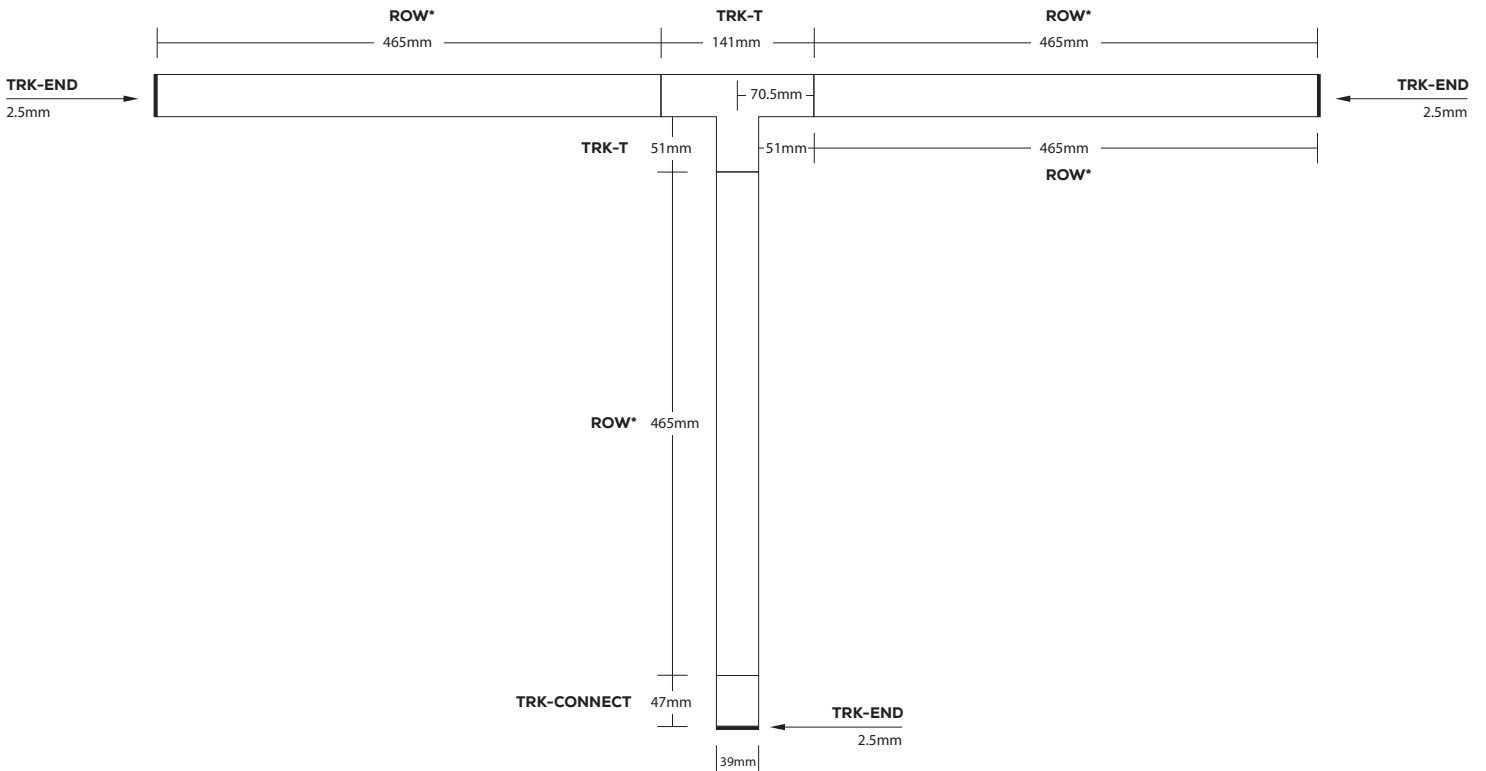
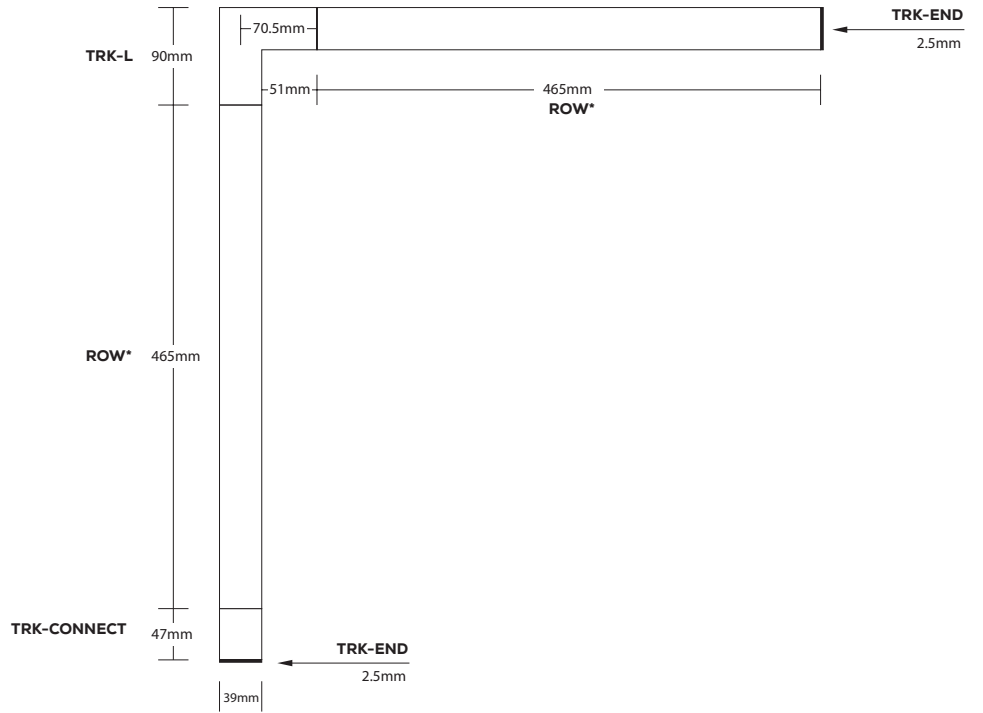

*Please refer to page 80 in the run length section to select your desired row length.

Dimensions are always calculated from the center of the aircraft cable.

Refer to aircraft cable installation sheet to properly install your mounting points.

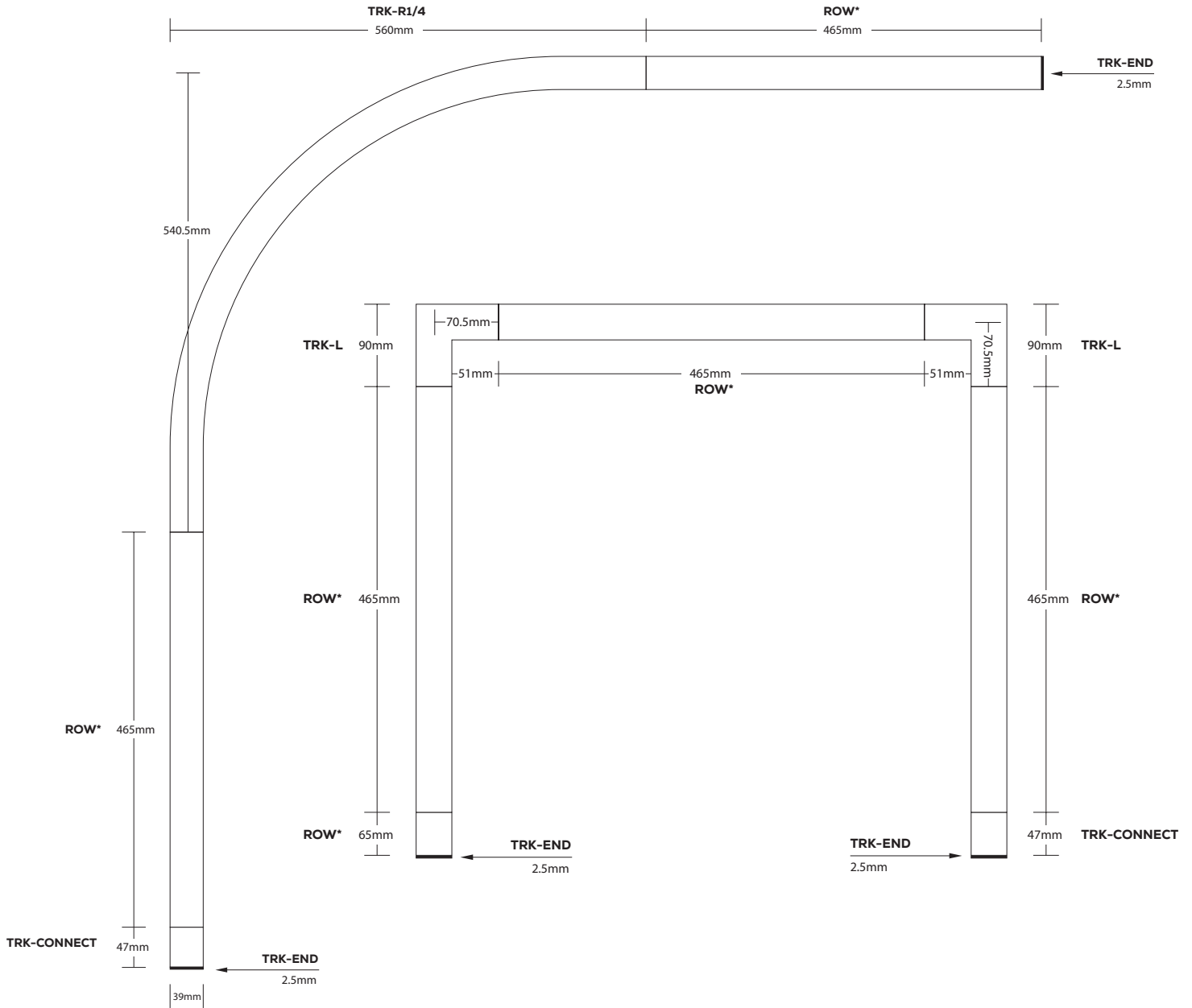

*Please refer to page 80 in the run length section to select your desired row length.

PRODUCT BUILDER CODE

TYPE	END CAP	SUSPENSION	CONNECT
SU Surface	END Yes	SUSP Yes	24V
PL Trimless mud-in	N/A No	N/A No	

RUN LENGTH DIMENSION (mm)	+	JUNCTION	+	RUN LENGTH DIMENSION (mm)	+	JUNCTION	+	RUN LENGTH DIMENSION (mm)	ETC ...
Refer to the table on page 80		L X T R1/8 R1/4 R1/2		Refer to the table on page 80		L X T R1/8 R1/4 R1/2		Refer to the table on page 80	

BUILD YOUR CODE

TYPE	END CAP	SUSPENSION	CONNECT

RUN LENGTH DIMENSION (mm)	+	JUNCTION	+	RUN LENGTH DIMENSION (mm)	+	JUNCTION	+	RUN LENGTH DIMENSION (mm)

JUNCTION	+	RUN LENGTH DIMENSION (mm)	+	JUNCTION	+	RUN LENGTH DIMENSION (mm)	+	JUNCTION

RUN LENGTH DIMENSION (mm)	+	JUNCTION	+	RUN LENGTH DIMENSION (mm)	+	JUNCTION	+	RUN LENGTH DIMENSION (mm)

TITANIUM

TECHNOLOGY

Date:

Project:

Type:

Note:



LIMITED TWO (2) YEARS WARRANTY

Titanium Technology offers this limited warranty for two (2) years from the date of purchase of this Titanium Technology product (hereafter : the «Product»). A list of all the Titanium Technology products covered by this limited warranty is given at the end of this document.



This limited warranty is valid only for the Product and it may not be transferred.

The present limited warranty is not meant to exclude, restrict, limit or modify the legal warranty given by law to the purchaser of the Product.

This is a quality Product. It was made and selected with care. If the Product contains a manufacturing defect or if one or more parts of the Product is defective, the retailer commits to replace or repair, at its sole discretion, the defective part of parts without charge under the following cumulative conditions : 1) the purchaser must contact the retail store where the Product was purchased; 2) the purchaser must return the defective part of parts or the Product to the retailer; 3) the purchaser must provide the retailer the invoice as proof of purchase and date of purchase of the Product; 4) the purchaser must supply the Product identification information, including the serial number or the model number; and 5) the period of two (2) years covered by this limited warranty must not be expired. If the retailer decides to replace the defective part or parts, the replacement part or parts would be new or reconditioned, equivalent to new parts.

EXCLUSIONS AND LIMITATIONS OF THE LIMITED WARRANTY

This limited warranty is not applicable :

1. to consumable parts;
2. to normal wear;
3. when the Product is used for purposes other than those determined by the manufacturer;
4. when the Product is not installed by a qualified electrician when electrical work is required;
5. when the serial number or other identification information or the Product is erased or withdrawn;
6. to damages that are only aesthetic and do not affect the normal use of the Product, including scratches, bumps etc.;
7. to labour costs such as installation, de-installation or shipping of the Product which must be paid by the purchaser;
8. to service call costs, when the service call is made while the warranty is not valid;
9. when the damages, defects, faults or other problems arise from :
 - a. an abnormal use of the Product;
 - b. an inadequate maintenance of the Product;
 - c. a faulty installation of the Product or an installation that is not in accordance with the installation guide (if one is provided);
 - d. a modification, a repair or dismantling of the Product by a person not authorized by the retailer or the manufacturer;
 - e. the transportation by the purchaser, his employee, officer or representative;
 - f. a negligence by the purchaser, his employee, officer or representative;
 - g. an accident;
 - h. a case of force majeure (are considered force majeure : nature disasters, lightning, flood, fire etc.);
 - i. any event that is not caused by the Product itself.

In no circumstance can the manufacturer or retailer be held responsible for any extraordinary, special, indirect, accessory or consecutive damages resulting from the use of or the incapacity to use the Product. Their responsibility is limited to the sale price of the Product as indicated on the notice and paid by the purchaser at the time of purchase. It is understood that this is not meant to limit, restrict or exclude the protection given by the legal warranty.

FRENCH VERSION VS ENGLISH VERSION

In case of discrepancy between the French and the English versions of the text of this limited warranty, the French version shall prevail.

MODIFICATIONS

The present warranty text is subject to change at any time.

List of Titanium Technology products covered under this limited warranty :

- | | |
|------------------------------|--------------|
| 1) TT-LUS-XX | 4)TT-STEP-XX |
| 2) TT-PSU-IP67-XX (MEANWELL) | 5)TT-UGD-XX |
| 3) TT-TRK-XX | |

Note : This product list may not be up to date. Please refer to the product itself (including the package or installation guide) to make sure it is covered by this limited warranty.

TITANIUM

TECHNOLOGY

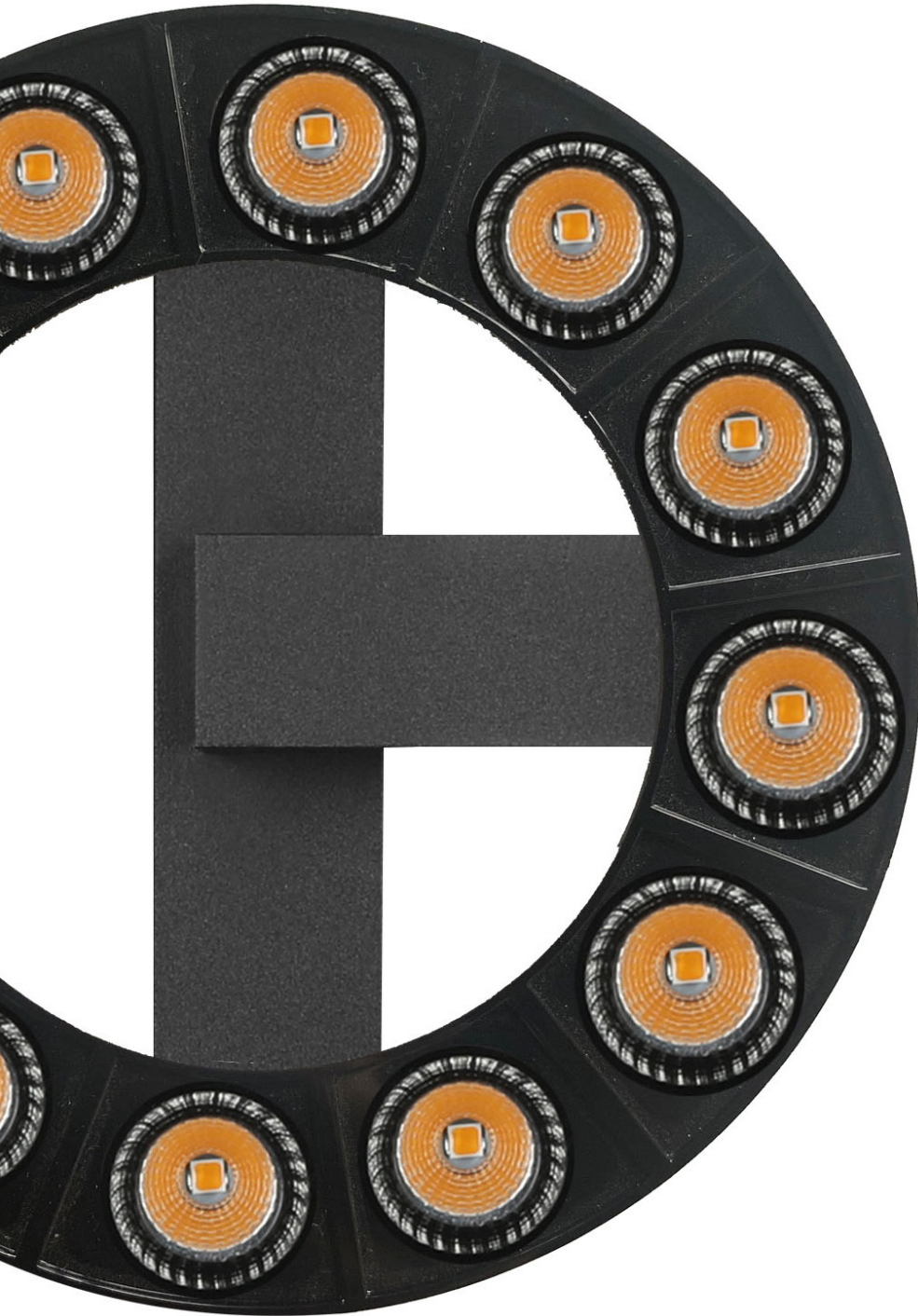

TITANIUM TECHNOLOGY
2323, boulevard Versant Nord #111
Québec, QC
G1N 4P4 CANADA
Toll free (866)-476-8115
www.titaniumtechnology.com
sales@titaniumtechnology.com
www.facebook.com/titaniumtechnologie

TITANIUM TECHNOLOGY USA
NEWARK DE 19713
Toll free (866)-476-8115 ext.203
www.titaniumtechnology.com
sales@titaniumtechnology.com
www.facebook.com/titaniumtechnologie